



**EXPANDED PUBLIC WORKS PROGRAMME**

# LABOUR INTENSIVE CONSTRUCTION GUIDELINES

for

Water Provision, Sanitation,  
Solid Waste and Building Works



INTERNATIONAL LABOUR ORGANIZATION



EXPANDED PUBLIC WORKS PROGRAMME

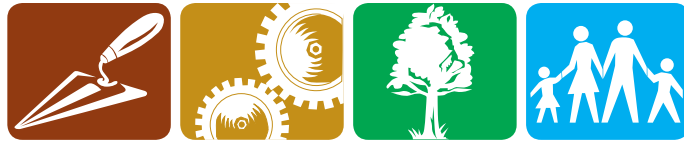

EXPANDED PUBLIC WORKS PROGRAMME

# LABOUR INTENSIVE CONSTRUCTION GUIDELINES

for  
Water Provision, Sanitation,  
Solid Waste and Building Works



INTERNATIONAL LABOUR ORGANIZATION



Copyright © International Labour Organisation 2011

Publications of the International Labour Organisation enjoy copyright under Protocol 2 of the Universal Copyright Convention. Nevertheless, short excerpts from them may be reproduced without authorisation, on condition that the source is indicated. For rights of reproduction, adaptation or translation, application should be made to ILO Publications Branch (Rights and Permissions), International Labour Office, CH-1211 Geneva 22, Switzerland.

---

Labour Intensive Construction Guideline for Water Provision, Sanitation, Solid Waste and Building Works.

*First published 2011*

Produced by ILO Pretoria Office with financial support from the Government of South Africa and the Limpopo Provincial Government.

This document is not for sale.

**ISBN: 978-0-620-46146-7**

---

The designations employed in ILO publications, which are in conformity with United Nations practice, and the presentation of material therein, do not imply the expression of any opinion whatsoever on the part of the International Labour Office concerning the legal status of any country, area or territory or of its authorities, or concerning the delimitation of its frontiers.

The responsibility for opinions expressed in signed articles, studies and other contributions rests solely with their authors, and publication does not constitute an endorsement by the International Labour Office of the opinions expressed in them.

Reference to names of firms and commercial products and processes does not imply their endorsement by the International Labour Office, and any failure to mention a particular firm, commercial product or process is not a sign of disapproval.

*This is not an official ILO document.*

---



## PREFACE



# public works

Department:  
Public works  
REPUBLIC OF SOUTH AFRICA

The Guideline is primarily targeted at Small-Scale Contractors and their Supervisors who are involved in Employment Intensive Infrastructure works including Water Provision, Sanitation, Solid Waste and Building construction. Established Contractors, Professional Engineers, Technologists, Technicians in the Built-Environment and Programme Managers and Planners may also use this book as a reference for some of their employment intensive Design work and Construction Supervision services.

Illustration boxes included herein give real life examples and work methodologies based on universal experience which will assist Contractors to develop effective construction techniques.

Road and Stormwater Drainage works are beyond the scope of this publication. Relevant publications for these works from the International Labour Organisation (ILO) and others should be referenced.

Prepared by: Dingilizwe Tshabalala

Contributors: Augustus Asare  
Asfaw Kidanu  
Htun Hlaing



INTERNATIONAL LABOUR ORGANIZATION



**public works**

Department:  
Public works  
REPUBLIC OF SOUTH AFRICA

## ACKNOWLEDGEMENT

---



**public works**

Department:  
Public works  
REPUBLIC OF SOUTH AFRICA

This Guideline was largely developed from ILO-ASIST publications and adapted to the Southern African context. The ILO-EIIP Technical Assistance Team, South Africa therefore extends its profound gratitude to the authors of these publications and other contributors whose publications were referenced. The support of the Government of South Africa and in particular the National Department of Public Works and Limpopo Department of Public Works were the backbone which facilitated the production of this Guideline. Our profound gratitude extends to them.

## Table of Contents

<b>PREFACE</b> .....	i
<b>ACKNOWLEDGEMENT</b> .....	ii
<b>TABLE OF CONTENTS</b> .....	iii
<b>LIST OF TABLES</b> .....	ix
<b>LIST OF FIGURES</b> .....	x
<b>LIST OF BOXES</b> .....	xii
<b>LIST OF APPENDICES</b> .....	xii
<b>LIST OF APPENDIX TABLES</b> .....	xii
<b>LIST OF ABBREVIATIONS AND ACRONYMS</b> .....	xiii
<b>1. INTRODUCTION</b> .....	1-1
1.1 Target Users .....	1-2
1.2 Scope of the Guideline .....	1-2
1.3 Structure of the Guideline .....	1-3
<b>2. EMPLOYMENT INTENSIVE CONSTRUCTION</b> .....	2-1
2.1 Use of Employment Intensive Methods .....	2-1
2.2 Employment Intensive construction Method .....	2-1
2.2.1 Advantages of Employment Intensive Construction .....	2-2
2.3 EIC Project Selection and Design Principles .....	2-2
2.3.1 Socio-economic Conditions .....	2-2
2.3.2 Environmental Conditions .....	2-2
2.3.3 Availability of Local Labour .....	2-2
2.3.4 Site Conditions and complexity of project .....	2-3
2.3.5 Use of Locally Available Resources .....	2-3
2.3.6 Drawings .....	2-4
2.3.7 Work organization .....	2-4
2.3.8 Pre-manufactured materials .....	2-4
2.3.9 Compaction .....	2-4
<b>3. WATER SUPPLY WORKS</b> .....	3-1
3.1 Introduction .....	3-1
3.2 Planning for Water Supply Schemes .....	3-1
3.2.1 Legal and Regulatory Framework .....	3-1
3.2.2 Economic Considerations .....	3-1
3.2.3 Socio-cultural Considerations .....	3-1
3.2.4 Health Considerations .....	3-2
3.2.5 Technical Considerations .....	3-3
3.3 Water Demand .....	3-3
3.3.1 Domestic Demand .....	3-3
3.3.2 Institutional and Commercial Demand .....	3-4
3.3.3 Industrial Demand .....	3-4



3.4	Water Sources.....	3-6
3.4.1	Existing Sources.....	3-6
3.4.2	New Water Sources .....	3-7
3.5	Protection of Springs.....	3-8
3.5.1	Methods of spring protection.....	3-8
3.5.2	Typical Spring Flow Rates.....	3-9
3.5.3	Stages in the protection of a spring.....	3-9
3.6	Water Treatment.....	3-10
3.6.1	Location of the Water Treatment Works.....	3-12
3.6.2	Labour Intensive Works in Water Treatment Works Construction.....	3-12
3.7	Pipe Routing and Elevations .....	3-12
3.8	Storage.....	3-12
3.8.1	Storage Capacity.....	3-12
3.8.2	Storage Design.....	3-13
3.8.3	Ferrocement tanks .....	3-16
3.9	Materials.....	3-16
3.9.1	Pipes .....	3-16
3.9.2	Construction Works .....	3-17
3.10	Pipeline Construction .....	3-17
3.10.1	Pipeline and Reticulation System design .....	3-18
3.10.2	Flexible Pipe Handling and Storage.....	3-23
3.10.3	Bedding.....	3-23
3.10.4	Pipe Laying.....	3-24
3.10.5	Backfilling and Compaction.....	3-24
3.10.6	Pipe Anchoring .....	3-25
3.10.7	Pressure Testing Procedure .....	3-25
<b>4.</b>	<b>SANITATION .....</b>	<b>4-1</b>
4.1	Planning of Sanitation Systems.....	4-2
4.2	Sanitation Systems.....	4-4
4.3	On site Sanitation Options.....	4-5
4.3.1	Unimproved Pit Toilet .....	4-5
4.3.2	Chemical Toilet .....	4-5
4.3.3	Bucket Toilet .....	4-5
4.3.4	Ventilated Improved Pit Latrines (VIP Latrines).....	4-5
4.3.5	Ventilated Improved Double Pit (VIDP) Latrines .....	4-6
4.3.6	Continuous Composting (CC) Toilets .....	4-6
4.3.7	Pour Flush Pit Latrines .....	4-7
4.3.8	Aqua-Privy Toilets.....	4-7
4.3.9	Septic Tanks .....	4-8
4.3.10	Conservancy Tank.....	4-9
4.4	Off-site Sanitation Options .....	4-10
4.4.1	Conventional Sewer System .....	4-10
4.4.2	Simplified Sewer System.....	4-10
4.4.3	Condominial Sewers .....	4-10



4.4.4	Communal Toilets.....	4-11
4.5	Technical Design Considerations for VIPs.....	4-11
4.5.1	Ground Conditions .....	4-11
4.5.2	Siting of Latrines.....	4-12
4.6	Construction of Household VIP Latrines .....	4-12
4.7	Construction of Septic Tank and Soakaway .....	4-16
4.8	Sewer Construction.....	4-18
4.9	Construction of Stabilisation Ponds.....	4-23
4.9.1	Location of Stabilisation Ponds .....	4-23
<b>5.</b>	<b>SOLID WASTE MANAGEMENT .....</b>	<b>5-1</b>
5.1	Objectives of a Solid waste management System .....	5-1
5.2	Importance of Waste Management .....	5-2
5.2.1	Main Waste Management Options .....	5-2
5.3	The Solid Waste Cycle .....	5-3
5.4	Solid Waste Types and Generation Rates.....	5-4
5.4.1	Household waste.....	5-4
5.4.2	Commercial waste.....	5-4
5.4.3	Industrial waste .....	5-4
5.4.4	Institutional waste.....	5-4
5.4.5	Medical wastes.....	5-4
5.4.6	Street waste and litter.....	5-4
5.4.7	Waste from Agriculture and Forestry (pesticides) .....	5-4
5.4.8	Mining and Power Station Waste .....	5-4
5.4.9	Construction debris .....	5-4
5.5	Waste Management Processes .....	5-6
5.5.1	Waste Minimisation .....	5-6
5.5.2	Recycling.....	5-6
5.5.3	Storage.....	5-8
5.5.4	Collection of Waste .....	5-9
5.5.5	Transportation of Waste .....	5-13
5.6	Community Participation Solid Waste Management .....	5-15
5.7	Skills and Entrepreneurial Development .....	5-16
5.7.1	Challenges for Emerging Enterprises in Waste Management.....	5-17
5.7.2	Creating an Enabling Environment for Emerging Enterprises.....	5-17
<b>6.</b>	<b>SETTING OUT OF WORKS .....</b>	<b>6-1</b>
6.1	Surveying Instruments and Aids.....	6-1
6.1.1	Reference Pegs.....	6-1
6.1.2	Tape Measures.....	6-1
6.1.3	Ranging Rods, Profile Boards and Boning Rods .....	6-2
6.1.4	Line Level.....	6-3
6.2	Setting out Straight Line.....	6-4
6.2.1	Interpolation.....	6-4
6.2.2	Extrapolation .....	6-5
6.3	Setting out Angles .....	6-5





6.3.1 Setting out A right angle ..... 6-5

6.3.2 Setting out a 45° angle..... 6-6

6.3.3 Setting out 30° and 60° angles..... 6-6

6.4 Setting our Gradients ..... 6-6

6.4.1 Checking or Confirming an existing Gradient..... 6-6

6.4.2 Setting out a design gradient..... 6-7

6.4.3 Checking the Uniformity of a Gradient ..... 6-8

**7. SITE CLEARANCE AND EARTH WORKS..... 7-1**

7.1 Site Clearance..... 7-1

7.2 Earthworks ..... 7-3

7.2.1 Excavation of Trenches..... 7-3

7.3 Fills..... 7-4

7.4 Hauling ..... 7-5

7.5 Loading, unloading and spreading ..... 7-6

7.5.1 Loading..... 7-6

7.5.2 Unloading ..... 7-7

7.5.3 Spreading ..... 7-7

7.6 Pipe Laying and Bedding ..... 7-7

7.7 Trench Backfilling ..... 7-8

7.7.1 Bulking and Shrinkage ..... 7-8

7.8 Hard Rock Removal: Blasting Equipment and Procedures..... 7-9

7.8.1 Competence of Workers..... 7-9

7.8.2 Storage of Explosives..... 7-9

7.8.3 Blasting Operations..... 7-9

7.9 Landscaping Operations ..... 7-10

**8. CONCRETE WORKS..... 8-1**

8.1 Concrete Preamble ..... 8-1

8.2 Types of Concrete ..... 8-1

8.3 Concrete Composition..... 8-1

8.3.1 Water..... 8-1

8.3.2 Cement..... 8-2

8.3.3 Stone Aggregate..... 8-3

8.3.4 Sand..... 8-4

8.4 Mixing of Concrete ..... 8-4

8.4.1 Type of Mixes ..... 8-4

8.4.2 Properties of Concrete ..... 8-5

8.4.3 Water-cement ratio..... 8-5

8.4.4 Batching for Concrete Mixing ..... 8-5

8.4.5 Hand Mixing ..... 8-6

8.4.6 Machine Mixing ..... 8-7

8.4.7 Standard field tests..... 8-8

8.5 Transportation of Concrete..... 8-9

8.6 Placing and Compaction of Concrete..... 8-9

8.7 Curing Concrete ..... 8-10



8.8	Concrete Reinforcement .....	8-11
8.8.1	Steel Reinforcement.....	8-11
8.9	Hazards in Handling Concrete .....	8-11
<b>9.</b>	<b>MASONRY WORKS .....</b>	<b>9-1</b>
9.1	Materials for cement bound Masonry .....	9-1
9.1.1	Sand.....	9-1
9.1.2	Cement.....	9-1
9.1.3	Water.....	9-1
9.1.4	Masonry Stone .....	9-1
9.1.5	Bricks.....	9-2
9.1.6	Blocks.....	9-2
9.2	Cement Mortar .....	9-3
9.2.1	Mortar Mixing.....	9-6
9.3	Material Quantities .....	9-6
9.3.1	Joints and Bonding.....	9-6
9.3.2	Common Tools for Masonry Work.....	9-7
9.4	Stone masonry works.....	9-7
9.4.1	Foundations.....	9-7
9.4.2	Joints.....	9-8
9.4.3	Bond.....	9-8
9.4.4	Weep holes .....	9-8
9.5	Brick and block masonry works.....	9-8
9.5.1	Foundations.....	9-8
9.5.2	Joints.....	9-9
9.5.3	Type of Bond .....	9-9
9.6	Plastering .....	9-11
9.7	Painting .....	9-11
9.7.1	Different Types and Characteristics of Paints .....	9-12
9.7.2	Paint Application.....	9-12
9.7.3	Painting Tools.....	9-13
9.7.4	Estimating paint quantities .....	9-13
9.7.5	Painter Productivities.....	9-13
<b>10.</b>	<b>SITE ADMINISTRATION AND WORK ORGANISATION.....</b>	<b>10-1</b>
10.1	Setting up a Camp.....	10-1
10.1.1	Location.....	10-1
10.1.2	Site Supervisory Staff.....	10-1
10.1.3	Labour Recruitment.....	10-1
10.2	Site Support Activities.....	10-2
10.2.1	Drinking Water.....	10-2
10.2.2	First Aid .....	10-3
10.3	Work Organization.....	10-3
10.3.1	Work Programming .....	10-3
10.3.2	Daily Work Planning.....	10-4
10.3.3	Gang Balancing.....	10-4



10.4	Worker's Remuneration and Incentive Schemes .....	10-6
10.4.1	Daily Paid Work.....	10-6
10.4.2	Task Work.....	10-6
10.4.3	Piece Work.....	10-6
10.4.4	Other forms of Payment .....	10-6
10.5	Task Rates.....	10-7
10.6	Inspection and Supervision .....	10-7
10.6.1	Quality Control.....	10-8
10.7	Reporting.....	10-8
<b>11.</b>	<b>CONSTRUCTION HAND TOOLS AND EQUIPMENT .....</b>	<b>11-1</b>
11.1	Specification for Tools .....	11-1
11.2	Procurement of Hand Tools.....	11-1
11.3	Water and Sanitation Hand Tools .....	11-2
11.4	Conventional Equipment .....	11-3
11.4.1	Owning and Operational Costs .....	11-3
<b>12.</b>	<b>TENDERING AND PRICING .....</b>	<b>12-1</b>
12.1	Principles for Cost Estimating .....	12-1
12.1.1	Purpose of Cost Estimation.....	12-1
12.1.2	Cost components .....	12-1
12.2	Pricing .....	12-2
12.2.1	Labour Rate.....	12-2
12.2.2	Tools Rate .....	12-2
12.2.3	Plant Rate.....	12-3
12.2.4	Material and Transport Rate.....	12-3
12.3	Cost Breakdown of Works.....	12-3
12.4	Contract Procedures .....	12-3
12.4.1	Contracting Parties.....	12-3
12.4.2	Tender and Contract Documents.....	12-5
<b>13.</b>	<b>CONSTRUCTION MEASUREMENTS AND CALCULATIONS .....</b>	<b>13-1</b>
13.1	The International System of Units (SI) .....	13-1
13.2	Useful Calculations and Metric Conversions.....	13-1
13.2.1	Length .....	13-1
13.2.2	Velocity.....	13-1
13.2.3	Area.....	13-2
13.2.4	Volume .....	13-4
13.2.5	Mass, Weights and Densities .....	13-5
13.2.6	Pressure .....	13-6
13.2.7	Electricity and Energy.....	13-7
13.2.8	Slopes .....	13-7
<b>14.</b>	<b>REFERENCES .....</b>	<b>14-1</b>
<b>15.</b>	<b>APPENDICES .....</b>	<b>15-1</b>

## List of Tables

Table 1-1:	Target Users .....	1-2
Table 1-2:	Guideline Synopsis.....	1-3
Table 3-1:	Classification of Waterborne Disease.....	3-2
Table 3-2:	Domestic Water Demand Unit Rates.....	3-3
Table 3-3:	Livestock Water Demand Rates .....	3-3
Table 3-4:	Institutional and Commercial Demand.....	3-4
Table 3-5:	Generic uses of Water in Industry .....	3-4
Table 3-6:	Industrial Water Demand Unit Rates .....	3-5
Table 3-7:	Water Demand unit Rates in Selected Mining Industries .....	3-6
Table 3-8:	Water Demand unit Rates in Selected Agro based Industries.....	3-6
Table 3-9:	Water Treatment Selection Criteria.....	3-10
Table 3-10:	Generic Treatment Methods .....	3-11
Table 3-11:	Locating Waterworks far from Consumers .....	3-12
Table 3-12:	Considerations when Sizing Reservoirs .....	3-13
Table 3-13:	Elevated Storage Capacity .....	3-13
Table 3-14:	Recommended Minimum Cover to UPVC Pipe.....	3-24
Table 4-1:	Steps towards successful partnerships .....	4-3
Table 4-2:	Categories of Sanitation Systems.....	4-4
Table 4-3:	Soil Infiltration Rates.....	4-12
Table 4-4:	Labour Requirements for Constructing a Household VIP Latrine.....	4-13
Table 4-5:	Materials for Household VIP Toilet.....	4-13
Table 5-1:	Typical Waste Generation Rates .....	5-6
Table 5-2:	Specific health risks associated with solid waste collection and recycling .....	5-11
Table 5-3:	Street Cleaning Task Rates .....	5-12
Table 5-4:	Transportation options .....	5-13
Table 5-5:	Recommended Hauling Distances of Hauling Equipment.....	5-14
Table 5-6:	Stakeholders Roles and Responsibilities.....	5-15
Table 7-1:	Productivities for clearing and grubbing.....	7-1
Table 7-2:	Classification of In-situ Materials .....	7-3
Table 7-3:	Soil Excavation Characteristics .....	7-4
Table 7-4:	Productivity for excavation.....	7-4
Table 7-5:	Productivity for earth filling.....	7-5
Table 7-6:	Wheelbarrow Haulage Productivity Norm.....	7-6
Table 7-7:	Typical Haulage Rates for Manual Loaded Equipment.....	7-6
Table 7-8:	Loading, Unloading and Spreading Productivity Norms .....	7-7
Table 7-9:	PVC Pipe Laying and Bedding Productivity.....	7-7
Table 7-10:	Bulking and Shrinkage Factors.....	7-9
Table 7-11:	Landscaping Interim Productivity Rates .....	7-10
Table 7-12:	Trench excavation task rates, measured in place .....	7-10
Table 7-13:	Excavation Norms.....	7-11
Table 7-14:	Wheelbarrow haulage norms.....	7-11
Table 8-1:	Strength of Cement versus Shelf Life .....	8-2
Table 8-2:	Different Type of Cements .....	8-3



Table 8-3: Concrete Mix Guide for Different Applications ..... 8-4

Table 8-4: Concrete Mix Guide for Different Grades of Concrete ..... 8-6

Table 8-5: Concrete Mixer recommended Minimum Daily Outputs ..... 8-7

Table 8-6: Comparative Strength of OPC Concrete ..... 8-10

Table 8-7: Formwork Striking off Times ..... 8-11

Table 8-8: Common Hazards of Handling Concrete ..... 8-11

Table 9-1: Available Common Brick Sizes ..... 9-2

Table 9-2: Types and Characteristics of Blocks ..... 9-2

Table 9-3: Sizes of Commonly used Blocks ..... 9-3

Table 9-4: Mortar Mixes for Different Uses ..... 9-3

Table 9-5: Quantities for Different types of Masonry ..... 9-6

Table 9-6: Quantities for Standard Bricks ..... 9-10

Table 9-7: Productivity for Painting ..... 9-13

Table 10-1: Pipe Laying Construction Sequence ..... 10-4

Table 10-2: Reporting Mechanisms ..... 10-9

Table 11-1: Water and Sanitation Hand Tools ..... 11-2

Table 11-2: Conventional Equipment ..... 11-3

Table 12-1: Cost Breakdown of Houses ..... 12-3

Table 12-2: Duties of the Engineer ..... 12-4

Table 12-3: Type of Contractors ..... 12-5

Table 13-1: Base Units ..... 13-1

Table 13-2: Common Length Conversions ..... 13-1

Table 13-3: Common Velocity Conversions ..... 13-1

Table 13-4: Calculations for areas of common shapes ..... 13-2

Table 13-5: Common Volume Conversions ..... 13-4

Table 13-6: Calculations for volume of common shapes ..... 13-4

Table 13-7: Common Mass Conversions ..... 13-5

Table 13-8: Weights of Selected Materials ..... 13-6

Table 13-9: Common Pressure Conversions ..... 13-6

Table 13-10: Symbols and Units of Electrical Power ..... 13-7

## List of Figures

Figure 1-1: Construction Sector: Machine or People ..... 1-1

Figure 2-1: Trenching for water pipe installation ..... 2-1

Figure 3-1: Transmission pathways for and examples of water-related pathogens ..... 3-2

Figure 3-2: An Example of Rainwater Harvesting System ..... 3-8

Figure 3-3: Stage 1: Spring Protection ..... 3-9

Figure 3-4: Stage 2: Spring Protection ..... 3-9

Figure 3-5: Stage 3: Spring Protection ..... 3-9

Figure 3-6: Construction of Clarifier in Vhembe District, RSA ..... 3-10

Figure 3-7: Sectional Steel Ground Reservoirs in North East District, Botswana ..... 3-14

Figure 3-8: A Reinforced Concrete Reservoir under construction in Polokwane, SA ..... 3-15

Figure 3-9: Stored Sewer Pipes ..... 3-23

Figure 3-10: Joining a Socket and Spigot ..... 3-24

Figure 3-11: Pipe Bedding and Backfilling .....	3-25
Figure 4-1: Transmission Route of Diseases .....	4-1
Figure 4-2: Sanitation Strategies.....	4-2
Figure 4-3: Variants of an Unimproved Pit Latrine .....	4-5
Figure 4-4: Ventilated Improved Pit Latrine.....	4-5
Figure 4-5: Ventilated Improved Double Pit Latrine .....	4-6
Figure 4-6: Continuous Compost Toilet.....	4-6
Figure 4-7: Pour Flush Latrine .....	4-7
Figure 4-8: Aqua-privy Latrine.....	4-7
Figure 4-9: Septic Tank .....	4-8
Figure 4-10: Commonly used Water Closets .....	4-9
Figure 4-11: Condominial sewer layout in Petrolina, Brazil.....	4-10
Figure 5-1: Typical Solid Waste Cycle .....	5-3
Figure 5-2: Types of Waste .....	5-5
Figure 5-3: A typical Rural Transfer Station .....	5-9
Figure 6-1: Ranging Rod and Profile Boards .....	6-2
Figure 6-2: Boning Rods .....	6-2
Figure 6-3: Setting out with Boning Rods.....	6-2
Figure 6-4: Setting out level using tube water level .....	6-3
Figure 6-5: Line Level .....	6-3
Figure 6-6: Setting out a straight line with ranging rods (interpolation).....	6-4
Figure 6-7: Setting out a straight line with ranging rods (extrapolation).....	6-5
Figure 6-8: Setting out a right angle.....	6-5
Figure 6-9: Setting out a 45° angle .....	6-6
Figure 6-10: Setting out 30° and 60°.....	6-6
Figure 6-11: Confirming Gradients.....	6-7
Figure 6-12: Setting out Gradient.....	6-8
Figure 6-13: Checking the uniformity of a gradient .....	6-9
Figure 7-1: Site Clearing by Employment Intensive Construction.....	7-2
Figure 7-2: Boulder removal with feather and wedges.....	7-2
Figure 8-1: Concrete Gauge Box .....	8-6
Figure 8-2: Hand mixing of Concrete .....	8-7
Figure 9-1: Brick work in a construction site .....	9-2
Figure 9-2: Typical Stone Masonry Retaining Wall .....	9-7
Figure 9-3: Typical Brick Foundation.....	9-8
Figure 9-4: Brick Footing in Flemish Bond.....	9-9
Figure 10-1: Labour recruitment in Mt. Elgon, Uganda .....	10-2
Figure 10-2: First Aid Officer on site.....	10-3
Figure 10-3: Poorly organized site .....	10-3
Figure 10-4: Well organized site .....	10-3
Figure 11-1: Hydraulic Excavator (TLB).....	11-3
Figure 11-2: Equipment Costing Framework .....	11-4
Figure 13-1: Irregular Polygon .....	13-3
Figure 13-2: Slope Calculation.....	13-7



## List of Boxes

Box 3-1: Extracts from South African Pipeline Design Guidelines.....	3-18
Box 4-1: Extract from South African Sanitation Regulations .....	4-11
Box 4-2: Construction of VIP Latrine .....	4-13
Box 4-3: Constructing a Septic Tank and Soakaway.....	4-16
Box 4-4: Typical Sewer Design Criteria .....	4-18
Box 4-5: Sewer Construction.....	4-19
Box 4-6: Method of Pond Construction.....	4-24
Box 7-1: Fill Construction Work Method.....	7-4
Box 7-2: Pipe Bedding and Backfilling.....	7-8
Box 9-1: Mortar Mixes for Masonry .....	9-4
Box 9-2: Brick Terminology and Types of Bonds .....	9-10
Box 9-3: Productivity for Plastering .....	9-11
Box 10-1: Practical Gang Balancing.....	10-5
Box 10-2: South African Experience in EPWP .....	10-9
Box 12-1: Typical Cost Components .....	12-1

## List of Appendices

Appendix 1: Pipe Specifications .....	15-1
Appendix 2: South African Standard Contract Documents and Specifications.....	15-7
Appendix 3: Pipeworks Pricing Example .....	15-11
Appendix 4: Successful Plastering .....	15-15

## List of Appendix Tables

Appendix 1 Table 1: Supratuff PVC-U Pipes (Wall thickness in mm and mass in kg/m).....	15-1
Appendix 1 Table 2: Ultratuff PVC-A Pipes (Wall thickness in mm and mass in kg/m) .....	15-2
Appendix 1 Table 3: Supramyn Pipes (Wall thickness in mm and mass in kg/m).....	15-3
Appendix 1 Table 4: Maincore PVC-U Sewer Pipes (Wall thickness in mm and mass in kg/m) .....	15-3
Appendix 1 Table 5: Supradur Sewer.....	15-4
Appendix 1 Table 6: Supradrain PVC-U Cable Pipes .....	15-4
Appendix 1 Table 7: Slotted PVC-U subsoil drainage pipes .....	15-5
Appendix 1 Table 8: Maincase PVC-U Borehole Casings.....	15-5
Appendix 1 Table 9: Long Hallmore's SINTAKOTE® Steel pipeline Systems .....	15-6
Appendix 2 Table 1: CIDB Three Volume Tender Document Format .....	15-7
Appendix 2 Table 2: CIDB Single Volume Tender Format.....	15-7
Appendix 3 Table 1: BOQ Extract .....	15-11
Appendix 4 Table 1: Recommended grading for plaster sand .....	15-16
Appendix 4 Table 2: Mix proportions for plaster .....	15-20

## List of Abbreviations and Acronyms

AASHTO	American Association of State Highway and Transportation Officials
ASIST	Advisory Support, Information Services, and Training
BOQ	Bill of Quantities
CBO	Community Based Organisation
CC	Continuous composting
CD4	Cluster of Differentiation 4
CETA	Construction Education and Training Authority (of South Africa)
CGI	Corrugated Galvanised Iron
CIDB	Construction Industry Development Board (of South Africa)
CSIR	Council for Scientific and Industrial Research
CTMP	Chemi-thermomechanical pulp
DFID	Department of International Development (of the United Kingdom)
DCP	Dynamic Cone Penetrometer
DOL	Department of Labour
DPLG&H	Department of Local Government and Housing
DWA	Department of Water Affairs (formerly DWAF)
DWAF	Department of Water Affairs and Forestry
ECC	Engineering and Construction Contract
ECSC	Engineering and Construction Short Contract
EI	Employment Intensive
EIC	Employment Intensive Construction
EIIP	Employment-Intensive Investment Programme
EPC	Engineer, Procure, Construct
EPWP	Expanded Public Works Programme
FBPE	Fusion Bonded Polyethylene
FIDIC	International Federation of Consulting Engineers (Fédération Internationale Des Ingénieurs-Conseils)
GGBF	Ground granulated blast furnace slag
GPS	Global Positioning System
GRP	Glass Reinforced Plastic
HDPE	High-density Polyethylene
IBR	Inverted Box Rib
ILO	International Labour Organisation
JBCC	Joint Building Contracts Committee
LBC	Labour Based Construction
LDPE	Low-density Polyethylene





LDPW	Limpopo Department of Public Works
LIC	Labour Intensive Construction
LOFLOS	Low-flow on-site sanitation systems
NGO	Non-governmental Organisation
NQF	National Qualifications Framework
OPC	Ordinary Portland cement
PI	Plasticity Index
PIG	Provincial Infrastructure Grant
PPE	Personal Protective Equipment
SABS	South African Bureau of Standards
SANS	South African National Standard
SAPPMA	South African Plastic Pipe Manufacturers Association
TWL	Top Water Level
UFW	Un-accounted for Water
UPVC	Un-plasticized Polyvinyl Chloride
VIDP	Ventilated Improved Double Pit
VIP Latrine	Ventilated Improve Pit latrine
wd	Worker days
WEDC	Water, Engineering and Development Centre
WHO	World Health Organisation

## 1. INTRODUCTION

In 2008 an estimated 1.4 Billion<sup>1</sup> people (25% of the world population) were living in extreme poverty<sup>2</sup>. The following summarises what poverty is in actuality:

*Poverty is hunger. Poverty is lack of shelter. Poverty is being sick and not being able to see a doctor. Poverty is not having access to school and not knowing how to read. **Poverty is not having a job**, is fear for the future, living one day at a time. Poverty is losing a child to illness brought about by unclean water. Poverty is powerlessness, lack of representation and freedom.*

Source: World Bank

Unemployment and lack of decent jobs are therefore some of the main drivers of poverty. In 2007 some 3 Billion people aged 15 years and over were employed worldwide whilst 189.9 million were jobless representing 6% unemployment. Of the employed about 486.7 million still live in extreme poverty. In 2008 worldwide unemployment increased to 6.1%<sup>3</sup>. The Global Financial Crisis which was triggered by the crisis in the United States of America's (USA) housing sector in 2007 threatens to render an additional of between 18 and 30 million people being jobless with indications that this figure may grow up to 50 million. From the foregoing it is clear that the fight against poverty is set to be a hard and protracted one.

In Sub-Saharan Africa unemployment was even higher standing at 8.2% in 2007 which is 24.3% higher than in 1997. Of those employed 70% do not have decent jobs and only 25% are salaried and waged workers. Governments in some developing countries have been forced to act as Employers of Last Resort in order to create jobs for the swelling numbers of the jobless. They have adopted Employment Intensive (EI) techniques in various public works programmes in favour of Machine Intensive approaches so as to create the needed jobs. This approach is sustainable and is generally preferred to Government handouts and other social grants.

**Figure 1-1: Construction Sector: Machine or People**



<sup>1</sup> Poverty Net Overview, World Bank.

<sup>2</sup> Extreme poverty refers to people whose level of consumption fell below the international poverty line of \$1.25 per day, in 2005 Purchasing Power Parity terms.

<sup>3</sup> Global Employment Trends, January 2008, ILO



A number of interest groups who are against EI approaches have suggested that infrastructure constructed using this approach is of inferior quality. However, extensive international experience indicates otherwise. Extensive major works and a lot of minor works have been constructed predominantly by EI technology since the 1930s in the Americas, Europe, Asia and Africa. A lot of works in the road sector and other infrastructure assets have been constructed using EI approaches successfully. It is clear from current trends that Governments especially in developing countries will continue to use Public Works programmes to create jobs thus providing social protection to vulnerable groups. A lot of reference materials are available for the road and building sectors but limited in other sectors. This guideline therefore intends to build on the limited material available in the other sectors and provide a Good Practice baseline for EI techniques in Water provision, Sanitation, Solid Waste and Building works.

### 1.1 TARGET USERS

Experience has shown that successful Employment Intensive Investment Programmes (EIIPs) need the cooperation of all spheres of Government and all Stakeholders including Private Sector players. For this to happen effectively, there is need to capacitate key members of staff in all these organizations and ensure that they have the requisite knowledge on EI technology. EI approaches should be included in all stages of the project including at policy formulation level, pre-planning, planning, design, implementation and monitoring and evaluation. Of the players in project implementation, Small Scale Contractors usual lack the resources and skills to implement EI projects successfully yet they have the potential to employ large numbers of people as they have limited access to Capital Equipment. The Guideline is therefore primarily targeted at the Small Scale Contractors. However, a lot of information that can be utilized by Planners, Programme Managers, Consulting Engineers and Major Contractors involved in EI projects has also been included in this guideline. Table 1-1: Target Users shown below gives a full list of users who shall find this guideline useful.

Table 1-1: Target Users

Sector	Target Users
Central Government	<ul style="list-style-type: none"> <li>• Decision Makers</li> <li>• Programme and Project Managers and Planners</li> <li>• Engineers and Technicians</li> </ul>
Provincial and Local Government	<ul style="list-style-type: none"> <li>• Decision Makers</li> <li>• Programme and Project Managers and Planners</li> <li>• Engineers and Technicians</li> </ul>
Non-Governmental Organization Community Based Organization	<ul style="list-style-type: none"> <li>• Programme and Project Managers and Planners</li> <li>• Engineers and Technicians</li> </ul>
Private Sector	<ul style="list-style-type: none"> <li>• Consulting Engineers</li> <li>• Technologist and Technicians</li> <li>• <b>Small Scale Contractors</b></li> <li>• Major Contractors</li> <li>• Tool Suppliers</li> <li>• Precast Concrete Product Suppliers</li> </ul>

### 1.2 SCOPE OF THE GUIDELINE

The Guideline aims to assist users in incorporating and/or implementing EI infrastructure projects. It outlines basic setting out methods, design data, suitable task rates and simplified work methodologies for EI approaches in Water provision, Sanitation, Solid Waste and Building works. Also outlined is a concise overview on work organization and tendering. A chapter on common Construction Measurements and Calculations is also included which also includes unit weights of commonly used construction materials.

The Guideline does not cover Road works. Users interested in EI Road Works design and construction should refer to publications of the ILO and other relevant Institutions.

### 1.3 STRUCTURE OF THE GUIDELINE

The Chapters in this Guide are meant to be by and large all encompassing for each subject. Users can thus benefit from their subject of interest without necessarily reading through the other chapters. However, for users without EI technology experience it is recommended that Chapters on Introduction, Employment Intensive Construction, Site Clearance and Earthworks; Construction Hand Tools and Equipment; and Construction Measurements and Calculations be appreciated as well.

Table 1-2 below gives a synopsis of the individual chapters of the Guideline.

**Table 1-2: Guideline Synopsis**

Chapter	Description	Overview
Chapter 1	Introduction	This Chapter gives an introductory overview of the Guideline. The global situation with regards to unemployment and poverty is given. The target users are then listed followed by a concise scope of the document.
Chapter 2	Employment Intensive Construction	This Chapter gives a background of the Employment Intensive Approach including its advantages. It further outlines how suitable projects which are amenable to the methodology can be identified.
Chapter 3	Water Supply Works	A brief overview of generic planning requirements is given. Typical Water Demand data for domestic, institutional, commercial and industrial consumers are tabulated. Typical considerations for development of water sources are suggested with focus on protection of natural springs using EI approaches. Works that can be implemented by EI technologies are identified.  A synopsis of requirements for design of reservoirs is given coupled with EI construction of Ferro cement tanks. Detailed work methodologies in EI construction of water pipes are presented.
Chapter 4	Sanitation	The chapter gives an overview of generic planning requirements for sanitation schemes. Various technological options for on-site and off site systems are discussed. Detailed methodologies for the EI construction of VIP latrines, Septic Tank systems, sewers and Waste Stabilisation Ponds are given.
Chapter 5	Solid Waste Management	The chapter gives options for waste management, classification of solid waste and processes for waste disposal with emphasis on EI approaches. Approaches to community participation and small to medium scale Entrepreneurial involvement in management is suggested.
Chapter 6	Setting out of Works	This chapter focuses on tools and aids used in EI projects. Methods of setting out straight lines, bends and gradients are also given
Chapter 7	Site Clearance and Earthworks	This chapter focuses on EI aspects of site clearance and earthworks. An overview of removing hard rock by blasting is also given. Taskwork rates for typical landscaping operations are also suggested.
Chapter 8	Concrete Works	This chapter gives an overview of different types of cements and concretes. Concrete materials, composition and mix designs are explained detail. Methodologies of producing concrete by hand and by machine are explained. Good practice in transporting, placing, compaction and curing of concrete is outlined. Proper guidelines for use of Steel Reinforcement are also given.
Chapter 9	Masonry Works	This chapter provides a useful guide to brick, block and stone masonry. Mortar mix designs are outlined. Methods of taking off quantities are given together with recommended work methodologies. A concise guide to plastering is given and so is a brief guide to determining paint quantities.
Chapter 10	Site Administration and Work Organisation	This chapter discusses Camp Establishment, support activities, work organisation, remuneration schemes and work supervision.



<b>Chapter</b>	<b>Description</b>	<b>Overview</b>
<b>Chapter 11</b>	Construction Hand Tools and Equipment	This is a brief overview of Specifications for Hand Tools and recommended procurement procedures. Use of conventional and light equipment is briefly discussed. Detailed information on Hand Tools and Equipment can be obtained from publications from the ILO and other relevant institutions.
<b>Chapter 12</b>	Tendering and Pricing	This is a brief overview of Tendering and Pricing. Detailed information on Tendering, Pricing and Estimating can be obtained from other publications from the ILO and other relevant institutions.
<b>Chapter 13</b>	Construction Measurements and Calculations	The chapter provide background data on units, conversions and unit weights. This information is important to assist implementers in task setting and ascertaining feasibility of using labour in transporting and placing various materials.
<b>Appendix 1</b>	Pipe Specifications	This gives weights and dimensions of selected commonly used Pipes. This will assist users to determine whether or not the selected pipes are EI friendly in terms of handling.
<b>Appendix 2</b>	South African Standard Contract Documents and Specifications	This gives an overview of commonly used Standard Contract Tender Documents and Specifications for Civil Works.
<b>Appendix 3</b>	Pipeworks Pricing Example	This is a detailed example for pricing for EI constructed pipeworks.
<b>Appendix 4</b>	Successful Plastering	The Guideline produced by the Cement and Concrete Institute of South Africa is reproduced in full in this appendix.

## 2. EMPLOYMENT INTENSIVE CONSTRUCTION

### 2.1 USE OF EMPLOYMENT INTENSIVE METHODS

This basically involves the use of innovative methods in executing projects or product manufacture in order to maximize employment and also transfer skills to the target worker groups without compromising the final asset or product quality. In infrastructure projects, these are achieved by using Employment Intensive Construction (EIC) method/technology. Other reference materials refer to this as Labour Based Construction (LBC) whilst some especially in South Africa refer to this as Labour Intensive Construction (LIC). In this document these terms may be used interchangeably.

**Figure 2-1: Trenching for water pipe installation**



### 2.2 EMPLOYMENT INTENSIVE CONSTRUCTION METHOD

Employment-intensive construction (EIC) methods involve the use of an appropriate mix of labour and capital equipment in construction of infrastructure and assets, with a preference for labour where technically and economically feasible, without compromising the quality of the assets. Preference is also made for light capital equipment. International and local experiences have shown that, with well-trained supervisory staff and an appropriate employment framework, employment-intensive methods can be employed successfully for certain types of infrastructure projects without compromising quality.



The success of EIC projects can be evaluated in part by the proportion of the project expenditure that ends up as wages for unskilled workers and low level skilled ones. In projects whereby the bulk of the works involve earthworks which can be constructed using EIC methods such as low volume road construction, wages can account for up to 30% of the project expenditure with significant local economic benefits, and up to about 80% in routine road maintenance works. In other infrastructure construction such as water provision, sanitation and building works, high cost of materials such as piping, pumps, bricks and so forth may account for a large proportion of project expenditure. In these works successful EIC projects wages can account for 10 to 20% of the expenditure. In normal conventional non EIC projects wages still account for approximately 5 to less than 10% of the project expenditure.

### 2.2.1 ADVANTAGES OF EMPLOYMENT INTENSIVE CONSTRUCTION

The benefits of the use of EIC methods compared to using the conventional machine methods are numerous, amongst others include:

- Creates employment for local people
- Gives opportunities to women and youth. This provides social security protection net to vulnerable groups
- Creation of local entrepreneurs especially Small, Medium and Micro Enterprises
- Promotes local economic development and livelihoods especial in rural areas where economic activities are limited
- Mitigates rural-urban migration
- Skills transfer to workers (essential for routine maintenance of asset by labour)
- Instills a higher sense of ownership of infrastructure to local communities
- Requires fewer skilled operators
- Optimization of the use of local resources
- Many work sites can be operated concurrently thus dispelling the myth that 'EIC is slow'
- Projects are less dependent on foreign exchange
- Provision of infrastructure in areas where it is not feasible to bring in and/or use conventional machinery such as mountainous areas, deep valleys, informal settlements

## 2.3 EIC PROJECT SELECTION AND DESIGN PRINCIPLES

Projects to be selected and designed for EIC should satisfy the following basic criteria and principles:

### 2.3.1 SOCIO-ECONOMIC CONDITIONS

When implementing EIC projects certain conditions should prevail for these projects to be successful. For instance labour should be the predominant resource, thus such projects cannot succeed in sparsely populated areas or those areas where unemployment is low. Conversely where there is dense population, high unemployment, underemployment, low wage rates and high levels of poverty EIC approach will be ideal. Currently a daily wage rate of US\$15.00 per task is the break even point above which Capital Intensive projects become more economically viable. However, Governments may still proceed with EIC projects even if market wages are high as long as the social benefits outweigh the other considerations.

### 2.3.2 ENVIRONMENTAL CONDITIONS

Environmental conditions should also be considered, for example in extremely cold or extremely hot areas it may not be feasible to carry out EIC projects. In areas with extreme rainfall and those with high water tables EIC may not be feasible.

### 2.3.3 AVAILABILITY OF LOCAL LABOUR

The project location should be in close proximity (say within walking distance of maximum 5km radius) of large settlements where abundant labour supply can be obtained. Absence of abundant labour within the project vicinity can result in increased project costs (in transportation/ accommodation) and administration.

### 2.3.4 SITE CONDITIONS AND COMPLEXITY OF PROJECT

The nature and scope of the project should not be too sophisticated and difficult. EIC is not quite conducive for very hard/rocky ground conditions such as steep terrain as well as for infrastructure works involving massive earthworks, which may require heavy machines. Care must also be taken in the selection of construction materials to ensure quality and durability of infrastructure works.

For trench works EIC is conducive for excavations not exceeding 1.5 metre depth.

### 2.3.5 USE OF LOCALLY AVAILABLE RESOURCES

The selection of construction materials during design should emphasize more on materials that will maximize employment creation during construction; and the design should optimize the use of locally-available materials. For example stone masonry and grouted stone pitching should be included wherever suitable materials are available. Where local skills are available for example bricklayers, structures should be designed to make maximum use of such skills. A project can specify brick manholes in favour of precast concrete ones in order to harness available skills. Consideration must be given to alternative design of trench excavation by hand, for gravity pipelines via reduction in depth of excavation. The following tips should be considered in design of infrastructure projects with the objective of maximizing employment creation:

- Minor earthworks must be designed EIC. In trench excavation efforts should be made to encourage reuse of excavated materials in order to limit haulage distances.
- Vertical and horizontal alignment of the works should be such as to optimize cut and fill, minimize deep or hard excavation or areas requiring specialist engineering input for example dewatering or specialist ground stabilization. Trench excavation by hand should be limited to maximum of 1.5m depth. Where the soils are loose efforts should be made to support the vertical excavated faces to prevent collapse or caving in of soils on the workers.
- Suitable construction material should be sourced as far as is possible in close proximity to the site of the Works. In trenching the survey should ensure soil sampling should be undertaken, and standard identifier tests as well as Dynamic Cone Penetrometer (DCPs) must be performed in order to determine suitability of the in-situ materials for bedding and backfilling. This will assist to ascertain the need for additional imported material in order to meet the specification.
- The distance between quarries or sand sources should preferably not exceed 4 to 5km, whereby the use of small volume local transport, should be considered. All efforts must be made to identify new material sources rather than relying only on existing ones with due care for the minimization of environmental damage.
- For borrow pits and sand sources earmarked for excavation by EIC methods, samples from the sources should be taken by digging test pits if necessary in a 10m x10m grid pattern throughout the entire area of the borrow pits, and to place concrete beacons at the perimeters of the area for ease of identification and direction for working of the quarry. The findings of the material testing should be presented in a standard format documenting:
  - o The location and extent of the source;
  - o The thickness and properties (hardness, stone content) of the overburden;
  - o The thickness and properties of the seam (hardness, stone content, standard test results) and total volume to be extracted from the quarry;
  - o Recommendations on methods for working of the quarry including feasibility for excavation by hand.
- Street sweeping and waste collection services should as far as is feasible be undertaken using EIC approaches.





### 2.3.6 DRAWINGS

Drawings must be produced and presented in a clear easily understandable format. Where setting out information is provided in the form of coordinates it should be backed up with methods, not relying on sophisticated surveying instruments, such as offsets measurable with the use of a standard tape. Where possible and appropriate drawings should be produced using a background of ortho/aerial photos to provide for easy identification of surrounding features. Except in special circumstances, drawings should be produced in a form that is easily readable in A3 format.

### 2.3.7 WORK ORGANIZATION

The work organization and spacing of workers must be such as to ensure safety in the work area. Design considerations like benching, terracing etc. should be applied to excavation in material which may constitute a safety hazard for workers. If these measures cannot be taken, then such works must be excluded from EIC activities.

### 2.3.8 PRE-MANUFACTURED MATERIALS

All pre-fabricated components which are incorporated into the Works must be sized such that the mass of each individual element does not exceed 320kg. Hazardous materials must not be included in the Works. For example flexible piping is light and labour friendly compared to concrete pipe with similar hydraulic properties.

### 2.3.9 COMPACTION

Compaction by hand rammers should be limited to very restricted and small confined areas e.g. in narrow trenches and behind structures. Where compaction of wide areas is required, it must be carried out at the required moisture content using conventional compaction equipment (mechanized pedestrian rollers where possible) to ensure achievement of the required compaction densities.

## 3. WATER SUPPLY WORKS

### 3.1 INTRODUCTION

Water is a precious resource and vital for life. Access to a safe and affordable supply of drinking water is a pre-condition for the development of human livelihoods. Water shortage, poor water quality or unreliable supply has profound adverse effects on the well-being of people. Safe and reliable water supply in combination with appropriate sanitation facilities prevents transmission of waterborne diseases.

Water is supplied for Domestic, Agricultural, Landscaping, Commercial, Industrial, and Institutional use. Supply of safe water for domestic use normally includes water for: drinking, food preparation, bathing, laundry, dishwashing and cleaning. Agricultural use may be targeted for use by livestock and for watering vegetable plots, and gardens crop irrigation. Water may also be used to irrigate public and private gardens, parks and other places of aesthetic beauty. Commerce and Industry also have unique water needs. Industries can be classified as water based such as beverage and food manufacturers whilst others such as cement manufacturers may have minimal water needs.

### 3.2 PLANNING FOR WATER SUPPLY SCHEMES

The Planners should look at water provision holistically in an effort to ensure that the current beneficiaries receive an acceptable service that is value for money at the same time ensuring that the infrastructure performs to acceptable standards over its lifetime. Planning should encourage water conservation, sustainability and consideration for future generations.

In addition, planning should reflect the national policy priorities such as poverty reduction and employment creation, and the socio-economic needs of the population served.

#### 3.2.1 LEGAL AND REGULATORY FRAMEWORK

There are specific requirements, guidelines and national laws regarding safe water (quality) and accessibility (distance to nearest water point). Planning and implementation should therefore consider all these requirements and ensure that the proposed schemes conform to all Legal requirements.

#### 3.2.2 ECONOMIC CONSIDERATIONS

Provision of water is costly and it is therefore important that Planners be cognisant of this and should strive to minimize the lifetime cost of the infrastructure. Using relevant economic tools several suitable options should be costed with due consideration being given to the construction costs, operational costs (Maintenance, power, Manpower, etc.) to determine which scheme has the most optimal lifetime cost.

#### 3.2.3 SOCIO-CULTURAL CONSIDERATIONS

Generally acceptable practice suggests that the beneficiaries of the envisaged water service should be involved in the planning and decision-making processes. This will ensure that their preferences are incorporated into the design. Some communities have deep cultural beliefs. For example if one locates a water point in a certain area not acceptable to the community they may opt not to use it. Generally involvement of the communities will ensure that specific needs are addressed and in particular interests of the vulnerable groups including, women, children and people with disabilities will be catered for. In addition community participation ensures ownership, maintenances and protection of public assets.

In most communities local level institutions are available to assist in development issues, mobilization of communities and facilitation of programme implementation.



### 3.2.4 HEALTH CONSIDERATIONS

The ultimate goal of planning for water provision is to provide water in sufficient quantities that is free from waterborne diseases and safe for human consumption. Recent studies indicate that waterborne diarrheal diseases world-wide cause 4% of all deaths and 5% of health loss due to disability<sup>4</sup>. They kill about 2.2 million people globally each year, mostly children in developing countries. The need to provide water in adequate quantities and of acceptable potable quality thus cannot be overemphasized. Waterborne diseases can be broadly classified as per Table 3-1 below:

**Table 3-1: Classification of Waterborne Disease**

Type of water related infection	Examples	Water-related control measures
Faecal-oral diseases	<ul style="list-style-type: none"> <li>• diarrhoea</li> <li>• typhoid</li> <li>• hepatitis</li> <li>• cholera</li> </ul>	<ul style="list-style-type: none"> <li>• increase water quantity used</li> <li>• improve water quality</li> </ul>
Strictly water-washed	<ul style="list-style-type: none"> <li>• scabies</li> <li>• trachoma</li> <li>• conjunctivitis</li> </ul>	<ul style="list-style-type: none"> <li>• increase water quantity used</li> </ul>
Water-based (intermediate host)	<ul style="list-style-type: none"> <li>• guinea-worm</li> <li>• schistosomiasis</li> </ul>	<ul style="list-style-type: none"> <li>• restrict contact, provide alternative sources</li> </ul>
Water-related insect vectors	<ul style="list-style-type: none"> <li>• malaria</li> <li>• filariasis</li> <li>• river blindness</li> </ul>	<ul style="list-style-type: none"> <li>• focus on insect breeding sites (not much scope in domestic water supply)</li> </ul>

Source: DFID

World Health Organization (WHO) also classifies Bacteria, Viruses and parasites (Protozoa and Helminths) that cause waterborne diseases as shown in Figure 3-1. The protozoa cryptosporidium parvum is particularly difficult to remove from water networks as it is resistant to chlorine, a common disinfectant used in water treatment. Immuno-compromised patients with especially AIDS patients who have CD4 counts below 50 cells/mm<sup>3</sup> are particularly susceptible to cryptosporidiosis. Some studies have found that cryptosporidiosis affects 10 to 15% of the AIDS patients, causing death in 50% of the cases.

**Figure 3-1: Transmission pathways for and examples of water-related pathogens**

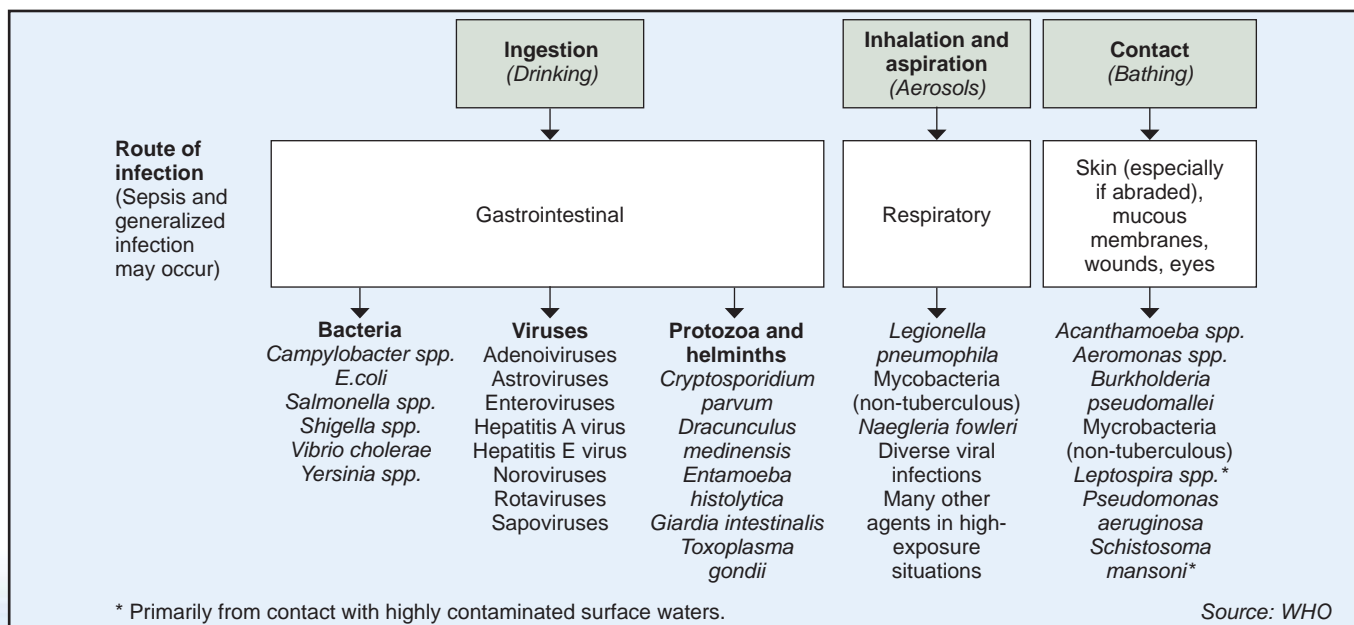

<sup>4</sup> WHO website www.who.int

### 3.2.5 TECHNICAL CONSIDERATIONS

Technical considerations are pivotal to the success of a project. Factors that need careful consideration include:

- Estimation of Water demand over a suitable design life;
- Evaluation of existing water sources, water supply, storage and distribution;
- Identification of suitable additional water sources with adequate water and acceptable quality;
- Selecting Treatment processes and identifying a site for the Water Treatment works;
- Design of water sources, water supply, storage and distribution;
- Survey pipe routing and trench lines;
- Identifying Reservoir sites;
- Review implementation technologies including Employment Intensive Methods;
- Producing Technical Reports and Budget Estimates;
- Producing Tender Documents, Tendering and producing Contract Documents;
- Project Implementation and Management;
- Planning and organisation of operation and maintenance; and
- Monitoring and Evaluation.

## 3.3 WATER DEMAND

It is important to estimate with reasonable accuracy the water demand over the design life of the proposed water system. Demand (current and projected) for water is primarily dependent on population, level of economic development, change in land use and settlement patterns. Population projections should consider natural growth, death, migrations and so on. Unit water demand should also consider economic and social development issues over the design period.

### 3.3.1 DOMESTIC DEMAND

Table 3-2 below is a summary of unit demand rates developed in South Africa. In rural areas allowance can be made for livestock as indicated in Table 3-3.

**Table 3-2: Domestic Water Demand Unit Rates**

Description	Unit	Typical Consumption	Range
Standpipe (200m walking distance)	l/cap.d	25	10 - 50
Yard Connection	l/scap.d	55	50 - 100
With dry Sanitation			30 - 60
With Low Flow on site Sanitation Systems (LOFLOS)			45 - 75
With Full-flush sanitation			60 - 100
House Connection (Developed Areas)	l/cap.d	80	60 - 475
Development Level: Moderate			48 - 98
Moderate to high			80 - 145
High			130 - 280
Very high			250 - 480

Source: CSIR

**Table 3-3: Livestock Water Demand Rates**

Type	Unit	Typical Consumption
Large Stock (Meat Industry)	l/head.d	50
Large Stock (Dairy Industry)	l/head.d	120
Small Stock	l/head.d	12

Source: CSIR



### 3.3.2 INSTITUTIONAL AND COMMERCIAL DEMAND

Table 3-4 below is a guide for Institutional and Commercial demand unit demand rates as suggested by CSIR.

**Table 3-4: Institutional and Commercial Demand**

Description	Unit	Typical Consumption	Range
Schools: Day	l/pupil.d		15 - 20
Boarding			90 - 140
Hospitals:	l/cap.d		220 - 300
Clinics: Outpatients	l/cap.d	5	
Inpatients	l/cap.d		40 - 60
Bus Stations (transit passengers only)	l/cap.d	15	
Community Halls/Restaurants	l/seat.d		65 - 90
Hotels	l/bed.d	250	
Offices and shops	m <sup>3</sup> /ha.d	40	

Source: CSIR

### 3.3.3 INDUSTRIAL DEMAND

Industrial water demand is variable and thus can only be reliably estimated by considering each industry on case by case basis, for example Beer, Soft Drink and Steel industries have high water demand whilst industries manufacturing electronic equipment have low water demands. When providing water infrastructure planners may not have full details of the industries that will be developed in the planning area. As a rough guide 5 to 10 m<sup>3</sup>/ha.day can be used as water demand for light industries whilst 15 to 25 m<sup>3</sup>/ha.day can be used for heavy industries. Water based industries will need special consideration. Degremont suggest that water in industry is generally used as indicated in Table 3-5 below.

**Table 3-5: Generic uses of Water in Industry**

Use	Generic Applications
Steam	Boilers, air humidifiers.
Heat exchange	Condensation of steam, cooling of fluids and solids, heating, aqueous cutting fluids.
Gas scrubbing	Steel industry, incineration of household refuse, desulphurisation of smoke.
Washing of solids; Transport of solids; Surface rinsing; Transport of ions	Coal, ore, agricultural products, Paper pulp, coal, pulp, agrifood industry, electrophoresis pigments, Surface treatment, semiconductors, microelectronics, dye works, agrifood industry, Surface treatment baths.
Quenching	Coke, slag, granulation of cast iron.
Maintaining pressure	Secondary recovery of oil.
Kinetic energy	Descaling steel, granulation (slag, scarfing).
Manufacture	Beer and carbonated drinks.

Source: Degremont Water Treatment Handbook

If details of proposed industries are known Consultants may be engaged to provide services for the design of the infrastructure. The Tables below (Table 3-6 to Table 3-8) are a guide for water demands for selected industries.

**Table 3-6: Industrial Water Demand Unit Rates**

Type	Unit	Typical	Demand Range	Use
<b>Breweries*</b>	m <sup>3</sup> water per m <sup>3</sup> of beer		5 - 6	Brewing of beer, Washing of bottles, vats, equipment and brewing floors; cooling
<b>Carbonated Drinks *</b>	m <sup>3</sup> water per m <sup>3</sup> of drink		3	
<b>Sorghum Malting**</b> (Medium to Large Maltsters)	m <sup>3</sup> water per tonne of malt	3.3	2.5 - 10	
<b>Sorghum Beer Breweries **</b>	m <sup>3</sup> water per m <sup>3</sup> of beer	2.5	2.3 - 4.8	
<b>Dairy Industries *</b>	m <sup>3</sup> water per m <sup>3</sup> of milk		4.5 - 8	Disinfecting of equipment and tanks; Cleaning the grounds; washing the products; reconstituting milk; cooling
<b>Textile Industry *</b>				
Degreasing of wool	m <sup>3</sup> water per tonne of finished product		20 - 40	Boilers; manufacturing; air humidification and dust removal.  (This represents 80% of the total water requirements of the textile industry)
Finishing and dyeing of wool			70 - 200	
Finishing of cotton and synthetic fabrics			100	
Dyeing and Printing of Knits			70	
<b>Pulp and Paper Industries *</b>				
<b>Pulp Production</b>	m <sup>3</sup> water per tonne of pulp			Steam production; pulp preparation; making of paper and transport of fibres
Unbleached kraft			25 - 60	
Bleached kraft			40 - 80	
Bleached sulphite			80 - 150	
Semi chemical			12 - 20	
Chemi-thermomechanical pulp (CTMP)			12 - 25	
De inking	m <sup>3</sup> water per tonne of finished product		50 - 80	
<b>Paper production</b>	m <sup>3</sup> water per tonne of paper			
Kraft paper			20 - 40	
Newsprint			40 - 60	
Fine quality			40 - 100	
Cardboard/packaging			3 - 40	
<b>Brick Production **</b>	m <sup>3</sup> water per tonne of brick		15 -30	
<b>Cement Manufacture **</b>	m <sup>3</sup> water per tonne of cement	3.8		
<b>Concrete Products **</b>	m <sup>3</sup> water per tonne of product	1		
<b>Reinforced Concrete **</b>	m <sup>3</sup> water per m <sup>3</sup> of concrete	0.63		



Table 3-7: Water Demand unit Rates in Selected Mining Industries

Type	Unit	Typical	Demand Range
<b>Coal Mining: **</b> Shafts	m <sup>3</sup> water per tonne		0.33 - 0.45
Open Cast	m <sup>3</sup> water per tonne	0.11	
<b>Diamond Mining: **</b>	m <sup>3</sup> water per tonne		0.3 - 0.5

Table 3-8: Water Demand unit Rates in Selected Agro based Industries

Type	Unit	Typical	Demand Range
<b>Bread Production **</b>	m <sup>3</sup> water per tonne of product		2 - 6
<b>Refined Sugar beet **</b>	m <sup>3</sup> water per tonne of product	9	
<b>Baked Beans **</b>	m <sup>3</sup> water per tonne of product	20	20 - 70
<b>Edible Oil: **</b> Milling	m <sup>3</sup> water per tonne of product	2.6	2.1 - 3.1
Refining	m <sup>3</sup> water per tonne of product	3.8	3.2 - 4.6

Notes to

Table 3-6 to Table 3-8:

\* Source: Degremont Water Treatment Handbook

\*\* Source: HR Wallingford Handbook for the Assessment of Catchment Water Demand and Use

In industry water recirculation and reuse can reduce the gross water demand markedly and this should be regulated and enforced in all new industrial developments.

### 3.4 WATER SOURCES

#### 3.4.1 EXISTING SOURCES

An initial evaluation of the existing water sources should be undertaken and this will determine whether there is need or not for new sources. The process should generally involve the following:

- **Information Collection and Collation:** All stakeholders should be consulted from the Relevant Department of Central Government, Local Authorities right down to water operators and beneficiary communities.
- **Reconnaissance of Water sources:** The Planner should gain knowledge of the local sources. For example answers to questions like:
  - o Are the rivers perennial or ephemeral?
  - o Are the existing dams silted or are they overgrown with hyacinth?
  - o Is the dam structure sound?
  - o Can the boreholes/wells supply water throughout the year?
  - o How many months of the year can rain water harvesting systems be relied upon?
  - o Is the water quality acceptable?
  - o What is the available yield? and so forth.

Recent Satellite and aerial photographs can be used in this exercise.

### 3.4.2 NEW WATER SOURCES

When selecting the new water sources the quantity and quality of the available water should be considered. Developing a few water sources that will have adequate yield for a reasonable period may be preferred to developing many small sources from a budgetary perspective. Good quality raw water reduces routine treatment costs. Underground water normally requires less treatment than surface water. For small communities preference should be given to underground water. Note that groundwater may take a long time to recharge in dry and arid areas and this must be considered in planning and design. The following activities need to be undertaken:

- Carry out a sanitary survey to determine the reliability of a water system to continuously supply safe and adequate water to the consumer.
- Interpret the results of water analysis and the effects of actual and potential sources of pollution on water quality.
- Identification of potential pollution sources which might influence the water source or distribution system, such as sewage and waste disposal systems, bathing areas and storm water drains, etc.
- Carry out water sampling and analysis according to the type of water source investigated. Chemical and bacteriological quality of the water should be determined at this stage.
- Selection of Treatment Processes and determination of treatment costs.
- Approve the optimal water source.

Water sources may be of any of the following types:

**Ground water:** Ground water infrastructure includes:

- o **Large Diameter Wells:** Normally water is collected by manual means from wells. In some instances it may be feasible to equip wells with pumps.
- o **Tube Wells:** These are normally installed in sandy soils where hand excavation is not feasible.
- o **Boreholes:** The Borehole Report should include the Map Number and Grid Reference for ease of location by the contractor. The Internal Diameter of the Borehole and Casing should be stated. The pump should be installed at 2m to 3m above the bottom of borehole to avoid pumping of settled sediments.
- o **Springs:** should be developed to ensure minimal or no environmental damage. The abstraction should take into account the minimum yield of the dry season.
- o **Sand Abstraction:** Abstraction points should be located at points where sand bed is thick say about 1m to 5m.

The quality of groundwater depends on the thickness and type of the soil stratum which covers (overburden) the water bearing geological formation. It is also dependent on the chemical and mechanical properties of the water bearing strata. This is important to know because of the indirect contamination from latrines, fertilisers, disposal sites and industrial activities. The quantity depends on the annual rainfall, condition and storage capability of the ground.

**Surface water:**

This is water from dams/lakes, directly from streams, rivers as well as water confined within rainwater catchment basins found in the sand sub-layers of rivers or similar. The quantity must be determined from assessment of volume flow or storage capacity. The quality depends on the activities associated with the area concerned such as: the socio-economic development of the community, industrial, and agricultural discharge into the water source. Surface-water supplies are all subject to continuous or intermittent pollution and must be treated accordingly.

**Rainwater harvesting:**

This is the direct collection of rainwater from surfaces. The water is led into storage and used by households and community institutions. Normally the storage tank is sufficient for serving a house or an institution and therefore no distribution system is required. The Figure 3-2 below illustrates a typical rain water harvesting system from a roof top.





Figure 3-2: An Example of Rainwater Harvesting System

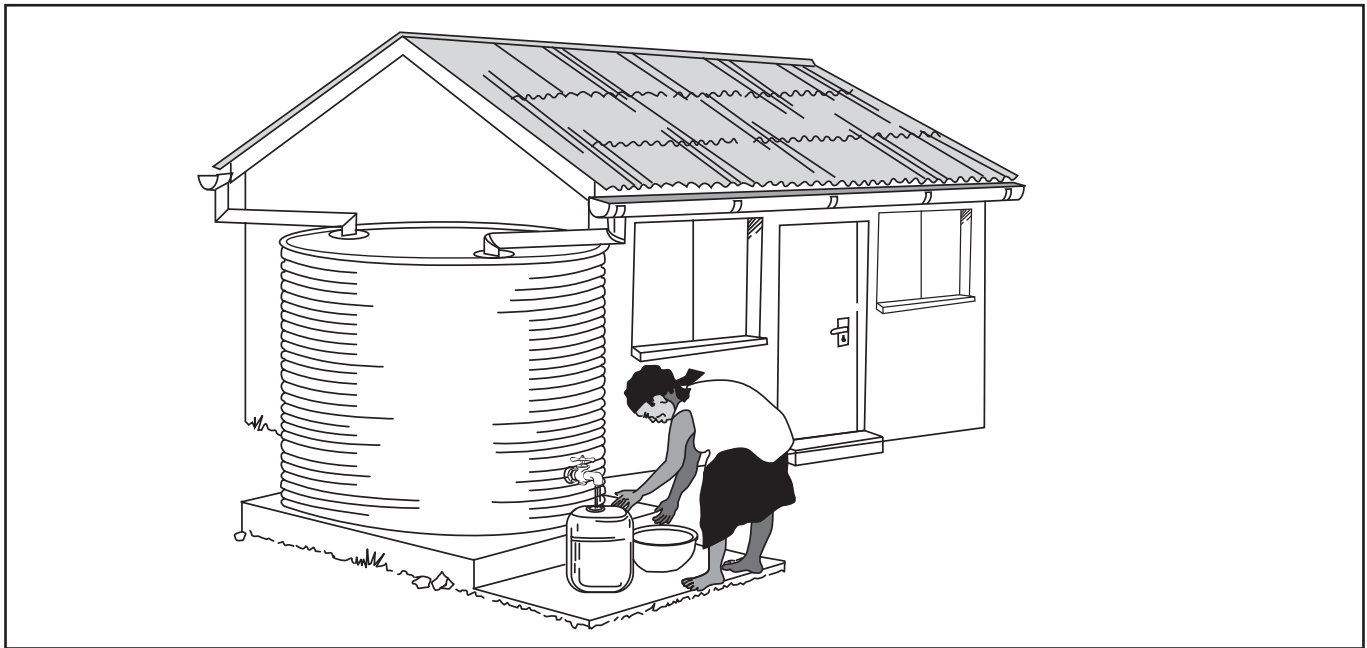

### 3.5 PROTECTION OF SPRINGS

Surface springs occur where groundwater emerges at the surface because an impervious layer of ground prevents further seepage downwards. The rate of flow of water from the spring will vary with the seasons. It is necessary to measure the spring's flow at the end of the dry season to determine its potential reliable yield.

An inspection of the ground upstream of the spring is essential to ascertain that there is no risk of pollution or, if there is, measures can be taken to prevent it.

A spring source can be used either to supply a gravity scheme or just to provide a single outlet, running continuously, which is set at a sufficient height to allow a bucket or container to be placed below it. To prevent waste, any flow which is surplus to that required for domestic use can be used for irrigation purposes.

If the flow from the spring is not sufficient to meet peak demands during the day, a storage tank can be incorporated into the structure of the spring protection. This enables the flow from the spring over the full 24 hours to be stored and then used throughout the day to meet intermittent demands by means of a tap in the structure.

#### 3.5.1 METHODS OF SPRING PROTECTION

There are many different methods of getting the clear spring water from its source into the bucket or reticulation system. The primary objective is to protect the spring water from pollution, and to ensure that it is easy to collect by consumers.

The following should be considered when investigating a potential spring source:

- Making sure that the spring is not really a stream which has gone underground and is re-emerging;
- Making sure that the source and the collecting area are not likely to be polluted by surface runoff;
- Checking that there are no latrines within 50 metres upstream of the spring;
- Fencing the area around the spring tank to prevent pollution by people or livestock;
- Making sure that if the spring is to be connected to a piped water system it is on higher ground than the area to be supplied;

- Taking care that the spring tank is not built on swampy ground or on land which is subject to erosion or flooding and that the flow from the protected spring itself will not cause erosion or damage.
- Ensuring that the spring does not undermine the slope stability of the area as this may lead to landslides.

### 3.5.2 TYPICAL SPRING FLOW RATES

A flow in excess of 0.1 litres per second is sufficient to fill a 20 litre container in just over 3 minutes, which is an acceptable waiting time. From such a spring a daily useful yield of about 3000 litres can be expected, which is enough water for about 15 households.

If the flow were to be only 0.05 litres per second it could still be made to supply the same population by incorporating a storage tank of 1 cubic metre capacity.

If the flow were to be 0.5 litres per second or more the source would be suitable to supply multiple outlets or a piped gravity scheme.

### 3.5.3 STAGES IN THE PROTECTION OF A SPRING

The following three diagrams illustrate the stages in the construction of a collecting chamber:

**Stage 1** is a plan view, showing:

- A cut-off drain to divert surface water;
- Clearance of vegetation above the eye of the spring;
- A temporary diversion of the spring water to allow construction of the collection chamber.

Figure 3-3: Stage 1: Spring Protection

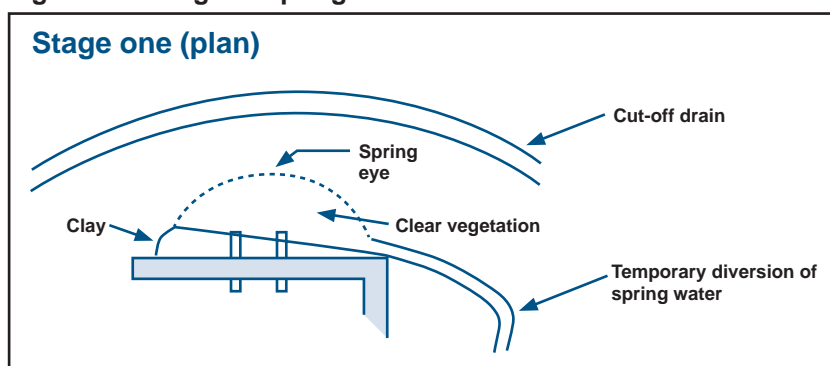

**Stage 2** is a plan view, showing:

- Large stones placed above the eye of the spring;
- The construction of the collection chamber.

Figure 3-4: Stage 2: Spring Protection

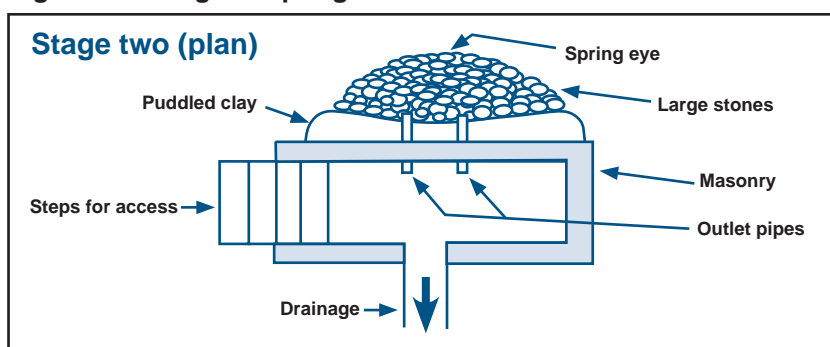

**Stage 3** is a cross-section of the finished scheme, showing:

- Further protection of the eye by layers of impervious material above it.
- Fencing of site

Figure 3-5: Stage 3: Spring Protection

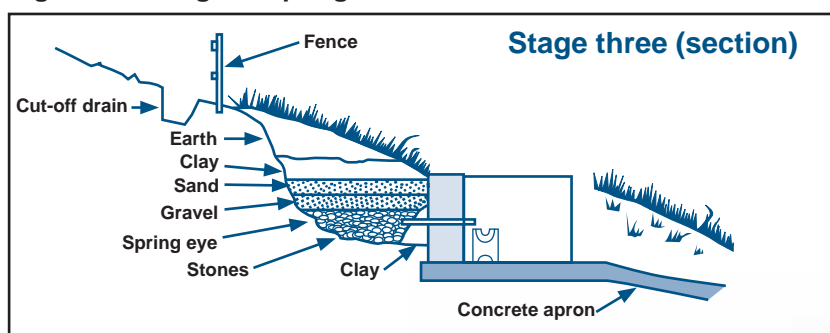

Source: WaterAid

In view of the isolated and confined location of springs, it is recommended that clearance and earthworks for collection chambers and protection works must ideally be undertaken using employment intensive methods.



### 3.6 WATER TREATMENT

Water sources must be tested to ascertain that they meet the minimum quality required. If the water is not of an acceptable quality it must be treated to achieve the required safety and environmental standards.

The water quality at source will to some extent dictate the need for treatment before distribution. The target quality of the water should be as set by the relevant bodies that regulates the water sector.

Table 3-9 gives a guide for required water Treatment based on the untreated water quality:

**Table 3-9: Water Treatment Selection Criteria**

Raw Water Quality	Treatment Suggested
Turbidity 0 - 5 NTU Faecal Coliform 0/100 ml Guinea worm or schistosomiasis not endemic	• No Treatment
Turbidity 0 - 5 NTU Faecal Coliform 0/100 ml Guinea worm or schistosomiasis endemic	• Slow Sand filtration
Turbidity 0 - 20 NTU Faecal Coliform 1 - 500/100 ml	• Slow Sand filtration • Chlorination if possible
Turbidity 20 - 30 NTU Up to 30 NTU for a few days only Faecal Coliform 1 - 500/100 ml	• Pre-treatment advantageous • Slow Sand filtration • Chlorination if possible
Turbidity 20 - 30 NTU Up to 30 NTU for several weeks Faecal Coliform 1 - 500/100 ml	• Pre-treatment advisable • Slow Sand filtration • Chlorination if possible
Turbidity 20 - 150 NTU Faecal Coliform 500 - 5000/100 ml	• Pre-treatment • Slow Sand filtration • Chlorination if possible
Turbidity 30 - 150 NTU Faecal Coliform > 5000/100 ml	• Pre-treatment • Slow Sand filtration • Chlorination
Turbidity >150 NTU	• Detailed Investigation (and possible pilot-plant study)

Source: CSIR

**Figure 3-6: Construction of a Clarifier in Vhembe District, RSA**



Water quality can best be assured by maintaining water clarity, a chlorine residual in the distribution system, confirmatory absence of bacterial indicator organisms and low bacterial population in the distributed water. Common Treatment methods are outlined in the Table 3-10 below.

**Table 3-10: Generic Treatment Methods**

Process	Effect	Design	Notes
Pretreatment with Chlorine	Reduce organic loads, protect raw water transfer system	Chlorination or hypochlorous acid or Chlorine dioxide	
Screening	Remove larger particles, rags, bottles, etc. at intakes.	Substantial bar (25mm) size and 25-50mm spacing Band screens of 6mm holes.	Inclined to provide easy cleaning by rake. Band and drum screens can be cleaned by water jets
Micro-strainers	Screening stored water without a large amount of suspended matter, but which might contain plankton, algae, and other microscopic sized particles.	Wire fabric with fine mesh 23-35 microns.	Lake supplies and large storage water.
Preoxidation	Oxidation of ferrous ions, removal of excess O <sub>2</sub> , H <sub>2</sub> S and CO <sub>2</sub> , improve taste,	Water Cascades; water spray; chlorination,	
Sedimentation and settling tanks	Permit suspended solids to settle outwater by gravity.	Settling test will determine the tank size, the need for chemical assisted sedimentation (coagulation and flocculation to form a precipitate).	Chemical(s) dosed according to water's initial colour and content of solids. Sludge must be removed regularly.
Rapid Sand Filtration for removal of settleable and unsetttable solids	Removal of particles by physical action, although Physiochemical considerations may enter.	Usually sand is the filter media including grain sizes from 0.4 to 1.5 mm.	Backwashing needed for cleaning
Slow Sand Filtration	Removal of particles by biological and physical action, disinfection		For low Turbidities.
Aeration	Increase the dissolved oxygen content, reduce tastes and odours caused by dissolved gases, decrease CO <sub>2</sub> content and thereby the corrosiveness, convert iron or manganese in soluble form.	Weirs and waterfalls may serve as aerators, beds of coke, limestone and anthracite also is used specially for CO <sub>2</sub> removal. Spray, injection and surface aerators are also used.	
Disinfection	Reduction of organisms in water including bacteria, viruses, cysts, protozoa, worms and larvae to such levels that no infection of disease results.	Commonly by tropical chloride of lime (TCL) or calciumhypochlorite, also UV radiation, iodine, potassiumpermanganate or boiling can be used on a small scale.	The disinfection of water is a subject of some complexity and further study is required for the choice of a disinfectant and its efficiency.

Source: CSIR



### 3.6.1 LOCATION OF THE WATER TREATMENT WORKS

It may so happen that water sources are located far away from the service area. In this case the Planners have to decide whether to locate the Treatment works near the water sources or near the consumers. The advantages and disadvantages of locating the works near the sources are listed in the Table below.

Table 3-11: Locating Waterworks far from Consumers

Advantages	Disadvantages
<ul style="list-style-type: none"> <li>• Smaller untreated water storage requirements.</li> <li>• Untreated water has higher concentration of sediments and is more expensive to convey. It is cheaper to convey treated water.</li> <li>• Relative ease of disposing of wastes.</li> </ul>	<ul style="list-style-type: none"> <li>• Unaccounted for Water (UFW) of treated water is more expensive.</li> <li>• Risk of Contamination in transmission to demand zone.</li> <li>• Need for Workers' permanent housing at the works.</li> <li>• High Administrative costs associated with need for Managers to visit works</li> <li>• The need to develop costly infrastructure to support the works.</li> <li>• Challenges to attract suitable skills to remote areas.</li> </ul>

### 3.6.2 LABOUR INTENSIVE WORKS IN WATER TREATMENT WORKS CONSTRUCTION

Water Treatment Plants are usually complex installations requiring specialist skills to construct. However, Planners, Consultants and Contractors should take cognisance of national employment creation objectives, and the fact that unskilled workers can be gainfully employed in general civil works related to treatment works. Access roads, water/sewer service pipework, electrical reticulation, office Buildings and housing are some of the installations in a waterworks which can absorb unskilled workers including:

- Site clearance
- Access roads
- Water/sewer service pipeline
- Electrical reticulation
- Office building and housing
- Fencing

These are some of the installations in a waterworks which can absorb unskilled workers.

## 3.7 PIPE ROUTING AND ELEVATIONS

This refers to locating the most economical and technically feasible alignment of pipelines from source right up to the end-users. A topographic survey has to be done along the proposed main pipeline routes to establish long section and distances along the pipe route. The type of terrain to be traversed has to be investigated in order to know the various quantities of material to be excavated. Reference points have to be permanent or semi-permanent to be able to easily identify them for re-surveying. Longitudinal sections are generally not required for reticulation pipework. These are generally laid at specified depths adequate for traffic protection. When laid at shallow depths pipe protection is normally required.

## 3.8 STORAGE

### 3.8.1 STORAGE CAPACITY

Water is normally stored in suitable holding capacity before transfer and distribution. The main reason for construction of storage reservoirs is to allow for fluctuations in consumer demand. It also allows for ample time for maintenance when there are breakdowns at the Treatment works or pumping system without interrupting service to consumers. This tends to optimize on the size of the Treatment works and pumping system. The Reservoir also provides a fairly

constant residual pressure and flow to consumers. It also provides reserve capacity for fire fighting. Reservoirs should ideally be located as near as possible to the consumers so as to minimize lengths and sizes of distribution mains.

The following should be considered when determining the storage capacity as shown in Table 3-12.

**Table 3-12: Considerations when Sizing Reservoirs**

Considerations	Reasons
Access to alternative sources	Areas which can be fed from (an) alternative water source(s) from their primary source can afford to have minimal reservoir storage as the risk is lower for all supply sources to have a breakdown at the same time.
Capacity of standby pumps	Reliable standby pumps with adequate capacity lower risk of supply thus allowing construction of minimal storage capacity.
Alternative Power Sources	Alternative power sources for pumping systems lower risk thus allowing construction of minimal storage capacity.
Distance of Installation from potential Maintenance Service Providers	Remote areas usually require larger storage as downtimes may be longer as resources are being mobilized and spares are being transported to site.
Fire Fighting capacity required	In areas of high fire risks such as informal settlements, industries and also areas with expensive infrastructure (industries, commercial centres and high cost housing) storage should be adequate for fire demand during emergencies.
Demand trends over the design periods	Areas with unusually high peak demands usually require large storage in order to cope with this peak demand at the same time allowing optimal design for supply pipelines. This is critical in areas where sources and treatment works are located far from the areas served.

There are basically two types of storage reservoirs namely ground and elevated reservoirs. Ground Storage is usually sized at 48 hours of annual average daily demand. The following storage capacities are usually adopted for elevated storage:

**Table 3-13: Elevated Storage Capacity**

Pumping Plant Serving the Installation	Capacity in Hours of Instantaneous peak demand
One electrically driven duty pump plus one identical Electrically driven standby pump, plus standby power generation independent of the electricity supply.	2 hr
One electrically driven duty pump plus one identical Electrically driven standby pump.	4 hr

### 3.8.2 STORAGE DESIGN

#### Location of Service Reservoirs

A service reservoir should be located in such a way that it is able to adequately serve the entire targeted service area. Ideally it should be centrally located at a higher altitude so as to provide adequate pressure to all consumers.



## Types

Reservoirs can be constructed in various shapes and from various materials depending on capacity and availability of materials. The types of reservoirs based on the materials employed in their construction are as listed below:

- Precast Concrete
- Reinforced Brick
- Reinforced Concrete
- Corrugated Galvanised Iron (CGI)
- Fibreglass
- Sectional Steel
- Ferrocement

**Figure 3-7: Sectional Steel Ground Reservoirs in North East District, Botswana**



## Roofing of Reservoirs

All drinking water reservoirs have to be roofed to avoid contamination. CGI, Fibreglass and Sectional Steel tanks are manufactured complete with roofs. Brick reservoirs can be roofed using Inverted Box Rib (IBR) sheets. Concrete reservoirs are usually roofed by employing a concrete slab. The Top Water Level should be at least 300mm below the roof soffit to allow for ventilation.

## Inlet Pipe

The inlet pipe should be located opposite to the outlet (diagonally opposite in rectangular reservoirs) so as to avoid short circuiting . It should also be at the same level with overflow outlet. An access manhole should be located on the roof above the inlet for ease of maintenance.

## Outlet Pipe

The outlet invert should be at least 100mm above the floor level of the reservoir to avoid settled suspended solids from being drawn from the reservoir. It should be located relative to the inlet so as to avoid short circuiting<sup>5</sup>. Depending on the design it may at times be necessary to install a non-return valve or an air valve on the outlet pipe.

## Overflow Pipe

The purpose of the overflow is to protect the reservoir from overtopping. The overflow should be sized in such a way that its capacity is equal or greater than the inlet capacity. It should be located in such a way that the Top Water Level (TWL) is maintained at 300mm below the roof.

<sup>5</sup> Short circuiting occurs when incoming water leaves the reservoir ahead of water already in the reservoir and this result in stagnation, stale water and sedimentation.

### Scour Pipe

The purpose of the scour pipe is to rid reservoirs of sediments that settle over time in the reservoir. It should take off at the lowest point of the reservoir. Normally the minimum size of the scour pipe should be 100mm diameter.

### Sub-floor Drainage

An appropriate subsurface drainage should, if feasible, be constructed to prevent buoyancy when the reservoir is empty. Alternatively in untreated water reservoirs pressure relief devices discharging into the tank may be employed.

### Reservoir Ventilation

Inverted U-shaped pipes with appropriate screens are normally installed on reservoir on reservoir roofs for ventilation. As a guide two 150mm diameter ventilators should be provided for every 1,000m<sup>3</sup> of water stored.

Figure 3-8: A Reinforced Concrete Reservoir under construction in Polokwane, SA



### Access Ladders

Access ladder should be provided for ease of access and maintenance.

### Fencing

All reservoirs should be fenced by a minimum 2.1 metres diamond mesh reservoirs with barbed wire. If expensive equipment such as pumps and generators are installed at the site, other security measures such as electric fencing and alarms should be considered.

### Access Roads

Access roads to reservoirs should have a maximum gradient of 10% so as to afford ease of access to heavy delivery trucks. For accesses with no major earthworks, use of Employment intensive construction methods is strongly recommended.





### 3.8.3 FERROCEMENT TANKS

Ferrocement ground level tanks are constructed with a plain or reinforced concrete base, cylindrical walls of ferrocement and a roof of ferrocement or IBR sheeting.

The construction of ferrocement walls is carried out by first assembling a cylindrical mesh of chicken wire and/or fence wire reinforcement, with or without the aid of formwork. On to this, a cement-rich mortar of 3:1 (sand : cement) is applied by trowel and built up in layers of about 15mm to a finished thickness of between 30mm to 100mm, depending on wall height and tank diameter. Thicker walls may have two layers of mesh. The mesh helps to control local cracking and the higher walls may call for the provision of small diameter vertical steel reinforcing bars for bending resistance. Sometimes barbed fence wire is wound spirally up the wall to assist with resistance to ring tension and stress distribution.

Effective curing of the mortar between the troweling of each layer is very important and affects the durability of the material and its resistance to cracking. Mortar should be still fresh when the next layer is placed. This means that the time gap between layers should be between 12 and 24 hours. The finished material should then be cured continuously for up to 10 days under damp hessian, or other sheeting. A ferrocement tank is easy to repair and, if the mortar has been properly applied and cured, should provide long service as a water-retaining structure at a fraction of the cost of a reinforced concrete structure.

**Note that the above construction procedure is purely employment intensive in nature and should be constructed as such. Applicable task rates are indicated in Chapters 7 and 8.**

## 3.9 MATERIALS

Apart from pipes, valves and fittings all structures in water supply projects require the use of block, bricks, cement mortar and plaster as well as concrete for floors and slabs for valve chambers and Pump houses.

### 3.9.1 PIPES

The appropriate pipes to be used for a water supply system depend on the local standards used and the availability of pipe material, sizes and classes. The main requirements for a pipeline are that:

- It must convey the required quantity of water at peak demand;
- It must not contaminate the conveyed water;
- It must resist all external and internal forces/pressure; and
- It must be durable.

#### Iron and steel pipes and their fittings

Pipes are manufactured in cast iron, ductile iron and galvanized iron. Galvanized iron pipes are primarily used in the various tanks and tap-stands of the system, especially for sections which have excessively high pressure, are exposed or have earth cover. Most steel pipes are supplied in lengths of 6 and 9 metres. Smaller diameters have screwed joints. Untreated black steel pipes can be bent to curves on a portable bending machine and are useful for residential and rugged areas as well as for internal fittings. Larger steel pipes are normally coated with Portland cement or bituminous enamel. Steel pipes of diameter of up to 200mm in 9m long or shorter lengths can be successfully laid by hand.

Flange joints must be carefully aligned before bolts are inserted and flanges pulled together to complete the jointing. There are also other types of joints available. The most common is the O-ring joint. See Appendix 1 for selected steel pipe Specifications.

### Flexible Pipes

Flexible pipes are manufactured in both solid and fibre-reinforced materials. These include Unplasticised Polyvinyl Chloride (uPVC) pipes, high density Polyethylene pipes (HDPE), glass reinforced plastic (GRP) pipes. Such pipes are widely used both in domestic plumbing and in water distribution since they are far easier to handle, install and are generally cheaper than traditional materials such as iron or concrete. Small diameter plastic pipes <110 mm are joined by solvent welding in cylindrical sleeves. Large diameter lines have bell and spigot push-on connections and are compatible with cast iron fittings. HDPE are black plastic pipes, light and flexible, resistant to abrasion and corrosion. This pipe is normally used for underground service pipes as the smaller diameter pipe is flexible. The strength is reduced with increasing temperature. Joints are either metal or plastic compression couplings or butt/sleeve welding. See Appendix for uPVC pipe sizes, dimensions and masses.

### Concrete Pipes

Concrete pipes are manufactured with or without reinforcing wire depending on pressure class. One type of pipe that is used extensively is prestressed concrete pipes that are made by tensioning high tensile wire wound spirally around a cylindrical core. They can offer a cost advantage over other pipes in sizes over 300mm. They are resistant against certain corrosive conditions that would attack iron and steel, although they do need special protection if the groundwater is saline or otherwise aggressive to concrete. They have little flexibility at joints. The large diameter pipes are very heavy and difficulty will occur when aligning them in soft ground. Connections are not easy to make after the pipe has been laid and tees have to be incorporated as the line is laid. Joints are usually of the socket and spigot O-ring push-in type or concentric circular steel rings sealed with rubber gaskets.

### Asbestos Cement Pipes

Asbestos pipes are made of Portland cement and asbestos fibre. Asbestos fibres can be carcinogenic (cancer causing) and such pipes are therefore not used or are being phased out in most countries. Iron fittings with rubber rings are used in jointing these pipes. Pipes can be interchanged with iron pipes.

## 3.9.2 CONSTRUCTION WORKS

Before starting site operations for water supply schemes there are some other activities which must be carried out in order to allow for smooth operation on site.

These are the support activities and usually consist of:

- Technical/Design report, Engineer's Estimate and Tender/Contract Document and Bill of Quantities:
- Camp Establishment: This refers to an actual site camp or established facilities in urban areas. The camp must have adequate storage (tools and materials), offices and space for parking and maintenance of equipment. Adequate security should be provided for the camp.
- Water supply: Provision of adequate supply of potable water for workers. This is also a support activity.
- Electrical power: Depending on the pipe material selected, electrical power might be required for fitting the pipe sections.

## 3.10 PIPELINE CONSTRUCTION

The pipeline construction work can be subdivided into the following activities:

- Setting out pipeline trenches
- Site clearing
- Removal of waste and obstructions
- Locating and marking existing service lines
- Trench excavation
- Trench bed preparation
- Construction of Chambers and Appurtenances
- Pipe laying on trench beds



- Pressure testing of sections
- Trench backfilling and compaction
- Pipeline marking
- Disinfecting pipelines

Provided site conditions (terrain, vegetation and soil) and the scope of works allow, all efforts must be made to make use of Employment intensive methods for the above activities which optimizes employment creation, skills transfer and injects the needed capital into the local economy.

### 3.10.1 PIPELINE AND RETICULATION SYSTEM DESIGN

Many methods are currently being employed in the design of water pipe systems. Computer programs are available commercially and in a limited free of charge. Whatever approaches are employed the design seeks to achieve serviceability for the design life of the system. Box 3-1 below gives an overview of design requirements for pipelines recommended for South Africa.

#### Box 3-1: Extracts from South African Pipeline Design Guidelines

##### Pipeline materials

The pipeline material that provides the lowest life cycle cost should be selected. The selection procedure as proposed in **Section 3 of Darling and Hodgson’s “Pipe Selection Manual, 1996”** is recommended.

Suitable pipeline materials are tabulated below:

Pipe Materials, Classes and Acceptable Sizes:	DWAF DWS Specification	Class (bar)	Sizes (mm)
Minimum pipe size for reticulation: 50mm nominal diameter			
HDPE (SANS 533)	None	Min. Class 6	15 - 75
uPVC (SANS 966 or ISO 4422)	DWS 1160	Min. Class 6	50 -250
Note: 125 and 140 mm sizes are not recommended for uPVC pipes, due to the lack of standard fittings.			
21GRP	DWS 1150	Min. Class 6 Max. 25 bar	Min. 150
Galvanised Mild Steel (SANS 62)	None	Medium Duty	15 -150
Steel (> 150mm)	DWS 1130	Min. API 5L Grade A Min. wall thick. t = 4,5 mm Slenderness, D/t < 120	Min. 200
Max. Press. incl. surge (m) = 120*t/D, where S = Yield Point Stress (MPa) and D = Outside Dia (mm). Formula assumes max. of 60% of yield stress mobilised.			
Protection to steel pipes (> 150 mm):	Generally bitumen fibre wrap coating with cement mortar lining or epoxy lining and cathodic protection – see DWS 1131.		

##### Pipeline velocities

The following maximum and minimum pipeline velocities are recommended:

- Minimum Raw water: 0,6 m/s
- Minimum Treated water: 0,3 m/s
- Maximum DPFR for Reticulations: 1,5 m/s
- Maximum Pump suction inside station: 2,0 m/s
- Maximum Design flow in Bulk Supply: 3,0 m/s
- Maximum Scour flow in Pipelines: 5,0 m/s

### Pipe friction factors

Only Colebrook-White or Darcy-Weisbach formulae (with friction factor,  $f$ , determined using Moody diagram or equivalent formula); or Hazen-Williams formula, with C factor equivalent to  $k_s$  for pipe diameter and velocity, are acceptable for design.

Pipe friction factors are provided in the table below:

#### Pipe Friction factors (Absolute Roughness, $k_s$ , mm)

Type of Pipes	Pipelines (excl. fittings losses)	Reticulation (incl. fittings losses)
uPVC or GRP	0,06 mm	0,10 mm
Steel (cement mortar lined)	0,20 mm	0,26 mm

### Depth of pipe cover

The minimum depths of cover to main pipelines are:

- Generally: 600mm
- Under cultivated land: 900mm
- Road/Railway crossings: 1000mm

Additional protection should be provided to pipes under roads or railways where required.

### Vacuum pressures

Vacuum pressures in Bulk Supply Pipelines during shutdown and scouring of pipes are generally unacceptable, but 3 metres maximum is acceptable to economise on Double Orifice Air Valve installations.

### Cover

750mm minimum cover with 1000mm cover required under road crossings.

### Trench width

Allow for at least the pipe diameter plus 150mm on both sides for small diameter pipelines to ensure that backfilling is effectively rammed. The minimum trench width should be 500mm.

### Bedding and backfill (including material)

According to SANS 1200 and DWS 1110 (see Specification Folder) where applicable.

### Slope

A slope of steeper than 0.3% is required to avoid air pockets.

### Meters

Schemes should be provided with bulk metering from the water source.

The supply to each local authority should be separately metered.

All stand pipes should be measured.

Where house or yard connections are provided, the consumption of each individual household should be measured.

### Delivery point

For a basic level of service in rural communities the delivery point should be the stand pipe or a yard tank.



### Pipe markers

Refer to DWS 1110 in Specifications Folder.

Pipe markers are required at a minimum spacing of 500m unless the pipeline follows a road.

All bends should be marked.

Air release and air intake valves

Air valves should be provided on summits of main lines.

Air intake valves are required upstream and downstream of isolation valves on ascending and descending pipeline slopes respectively.

The minimum distance between air valves should be 500m.

Separate isolating valves are required on each air valve branch for maintenance purposes.

Refer to **Messrs. Mulric Hydro Projects' catalogue No. RBX 0001** for the selection and positioning of air valves.

Diameter of branch below air valve should be as follows:

- Pipeline  $\leq$  200 mm NB: Install an equal T piece below air valve.
- Pipeline  $>$  200mm NB: The branch pipe must be as large as practically possible with a maximum diameter of 600mm NB for all pipelines  $>$  600mm NB.

### Scour valves

Should be provided at all low points.

Scour valves should be so sized that the pipe can be drained between the isolating valves within two hours.

The diameter of the drainpipe should be 0.4 times the diameter of the main pipe but should be an equal T for pipelines  $\leq$  200mm NB.

### Isolating valves

Should be placed:

- At all pipeline intersections in the branch and main line.
- At an approximate distance of 1.5km, preferably at the lowest points.
- Start of every rising main with arrow pointing towards the pumping station.
- At the end of every gravity main with arrow on valve pointing in flow direction.
- Isolating valves should be mounted with flange adapters to aid in removal.

### Valve chambers

Valve chambers of robust construction should be provided for all valves.

Valve chambers must be properly ventilated with vermin proof fixed GMS or 3CR12 louvered ventilators.

Sufficient access should be provided in valve chambers for the removal of bolts.

The cover should be 700mm above ground level and should be of a hinged and non-removable type.

A sump should be provided for dewatering.

The chamber should be secure against vandalism.

### Pressure control valves

Pressure control valves are not favoured and their use should be minimised.

Break pressure tanks should be used for pressure reduction where possible, but the correct placing of reservoirs is preferred.

### Thrust blocks and anchors

Coupled pipelines must be anchored at:

- All changes of direction greater than 10 degrees.
- At changes in pipe size.
- At slopes greater than 1:6.
- At blank ends.
- The anchor blocks must be large enough to:
  - Provide sufficient friction and bearing forces between the anchor block and soil to balance the thrust force in any direction; and
  - Balance upward forces through the mass of the block.

The pipe should be imbedded at least up to the centre line at bends.

A flexible membrane should be inserted between the pipe and anchor block to prevent damage to pipes subject to chafing.

### Structural design

Pipelines should be designed for internal and external pressure including surge pressure.

The structural load bearing capacity of the pipe is specified by the manufacturer and care should be taken not to expose the pipe to loading conditions other than that intended by the manufacturer.

### Corrosion protection

Refer to DWS 1131 in Specifications Folder.

### Couplings

Two major categories are generally used, namely rigid and flexible joints.

Flexible joints are defined as those joints that allow some telescopic movement or angular flexure of the adjoining pipes.

### Rigid couplings/joints

#### Flanges

Flanges should be attached to pipes by metal-arc welding, the weld preparation being in accordance with the requirements of BS806 Type 6 unless otherwise specified.

A slip-on welded flange is suitable for all design pressure conditions covered by BS flange tables up to and including Table-J and design temperatures not exceeding 425°C, with pipes 80 mm and over.

Flanges should be in accordance with BS 4504.

#### Welded butt joints

Butt joints welded by the metal-arc process should be in accordance with the requirements of DWS 1130 and DWS 1110.

#### Screwed couplings

Pipes should be screwed taper and sockets parallel thread according to SANS 1109 or ISO 7/1.

Galvanized pipes may be threaded after galvanizing.

The use of parallel threads on light pipes are not recommended.

### Flexible couplings

All flexible coupling should be able to withstand an internal pressure equal to or greater than the design working



pressure of the pipe. The couplings should be able to withstand any external pressure due to installation conditions without the presence of an internal pressure.

Spigot and socket joints utilizing a rubber ring as a seal should be watertight under working pressure with a shear force equal to the expected external load applied to the coupling.

Rubber O-rings used for sealing should not elongate more than 25% of the original length when stretched over the spigot end of a pipe. See BS 2494.

Rubber o-rings should not be exposed to ultra-violet radiation or ozone for periods longer than the time required for installation.

Where a pipeline is likely to be subjected to any abnormally corrosive condition, the pipe manufacturer should be contacted in advance so that they may advise on the suitability of their joints for the purpose, or alternatively in collaboration with their rubber supplier, provide rings that will meet the requirements of the situation.

Sleeve type joints using a flexible plastic sleeve must conform to the misalignment test according to the relevant SANS standard for that specific type of pipe utilizing the coupling.

The draw and slew movement of the coupling will be in accordance with the requirements of the relevant SANS standard for that specific type of pipe utilizing the coupling.

## Fittings

### Reducers / diffusers and inlets

The range of angle of deflection for concentric or eccentric diffusers (enlarging diameter) should be between 2.5 – 30 degrees.

Where available NPSH is a problem, rounded inlets should provide better flow characteristics and less friction losses.

### Bends

Refer to **DWS 1130**.

Elbows should not have a bending radius smaller than the outside diameter of the pipe.

Medium and long radius bends should not have a radius larger than seven times the outside diameter of the pipe. Long radius bends normally have a radius of approximately three times the outside diameter of the pipe.

Standard angles of elbows are: 90, 45 and 22.5 degrees.

### Dividers

All flow dividers will cause change in flow direction and should therefore be properly anchored.

Standard angles of deviation from the main pipe are: 90, 60, 45, 22.5 and 11 degrees.

### Puddle or thrust flanges

Puddle or thrust flanges should be provided where a pipe passes through a water retaining structure or chamber.

A thrust flange will assist in the transfer of axial pipe forces due to water hammer or surges.

The flange should be designed structurally to withstand the shear forces it will experience.

Steel pipelines should be insulated with paint where they pass through concrete.

### Reinforced specials

The procedures developed H.S. Swanson *et al* have been incorporated into AWWA M11 - Steel pipe - A guide for design and installation, and are generally used in the design of reinforced specials.

### Pipeline specifications

The following DWAF specifications are applicable to pipelines and are included in the *Specifications Folder*.

DWS 1110	Construction of pipelines
DWS 1130	Design, manufacture and supply of steel pipes
DWS 1131	Lining and coating of steel pipes and specials
DWS 1140	Design, manufacture and supply of asbestos-cement pressure pipes and joints
DWS 1150	Glass reinforced plastics (GRP) pipes and joints for use for water supply
DWS 1160	Design, manufacture, supply, and installation of Polyvinyl Chloride (PVC) Pressure Pipes and fittings
DWS 2510	Supply of valves

### 3.10.2 FLEXIBLE PIPE HANDLING AND STORAGE

Plastic pipe in particular semi-rigid pipes like uPVC can easily be damaged during transportation. They can develop latent damage which can result in failure during testing and thus should be handled with care. The pipes are generally susceptible to heat and ultra violet rays and thus should be protected from direct sunlight at all times. UPVC pipes' tensile strength declines markedly at about 60°C and their rigidity falls sharply at temperatures above 70°C.

To avoid damage the pipes should be supported in storage by supports with a minimum thickness of 100mm at a spacing of 1m or less. The pipes should be stacked in no more than six layers. Pipes may be stacked in timber frames on top of each other as long as no individual pipe carries a load of more than five pipes. Small pipes can also be nested inside larger pipes. For Labour based works it is recommended that the stacked pipes in timber frames should not exceed a maximum height of 3.0 metres so that they can be easily stacked and un-stacked with minimal risks of accidents.

**Figure 3-9: Improper storage of sewer pipes. Ideally, shade should be provided.**



Source: Petzetakis

### 3.10.3 BEDDING

The quality of the bedding material and its compaction, together with the nature of the undisturbed material of the trench walls are all relevant to the ultimate performance of pressure pipes once installed. The trench bed must be free from all oversized stones or sharp projections which are likely to cause damage to the pipe. The bottom of the trench should be backfilled to a depth of 100mm, with selected bedding material such as free drainage coarse sand, gravel or solid of a friable (easily breakable) nature. The size of soil particles in the bedding material should not exceed 20mm. The bedding onto which the pipe is laid should be thoroughly compacted to the specified density. Many countries have their own standards for bedding materials. In South Africa, reference should be made to SANS 1200 for bedding specifications.





### 3.10.4 PIPE LAYING

For pipes that can be placed by hand, at no time should they be rolled and dropped into a trench as this will damage the pipes. For socket/spigot pipes they should be laid with sockets facing uphill or alternatively the sockets facing the direction of the flow to minimize ingress of water and other contamination. For deeper trenches or heavier pipes, tripods or cranes can be used to lay the pipes.

The minimum cover to pipes recommended is as follows:

**Table 3-14: Recommended Minimum Cover to UPVC Pipe**

Position	Area	Depth of Cover
Roads	Below road ways	1.2 m
Pavements	Below walkways	0.9 m
Private roads	Below roadways	0.6 m
Private land	Below walkways	0.3 m

Source: Petzakis PVC Manual

If minimum cover cannot be attained the pipe should be adequately protected normally by employing a concrete raft.

The pipeline must be laid directly on the constructed bedding in the trench and any temporary supports, bricks or other foreign hard bodies must be removed. All spigots must be checked to ensure that they are free from burrs. Both the spigot and socket surfaces must be carefully cleaned with a dry cloth prior to the application of the gel lubricant.

Every reasonable precaution shall be taken to prevent the entry of foreign matter and water into pipes. At the close of each day's work or at any time when the work is suspended for a significant period, the laid section of each pipe shall be plugged, capped or otherwise tightly closed until laying is recommenced<sup>6</sup>.

Rubber rings are usually used in jointing UPVC pipes to maintain watertight joints. It is important to ensure that the rubber ring is clean and free of stones and grit. It is however not necessary to remove the rubber ring as this has been fitted in the factory and held firmly in position. Check the chamfer on the spigot end - a uniform chamfer to approximately 15° must occur around the external circumference of the pipe for approximately half the wall thickness.

**Figure 3-10: Joining a Socket and Spigot**

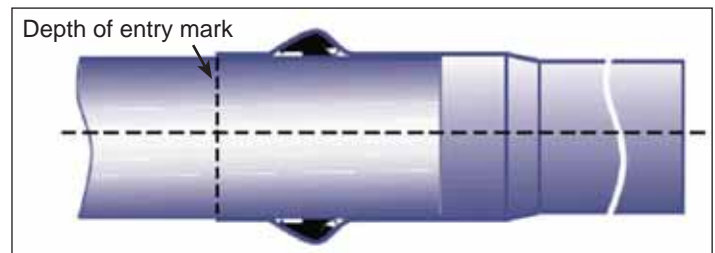

Source: SAPPMA

The depth of entry is marked on the spigot end which must be so positioned as to be just visible outside the mouth of the socket. See Figure 3-10 above.

### 3.10.5 BACKFILLING AND COMPACTION

It involves the covering pipes with soil materials (usually *insitu* excavated soil) to specified thickness. It is essential that PVC pressure pipes are backfilled immediately after each pipe is installed, in order to contain the expansion and contraction that may occur in an open trench. Immediate backfilling restricts expansion and contraction to each individual pipe length where it is catered for by the integral socket.

<sup>6</sup> SANS 1200 Section L.

### Side-filling and Initial Back-filling

Check that the depth of entry mark is just visible on all joints. Selected material (as for bedding) should be placed gently and evenly in un-compacted layers of 100mm in thickness between the sides of the trench and the pipe, as shown in the illustration below.

Tamp each layer firmly with a hand tamper until the level of the crown of the pipe is reached, taking care to ensure that no voids are left under the pipe. All joints must be left exposed at this stage. Movement of the pipe should be prevented by the simultaneous filling and even compaction of material on either side of the pipe.

Selected material should be placed in even and un-compacted layers of 100mm in thickness over the entire width of the trench to a height of 300mm above the crown of the pipe. All layers must be firmly tamped by hand. All joints are still exposed at this stage.

### Main Backfill

The remainder of the trench, excluding the areas where joints must still remain exposed, should be filled in layers of 300mm thickness and excavated trench material can be used. Each layer must be firmly tamped, the first layer by hand and subsequent layers by mechanical means if so desired.

For very dry soils, adequate water may have to be added to the soil to ensure effective compaction. See Figure 3-11.

Figure 3-11: Pipe Bedding and Backfilling

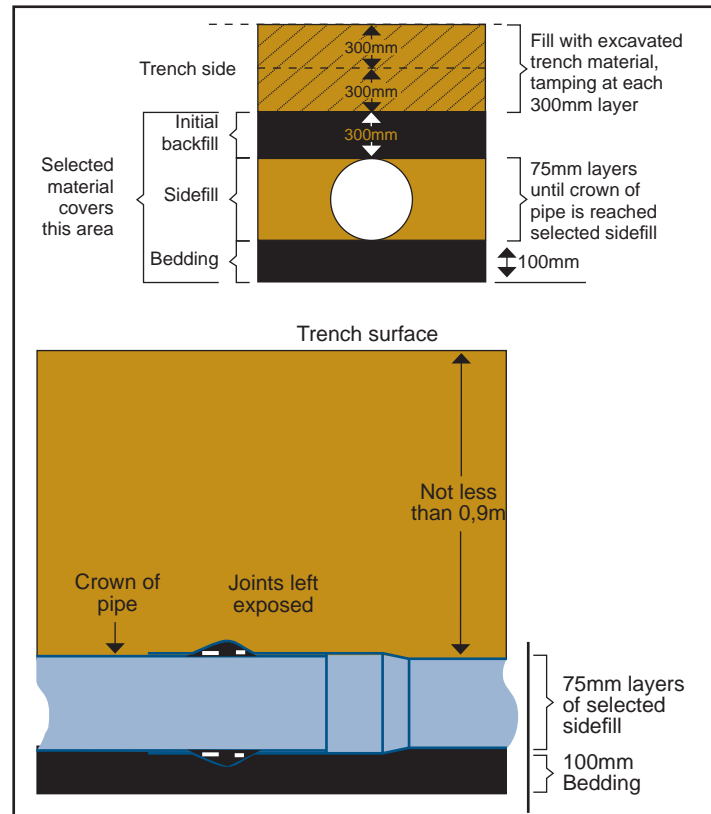

Source: SAPPMA

### 3.10.6 PIPE ANCHORING

When an internal hydrostatic pressure is applied to the pipe, unbalanced forces develop at all changes of size and direction in a pipeline. Thrust blocks prevent the movement of fittings and must be placed at all changes of direction, valves, stop ends and reducers. Concrete thrust blocks are most commonly used at all anchor points. The dimensions of the thrust blocks must be calculated to suit the pipe diameter, pressure and the load bearing capacity of the soil.

### 3.10.7 PRESSURE TESTING PROCEDURE

UPVC pressure pipe testing should be conducted in accordance with Pipe Manufacturer's<sup>7</sup> instructions as follows:

- Pressure test as short a length of pipeline as possible. (Between isolation valves or not more than 400 metre pipe section).
- Ensure that all air release valves are working properly.
- Open filling valve very slowly and only about 10% of capacity to ensure gradual filling.
- Allow pipeline to fill and pressurise to working pressure only.
- Allow approximately 2 hours for pipeline to settle under pressure.
- Pressurise as necessary back to working pressure as air escaping out of the water will show a reduction of pressure.

<sup>7</sup>Petzakis PVC Manual



- Once satisfied that no leaks have occurred, increase pressure gradually until test pressure of 1.5 (one and a half) times working pressure has been achieved.

Maintain test pressure for 1 hour only. (Do not pressure pipeline to 1.5 times more than once as this will reduce the life span of the pipe.)

- When installing tees such as scour and hydrant tees it is important that the leg of the tee is blanked off then pressure tested to allow pipe movement to take place.
- Once the pressure test has been completed, the necessary thrust blocks must be installed.

## 4. SANITATION

Poor environmental conditions arising from unhygienic disposal of excreta, sillage and accumulation of solid wastes contribute to the spread of diseases.

Sanitation refers to measures and interventions to prevent the occurrence of these diseases by keeping hygienic standards, thereby improving the health of the community.

The main transmission route of diseases through contamination of water and food which is commonly referred to as faecal-oral contamination is as illustrated in Figure 4-1 below.

**Figure 4-1: Transmission Route of Diseases**

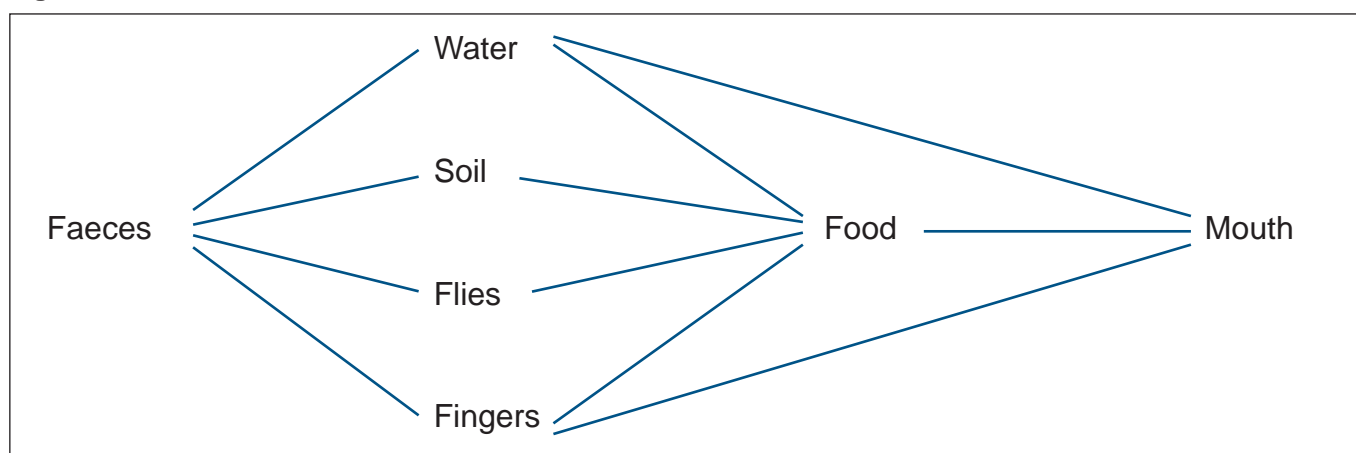

Source: WaterAID

If pathogens from human faeces enter a person's mouth and are swallowed, they will cause diarrhoea. If proper treatment is not given, this can prove fatal, particularly to children. The pathogens can enter the mouth in a number of ways including:

- Directly from a person's hands or fingers if:
  - o hands are not washed after a person has defecated, or
  - o hands come into contact with someone else's faeces on the ground (such as when small children are crawling or playing on the ground or when adults clear up a child's faeces)
- Indirectly from a person's hands, if not washed after defecation:
  - o from food which has been prepared by them or eaten with dirty hands
  - o from cups, other utensils or contaminated objects, handled by dirty hands

Contamination can also be through other intermediaries or vectors such as:

- Flies and other vectors: Food contaminated by flies or vectors which settle first on excreta, in a latrine or on the ground
- Drinking water: If it has been contaminated by faeces
- Soil: If this contains faeces, they can be transferred:
  - o through handling contaminated soils and not washing hands before eating, or
  - o by crops which are not cleaned and/or cooked properly before consumption

Sanitation is therefore the barrier to faecal-oral transmission of diseases. The main objective of improved sanitation is the replacement of casual or unsafe practices which allow faecal matter to be exposed to contact with flies/vermin, which may contaminate food, cooking and eating utensils, and drinking water sources. The Figure 4-2 below summarises strategies of good sanitation.



Figure 4-2: Sanitation Strategies

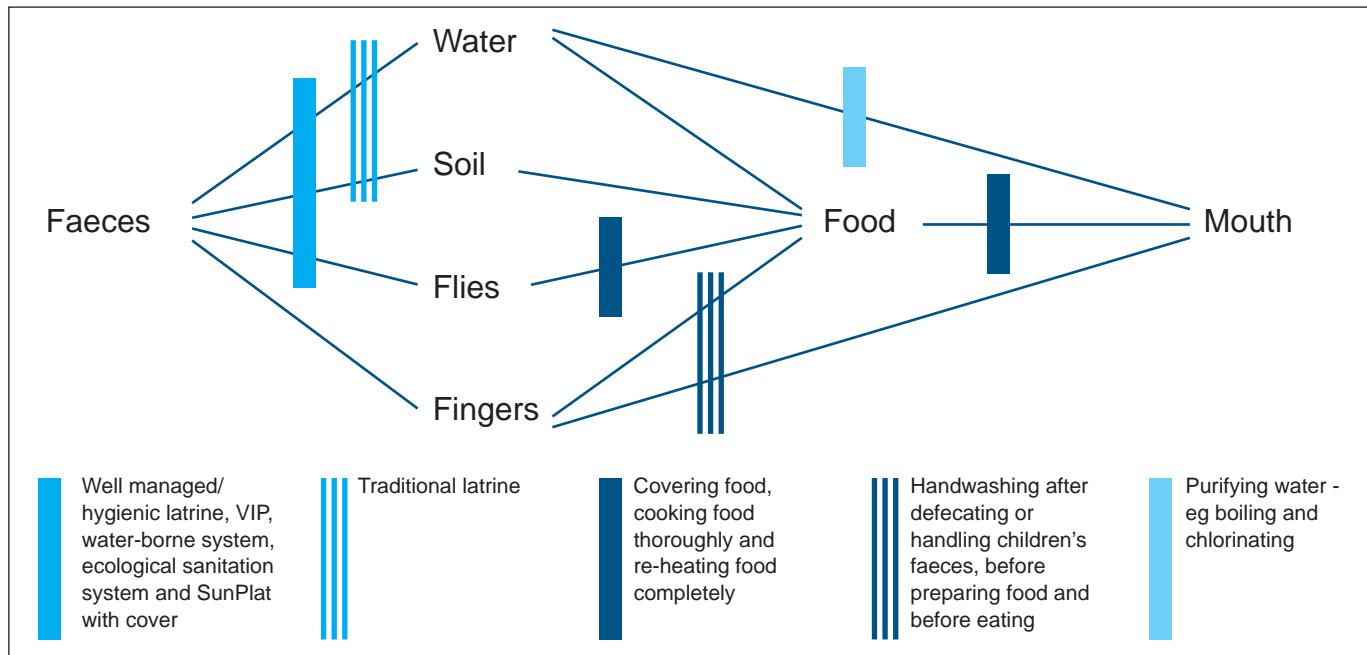

Source: WaterAID

## 4.1 PLANNING OF SANITATION SYSTEMS

The planning process for sanitation systems must be undertaken together with planning of the water systems and not in isolation as this leads to inefficiency and wastage of resources. Planners sometimes neglect sanitation planning till environmental problems surface. This leads to fast tracking of sanitation plans and implementation resulting in poor systems being developed.

Knowledge of the diseases endemic in a particular area is an important factor in the selection of water sources and sanitation provision. Planners have to be aware of the locally common diseases and ensure that the facilities they provide do not increase the incidence of endemic diseases but rather enables such diseases to be controlled. For example, stagnant water around wells may encourage malaria in certain areas if not properly drained.

Planning of adequate sanitation for a certain area and community is a delicate issue. Appropriate awareness creation for the respective population is essential and is the first step in the planning process. The causes and effects of endemic diseases have to be explained and the appropriate sanitation measures put in place.

The main aims of the Sanitation Policy are:

- to improve the health and quality of life of the whole population;
- to integrate the development of a community in the provision of sanitation;
- to protect the environment; and
- to place the responsibility for household sanitation provision with the family or household.

When planning sanitation system designers should be cognisant of the following:

- Basic services are a human right; although Government is obliged to provide the basic infrastructure, individuals are responsible for paying for their sanitation service;
- Development should be demand-driven and community-based;
- The economic value of water;
- Sanitation systems must be financially viable and users should ideally contribute towards the sustenance of the system;
- Sanitation provision must not take place in isolation from other services;
- The environment must be considered and protected in all development activities;
- Sanitation provision should include health and hygiene education.

The five main criteria to be considered when providing a sanitation system for a community are:

### Reliability

The adopted system should be durable over the selected design life. It should be easy to maintain resulting in minimal downtime during operation. As necessary it should be easy to upgrade to avoid obsolescence.

### Acceptability

The system should be accepted by the target group. The users should satisfy themselves that the system is easy to use and clean, is environmentally friendly and has the minimum aesthetic standard. Both male and females should be comfortable when using the system.

### Appropriateness

The system should suit the needs of the target groups. It should be environmentally friendly and at the same time it should not contradict socio-cultural norms and practices.

### Affordability

It is ideal that the system should be affordable to the target groups and should be easily developed using resources available at local level. For disadvantaged communities labour is usually abundant thus systems for such communities should as far as possible be employment intensive in their development and maintenance. As far as possible local materials such as stone, earth, grass and so forth should be used for this process.

### Sustainability

Community participation and ownership of a sanitation system is at the core of successful planning of implementation. The adopted should be easy to maintain and upgrade using local labour and skills. Community Monitoring and Evaluation structures should be established to ensure protection and sustainability of the assets.

The preferred planning approach involves stakeholder consultation in the planning, implementation and monitoring at all levels. This is commonly referred as the bottom-up planning approach. The other approach is the so called top-down approach whereby Technocrats take the lead in the delivery of sanitation services. The two approaches are described in Table 4-1 below.

**Table 4-1: Steps towards successful partnerships**



Source: DFID



## 4.2 SANITATION SYSTEMS

Sanitation systems can broadly be categorized into two groups namely Off-site and On-site systems. Basically wastewater can be conveyed from the source and treated elsewhere at a central point normally a sewage treatment facility. This type is referred to as the Off-site sanitation system whilst in the On-Site system the waste is treated on site before disposal. Sanitation systems can be categorised based on other criteria such as use of water or conveyance options. For instance in South Africa sanitation systems are categorized as shown in Table 4-2 below.

Table 4-2: Categories of Sanitation Systems

	Requiring Conveyance (treatment at central works)	No Conveyance Required (treatment, or partial treatment, on site)
No Water Added	<p>Group 1</p> <ul style="list-style-type: none"> <li>• Chemical toilet.</li> </ul>	<p>Group 2</p> <ul style="list-style-type: none"> <li>• Ventilated improved pit toilet.</li> <li>• Ventilated improved double-pit toilet.</li> <li>• Ventilated vault toilet.</li> <li>• Continuous composting toilet.</li> </ul>
Water Added	<p>Group 3</p> <ul style="list-style-type: none"> <li>• Full waterborne sanitation.</li> <li>• Flushing toilet with conservancy tank.</li> <li>• Settled sewage system.</li> </ul>	<p>Group 4</p> <ul style="list-style-type: none"> <li>• Flushing toilet with septic tank and subsurface soil absorption field.</li> <li>• Low-flow on-site sanitation systems (LOFLOS): <ul style="list-style-type: none"> <li>o Aqua-privy toilet.</li> <li>o Pour-flush toilet.</li> <li>o Low-flush system.</li> <li>o Low-flow septic tank.</li> </ul> </li> </ul>

Source: CSIR

The selection of the most appropriate sanitation system is influenced by technical, cultural, institutional and economic factors. For informal low-income settlements, the on-site system is frequently adopted due mainly to economic considerations. However, some informal settlements are sited on areas with high water table, or on rocky, or clayey materials where some on site systems such as septic tanks may not perform to satisfaction. It is thus important that a thorough feasibility study be undertaken before implementation even for informal settlements.

The off-site system is usually much more expensive to construct and to maintain. Maintenance has to be organised centrally for the entire system.

The following are some of the available sanitation options.

### 4.3 ON SITE SANITATION OPTIONS

#### 4.3.1 UNIMPROVED PIT TOILET

The system consists of a top-structure around and/or over a pit, generally unlined where soil conditions allow, with a pedestal or squat-plate. This system is not recommended because of its associated bad odours and insect infestation. See Figure 4-3.

#### 4.3.2 CHEMICAL TOILET

This comprises of a watertight tank containing suitable doses of detergents which are used to disinfect urine and excreta. This system is not recommended because it has both high initial and maintenance costs. It is however useful for events such as fairs, flea markets, music shows, construction sites and other functions.

#### 4.3.3 BUCKET TOILET

Typically it consists of a top-structure with the seat positioned above a bucket or other container located in a small compartment beneath. The bucket should periodically be emptied at designated disposal points. This system is not recommended because it is unhygienic and environmentally undesirable.

Figure 4-3: Variants of an Unimproved Pit Latrine

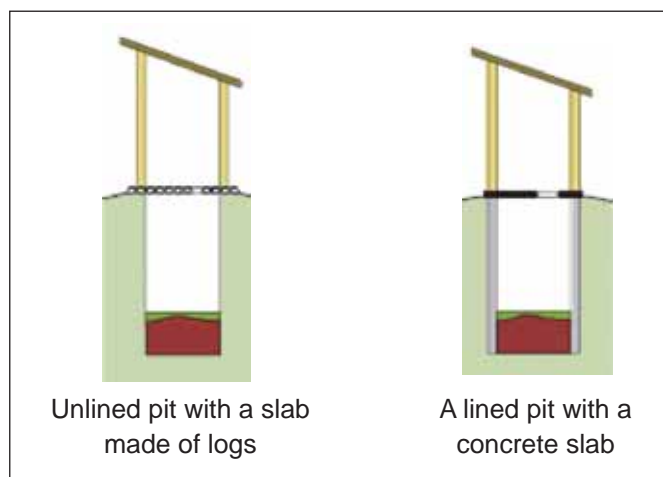

Source: DFID

#### 4.3.4 VENTILATED IMPROVED PIT LATRINES (VIPS)

Figure 4-4: Ventilated Improved Pit Latrine

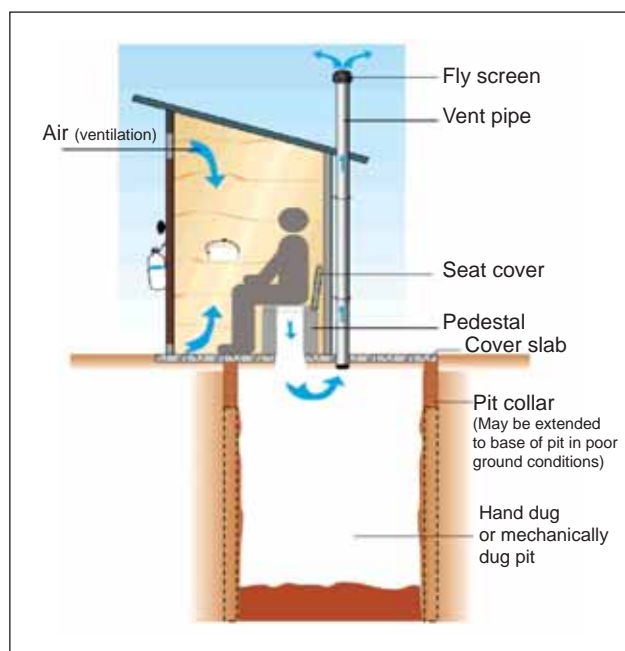

Source: DWA

The VIP is a pit latrine which is ventilated by means of a vertical pipe. The action of wind blowing over the top of the vent pipe creates an up-draught of air, which flows up the pipe. Air is drawn down through the hole in the cover slab and circulates in the pipe. Any unpleasant odour passes up the pipe rather than out of the hole in the cover slab into the superstructure. Flies are attracted to the top of the vent pipe, but the presence of a fly screen made out of fine gauge mesh prevents most flies from entering. Flies which breed in the pit tend to head towards light, but the screen blocks their exit. The interior of the latrine superstructure needs to be darkened to prevent flies from entering, which requires the latrine to have a permanent superstructure with a roof. A separate hand washing facility is required to encourage good hygiene practice. See Figure 4-4.





### 4.3.5 VENTILATED IMPROVED DOUBLE PIT (VIDP) LATRINES

Figure 4-5: Ventilated Improved Double Pit Latrine

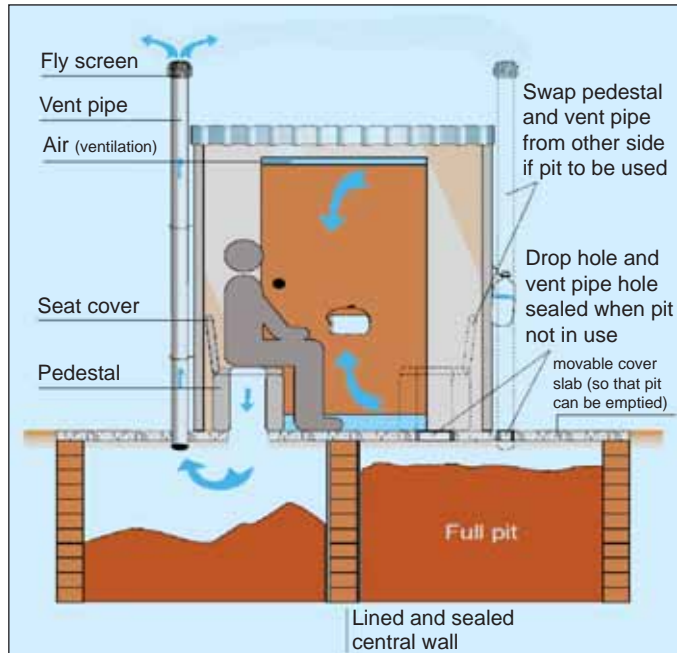

Source: DWA

The VIDP is ventilated pit latrine with a double pit. Areas of high housing density have potentially high densities of pit latrines associated space constraints especially in urban areas. Problems encountered with ground conditions, high water table and groundwater pollution usually leads to the pit being very shallow. Unfortunately this means that the pit fills rapidly and rapid emptying is required. These difficulties can be overcome by using the double pit latrine system in which both pits are shallow, but not less than 1.2 metres deep. Additional capacity can be obtained by increasing the plan areas or raising the pit at additional costs.

The first pit is used until it is full, and the second pit is then put in use. When the second pit is full, the first can be emptied safely because the contents will have been digesting for at least one year. See Figure 4-5.

### 4.3.6 CONTINUOUS COMPOSTING (CC) TOILETS

Figure 4-6: Continuous Compost Toilet

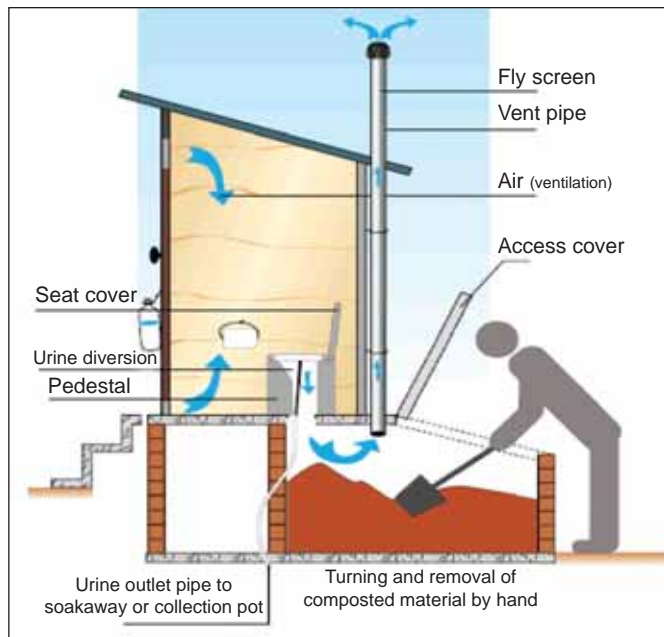

Source: DWA

This is a ventilated pit latrines with a provision to separate solid and liquid waste. Continuous composting toilets make use of air to enable aerobic bacteria to break excreta down to fertilising material. The excreta are contained in a vault below the pedestal and liquid input must be kept to a minimum by separating urine and faeces. Vegetable and/or other organic matter is added in the right quantity periodically and compost must be removed at the optimal rate. See Figure 4-6.

### 4.3.7 POUR FLUSH PIT LATRINES

Figure 4-7: Pour Flush Latrine

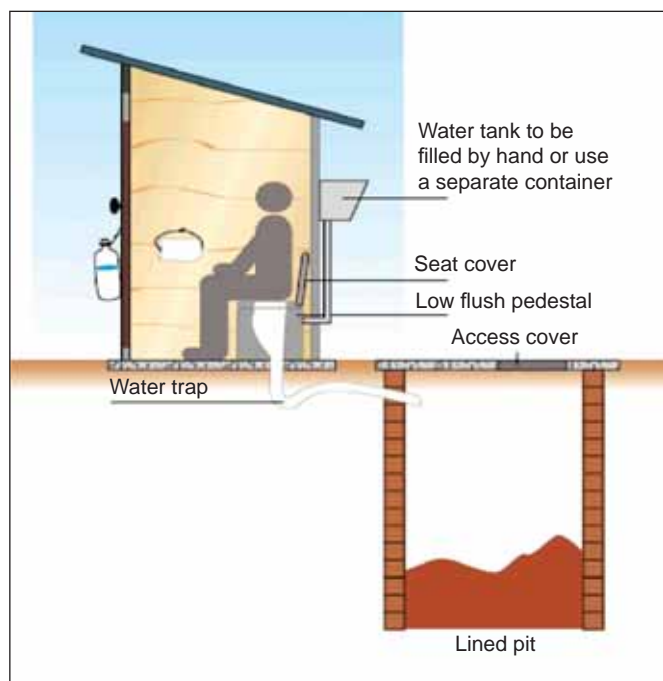

Source: DWA

Where water is abundant and where local practices dictate this, pour flush toilets may be opted for. This is a normal toilet complete with water seal that discharges into a separately constructed pit which isolates the pit from the superstructure. When filled with water, the u-shaped trap forms an effective seal, thus eliminating smell and fly nuisance. The trap is designed so that it requires only a small volume of water to flush excreta into the pit. Depending upon the detailed design, 1 to 6 litres of water are required for each flush, which is much less than the 10 to 20 litres for conventional cistern flush toilets.

### 4.3.8 AQUA-PRIVY TOILETS

Figure 4-8: Aqua-privy Latrine

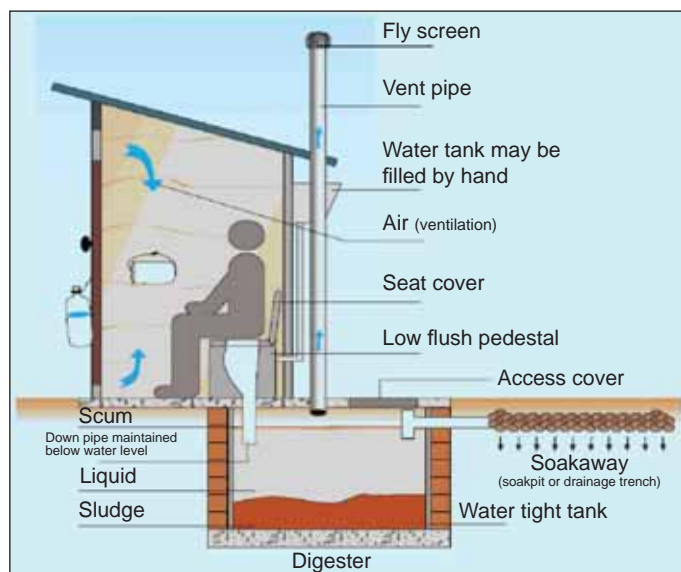

Source: DWA

An aqua-privy consists of a latrine constructed above, or adjacent to, a watertight tank which receives liquid effluent. The excreta drop into the tank through a vertical pipe. This pipe should extend at least 75mm into the liquid so that a water seal is formed. In order to maintain the water seal, the fluid level in the tank must be maintained and this requires a bucketful of water each day to compensate for water losses. The overflow pipe should be connected to a soakaway or small diameter sewer. Since this type of latrine has a very low water usage the volume of effluent discharging from the tank is small but very concentrated. The tank needs to be periodically desludged and so a removable cover for the tank must be provided.

The cost of constructing an aqua-privy is higher than building a raised or step latrine and it needs to be well designed and maintained to ensure that it has an adequate design life. There is also a risk that the tank may provide a breeding ground for mosquitoes unless it is perfectly sealed from the external environment. See Figure 4-8 above.



### 4.3.9 SEPTIC TANKS

A septic tank comprises a sealed tank that has both an inlet and an outlet into which excreta are flushed from a conventional cistern flush toilet using typically between 10 to 20 litres of water for each flush. The tank is connected to the toilet by a sewer pipe. Partially treated effluent flows out of the tank into a soakaway or waterborne sewer. This marks an important difference from the pit latrine, in which any water entering the pit leaves by percolation into the surrounding ground. Septic tanks may receive either toilet waste alone, or both toilet wastes and sullage from sinks, showers and baths.

The septic tank acts as a settlement unit in which solids settle out by gravity; the solids undergo a process of anaerobic decomposition. The settled sludge has to be periodically removed by a suction tanker from the septic tank.

The effluent which flows out of the septic tank constitutes a potential health hazard. A common disposal method is by absorption into the ground using a soakage pit or trench known as a soakaway. The soakaway consists of a trench filled with suitable aggregate covered with an impervious material and backfilled with in-situ material. Seepage from the tank is usually through the sides of the trench since solids normally clog the bottom of the trench. An open jointed pipe normally distributes the effluent into the soakaway. The soakaway system can be either a single trench or a series of trenches.

**Figure 4-9: Septic Tank**

Septic tanks may be built to combine several households or plots. Regular maintenance (removal of sludge) is essential and this renders maintenance of septic tanks to be relatively expensive. See Figure 4-9 above.

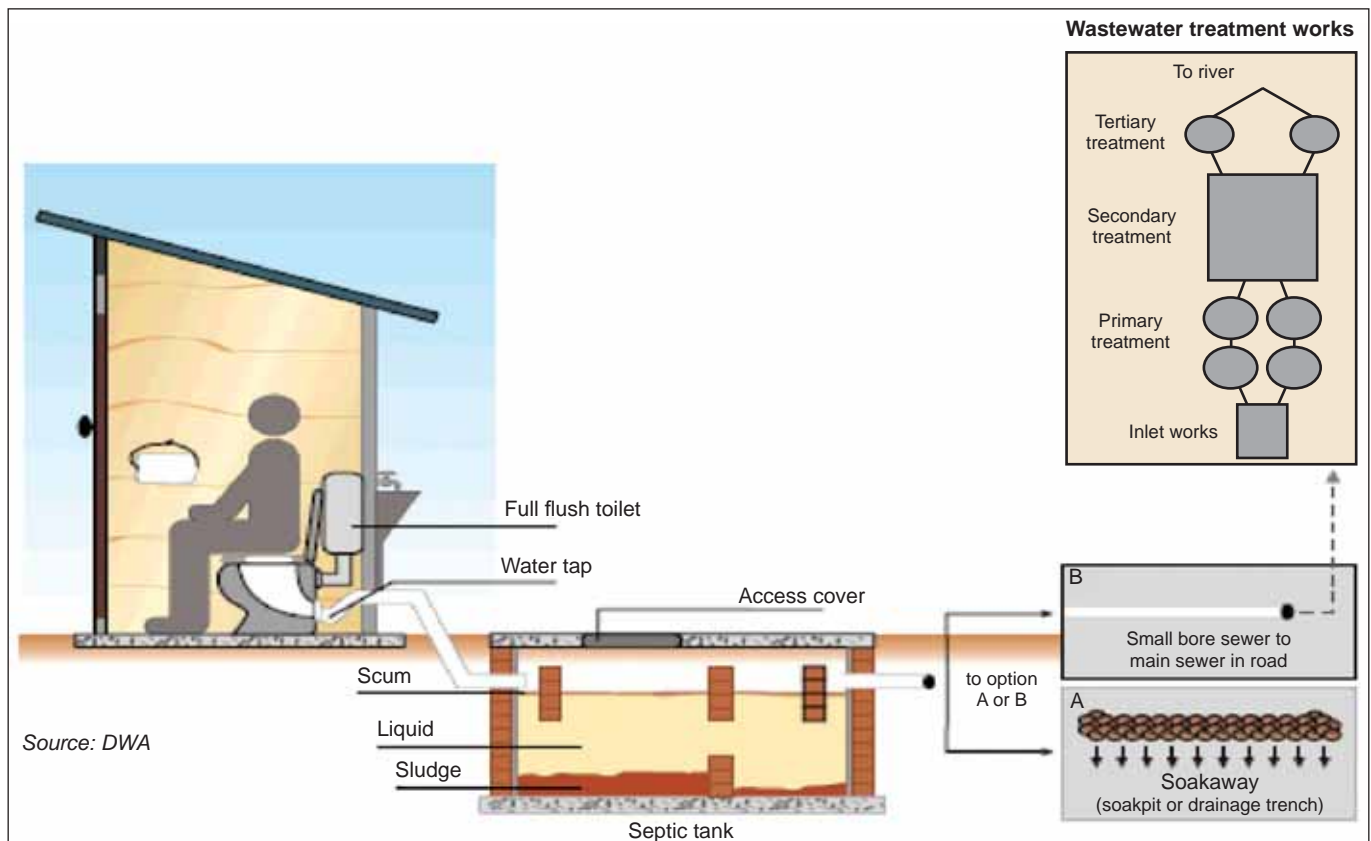

Septic Tanks are normally designed to have a detention period of 24 hours. Some conservative designers recommend that since the septic tank normally retains solids and floating scum the detention time should allow for the volume taken up by the scum and solids. If one assumes that scum takes up one-third of the

effective volume and the settled solids also take up a third of the volume, the effective volume of the tank is one third of the total volume. Therefore the design detention time of the tank should be taken as 72 hours. Other design considerations are as follows:

- The first compartment should be two-thirds of the total volume and the second compartment will be one-third of the total capacity.
- Length to breadth ratio is normally 2 -3 to 1.
- Effective liquid depth is normally 1 to 2 metres.
- Sludge on average builds up at 0.003 to 0.004 m<sup>3</sup>/cap./year.
- Inlet, outlet and compartmental baffles should be allowed for to discourage scum and sludge to be carried over to the soakaway.

### Water Closet

The Septic Tank is normally used with a conventional water closet (WC) also known as a full flush toilet. The WC is commonly used in both urban and rural areas and consists of a water closet and a flush tank connected to a water supply system. The water closet is also used in conjunction with conservancy tanks or a conventional sewer system. Modern toilets incorporate an ‘S’ or ‘P’ shaped bend that allow the water in the toilet bowl to collect and act as a seal against gases in the sewer, septic or conservancy tanks. See Figure 4-10 below.

Figure 4-10: Commonly used Water Closets



Source: Wikipedia

### 4.3.10 CONSERVANCY TANK

A conservancy Tank is a water tight tank that receives wastewater from a community. It has no outlet or overflow and has to be emptied periodically. It is normally employed as a temporary measure to an off site waterborne wastewater treatment system. Waste is flushed into the tank where it is contained in isolation from the surrounding environment before removal by tanker for treatment. Tank sizing is dependent on flush volumes, domestic wastewater levels and frequency of emptying. Access for mechanical emptying is provided. It should be provided where there is availability of treatment and disposal facilities within a reasonable distance.



## 4.4 OFF-SITE SANITATION OPTIONS

### 4.4.1 CONVENTIONAL SEWER SYSTEM

A full bore waterborne sewerage system consists of a series of underground pipes collecting and transporting excreta and household sullage to a point of discharge normally a wastewater treatment plant. The appurtenances and fittings required include: sewer pipes, household connections, grease traps, interceptor tanks, and manhole chambers.

### 4.4.2 SIMPLIFIED SEWER SYSTEM

There are supporters of this system as it advocates for simplifying sewerage to suit the resources of the target communities. The approach is to reduce the minimum size of the collect sewers to 100mm and reduce the minimum gradient to 1 : 220 at the same time reducing the number of inspection and manhole chambers. Reduction of manholes is achieved by increasing their spacing. This can reduce capital costs by about 25%. Although this approach has been used in Brazil and elsewhere in Southern Africa it is important to consider the following issues before its adoption.

- Some communities use sand as scourer to clean pots and eating utensils and this normally finds its way into sewers;
- Local diets include dense maize meal which also finds its way into the sewers;
- Water shortages may cause sewers to block at such flat gradients;
- This system should be considered for use with interceptor fixtures such as aqua privies and septic tanks.

### 4.4.3 CONDOMINIAL SEWERS

Condominial sewerage, which has been used extensively in Brazil, involves the laying of collector sewers at the rear of properties close to the point of waste generation. This unconventional layout reduces the length and depth (hence earthworks) of house connection sewers and also minimizes the amount of pumping required although the total length of main sewers can be longer. The maintenance of condominial sewers is the responsibility of the community. The total cost of condominial sewerage is about half the cost of a conventional system, and it may be cheaper than on-site systems at high population densities. This should be considered in informal settlements and developments where there is no potential for owners to improve their dwellings. However, this option tends to waste space and poses other challenges during maintenance and upgrading. See Figure 4-11 below.

Figure 4-11: Condominial sewer layout in Petrolina, Brazil

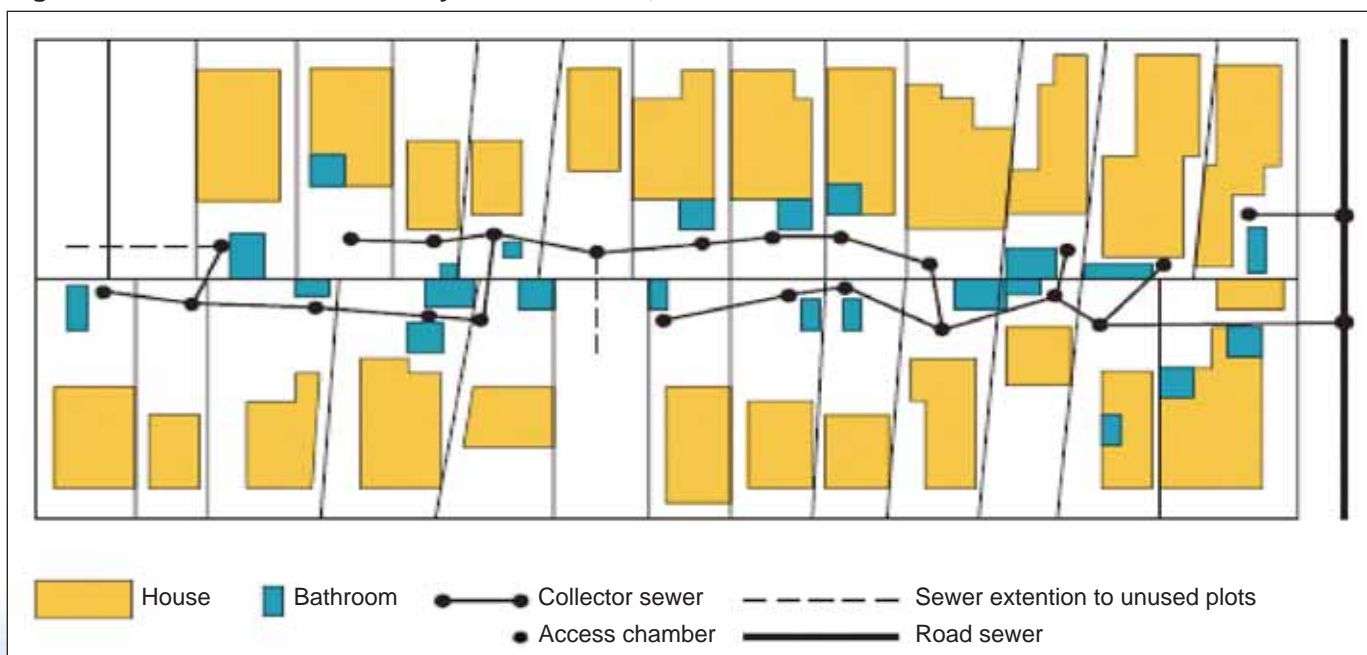

Source: D. Mara

#### 4.4.4 COMMUNAL TOILETS

Most of the above sanitation options, whether waterborne or on site, can be used communally in residential areas which are commonly referred to as communal toilets. In this system central toilet facilities are provided for more than one household. This system is not ideal for residential use as it is unhygienic and does not afford privacy and dignity. To maintain communal toilets in a clean and hygienic condition is generally difficult as it is difficult to inculcate a sense of ownership in communities for such public facilities. The safety of the vulnerable groups and in particular women, young girls and boys during night use is not necessarily guaranteed.

Some of the systems mentioned above are not preferred in some countries due to various technological, economic as well as constitutional reasons. For instance in South Africa unimproved VIP Latrines, Bucket toilets and communal toilets are not preferred and efforts are being made to replace them in compliance the provisions of Water Services Act of 1997. See Box 4-1 below.

#### Box 4-1: Extract from South African Sanitation Regulations

The minimum standard for basic sanitation services is -

- a) the provision of appropriate health and hygiene education; and
- b) a toilet which is safe, reliable, environmentally sound, easy to keep clean, provides privacy and protection against the weather, well ventilated, keeps smells to a minimum and prevents the entry and exit of flies and other disease-carrying pests.

### 4.5 TECHNICAL DESIGN CONSIDERATIONS FOR VIP LATRINES

This section is focusing on VIP Latrines that are commonly used in rural areas, informal settlements and generally in low income communities. The general considerations in the design of VIP latrines are:

- Life cycle cost
- Safety
- Comfort
- Privacy
- Health

Specifically the following must be considered in the design, construction and maintenance of VIP latrines.

#### 4.5.1 GROUND CONDITIONS

Thorough field investigations/surveys and planning need to be undertaken before construction of these assets. Ground conditions are particularly important for the success or failure of on site systems. Aspects to consider should include:

- Bearing capacity of the soil (for the design of the superstructure)
- Soil stability
- Depth of intermediate and or rock
- Infiltration Rate. (Refer to the Table below for recommended rates).
- Fluctuations of groundwater table
- Ground Pollution Risk

For instance, raised pits and shallow Ventilated Improved Double Pit (VIDP) Latrines may be considered in difficult areas where:

- The water table is close to the surface;
- The groundwater sources are likely to be contaminated easily;
- There is hard rock close to the surface;
- The geology is such that pits are susceptible to collapse before design depth is achieved; and
- The area is prone to flooding.

As a rule the base of the pit should be at least 1.5m above the rainy season water table. Typical infiltration rates are given in Table 4-3 below.

**Table 4-3: Soil Infiltration Rates**

Soil Type	Description	Infiltration Rate Litres/m <sup>2</sup> .day (mm/day)	
		Clean Water	Wastewater
Gravel, coarse and medium sand	Moist soil will not stick together	1,500 - 2,400	50
Fine and loamy sand	Moist soil sticks together but will not form a ball	720 -1,500	33
Sandy loam* and loam	Moist soil forms a ball but still feels gritty when rubbed between finger	480 - 720	24
Loam, porous silt loam	Moist soil forms ball which easily deforms and feels smooth between fingers	240 - 480	18
Silty clay loam and clay loam	Moist soil forms a strong ball which smears when rubbed but does not go shiny	120 - 240	8
Clay	Moist soil moulds like plasticine (modeling art clay) and feels very sticky when wetter	24 - 10	Unsuitable for VIPs

\*Loam soil composed of sand, silt, clay, and organic matter in evenly mixed particles of various sizes

Source: Reed et al

#### 4.5.2 SITING OF LATRINES

The VIP latrines should be so sited in order to minimize environmental impact, address the key design factors stated above, and other socio-cultural considerations. Latrines should be so located:

- Not more than 50m away from the dwellings served;
- At least 30m away from water storage and treatment facilities;
- At least 30m away from surface water sources;
- At least 30m from shallow ground water sources. This distance should be increased in coarse, fissured or sandy formations;
- Downhill of settlements and water sources;
- At least 50m away from food storage or food preparation areas;
- Close to hand washing facilities;
- As to be easily accessible to the old, children, pregnant women and people with disabilities; and
- In secure location especially for night use by the vulnerable.

#### 4.6 CONSTRUCTION OF HOUSEHOLD VIP LATRINES

The Construction of VIP latrine which involves the following operations and activities can be undertaken by Employment Intensive Method as a means of maximizing job creation. It is therefore highly recommended that this method be adopted provided site and ground conditions permit. Indicative task rates for related earthworks are given in Chapter 7 of this document. In addition Table 4-4 provides labour requirements in the construction of a household VIP latrine.

**Table 4-4: Labour Requirements for Constructing a Household VIP Latrine**

Activity	Unskilled Labour (Worker Days)	Semi-skilled Labour (Worker Days)
Excavation of Pit	Refer to Table	
Lining of Pit	1.00	1.00
Casting of Concrete Slab	0.25	0.25
Superstructure brickwork	0.50	0.50
Erection of Roof and Door	0.50	0.50
Install Vent, pedestal and finishes	0.25	0.25
<b>Sub Total</b>	<b>2.50</b>	<b>2.50</b>
Contingency	0.25	0.25
<b>Total Labour</b>	<b>2.75</b>	<b>2.75</b>

Source: Sanitation Job Creation: A Guideline for Municipalities (DWAF et al)

The lining and superstructure can be constructed in Blocks, Bricks or traditional materials. The Materials required for a brick or block VIP latrine are given in Table 4-5 below.

**Table 4-5: Materials for Household VIP Toilet**

Description	VIP in Blocks	VIP in Bricks
Pit Lining	80 Blocks	300 Bricks
Superstructure	100 Blocks	350 Bricks
Door and Frame		1
Roof		1
Pedestal in blocks or concrete		1

Source: Sanitation Job Creation: A Guideline for Municipalities (DWAF et al)

Prefabricated elements are also used in construction of VIP latrines. However, to create employment on such projects, use of blocks and bricks or other locally available materials should be considered on preference to mass produced prefabricated elements.

If the Blocks or bricks are manufactured on site the worker days for the construction can be generally be doubled. A detailed work method for the construction of a VIP Latrine is given in See Box 4-2 below.

**Box 4-2: Construction of VIP Latrine**

**Excavation**

- Identify the soil conditions. For sandy or stony soils the pit has to be lined).
- Set out the edge lines for excavation using the profile boards. If lining is required add the thickness of the pit walls to the excavation width. Typical pit diameters are:
  - o unlined pit in stable ground = 100cm
  - o lined pit in soft ground = 140cm
- Excavate step by step. The excavated material has to be hauled to the top with buckets. A tripod or a simple winch is useful to haul the material safely from deep pits.
- Ensure that the internal dimensions and form of the pit is uniform from top to bottom. Shape pit walls.
- Deposit the excavated material safely away from the pit (at least 5 metre distance) downhill.
- Haul the excavated material to an approved dump place or use for other construction work if required.





**Pit Lining**

**1. Foundation:**

- At the bottom of the pit set out the trenches for the foundation and excavate.
- Cast the foundation with concrete or build with bricks/ blocks.
- Add a layer of hardcore to the pit bottom.

**2. Lining with bricks or cement blocks:**

- Construct walls using bricks or cement blocks.
- Do not fill the vertical joints with mortar so that liquid from the pit can seep into the surrounding soil. Ensure good bonding. Ensure alignment is truly vertical.
- For circular pits use a template (semi- circle) to check the shape.
- After every course backfill the walls with sand or gravel.
- Fill all vertical and horizontal joints for the top 50cm.

Note: In soft ground conditions or where the soil is not stable the pit has to be lined. The thickness of the walls has to be considered for the excavation.

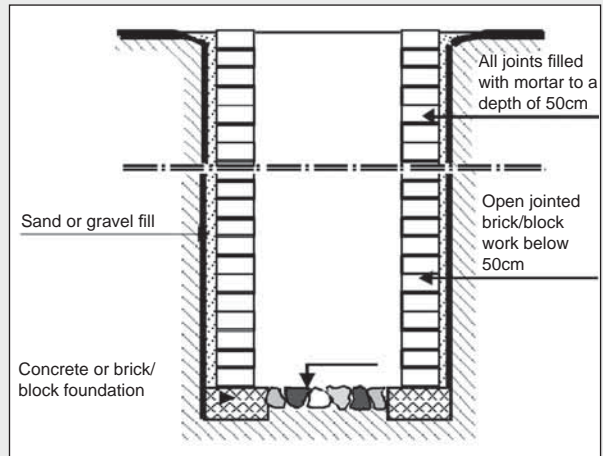
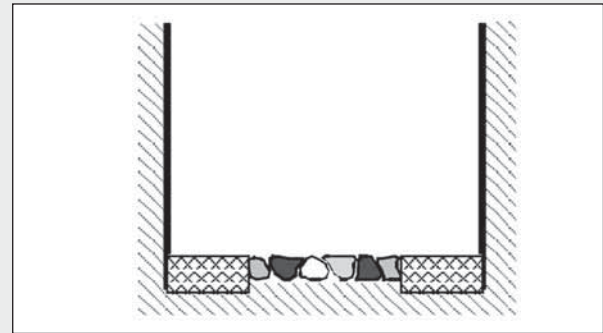

**Reinforced Concrete Pit Slab**

The Slab should be able to support the full weight of an adult, be easy to clean and slope slightly towards the squat hole. The squat hole should be “keyhole” shaped with a diameter of 160 to 180 mm and a length of 250 to 320 mm.

**Slab Construction**

- Prepare a flat and horizontal platform;
- Spread Builders paper over flat surface;
- Construct a timber shuttering;
- Place the reinforcement and spacers;
- Place wooden forms for squat and ventilation pipe holes;
- Cast concrete and trowel top. Ensure slope towards the squat hole;
- Slabs of mass greater 320kg are not recommended to be moved by hand.

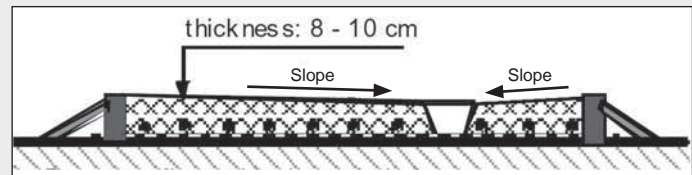

The slab in Grade 25/19 concrete should be constructed as per the Table.

Slab Thickness (mm)	High Yield Steel Reinforcement bar (mm)	Spacing of steel bars (mm) in each direction for minimum spans of				
		1.00m	1.25m	1.50m	1.75m	2.00m
65	6	150	150	125	75	50
65	8	250	250	200	150	125
80	6	150	150	150	125	75
80	8	250	250	250	200	150

Source: WEDC

### Un-reinforced Concrete Slab

The slab is dome shaped and cheaper. It is usually 1.2 to 1.5m in diameter and 40 to 50mm thick.

Slab Casting	General Arrangements
<p><b>1 Shaping the sand</b></p>	<p style="text-align: center;"><b>Construction Aids</b></p> <div style="display: flex; justify-content: space-between;"> <div style="width: 45%;"> <p><b>Round bar</b></p> </div> <div style="width: 45%;"> <p><b>Slab former</b> S: nail for shaping the sand C: nail for shaping the concrete</p> </div> </div> <div style="display: flex; justify-content: space-between; margin-top: 10px;"> <div style="width: 45%;"> <p><b>Pipe spacer</b> 25mm ID</p> </div> <div style="width: 45%;"> <p><b>Wooden form for squat hole</b></p> </div> </div> <div style="display: flex; justify-content: space-between; margin-top: 10px;"> <div style="width: 45%;"> <p><b>Shuttering</b></p> </div> <div style="width: 45%;"> <p><b>Bolt here</b></p> </div> </div> <div style="margin-top: 20px;"> <p><b>Squat hole</b></p> </div>
<p><b>2 Casting the concrete</b></p>	
<p><b>3 Casting multiple slabs</b></p>	



### Construction of the Superstructure

Build walls with bricks or cement blocks along the edge of the slab (can be used as foundation).

Leave openings near the top in all 4 walls for ventilation and light.

Install timber/metal frame and door.

Plaster inside of cubicle walls with cement mortar and trowel smooth (for easy cleaning). In case you need to economise, plaster only 1 metre from the bottom.

Point the joints outside and above the plastered section.

Fix ventilation pipe with fly screen on top. Seal with suitable sealant around the pipe on the roof and with cement on the floor slab.

Provide a cover for the squat hole (can be made from timber). Alternatively install a suitable seat.

Paint walls and door.

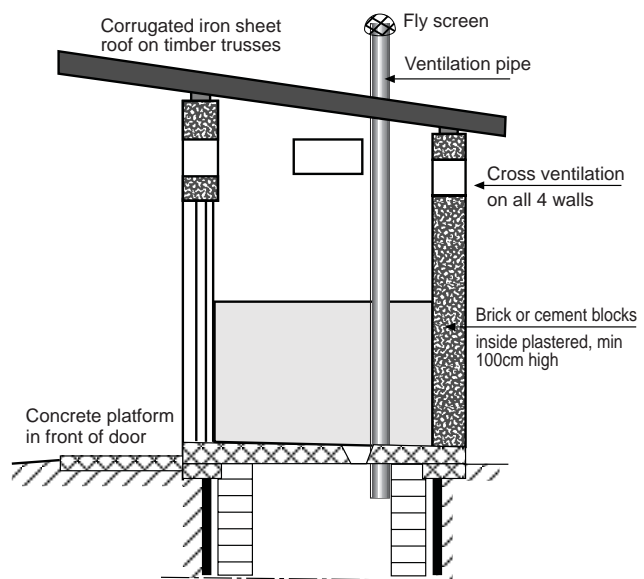

Source: ILO

## 4.7 CONSTRUCTION OF SEPTIC TANK AND SOAKAWAY

There are many methods to construct a Septic Tank. In general a skilled Bricklayer assisted by unskilled workers is able to construct the Tank. Box 4-3 below illustrates one of the methods of constructing a Septic Tank and Soakaway.

### Box 4-3: Constructing a Septic Tank and Soakaway

#### Septic Tank Construction

- Assemble all materials, tools, workers, and drawings needed to begin construction. Study all drawings carefully.
- Clear the site, set out as per drawings, and excavate the required earthworks to formation and foundation levels.
- Use the profile boards with wires and plumb bob to establish the 4 corners of the septic tank.
- Establish the bottom level of the slab; use reference point from profile board.
- Place hardcore layer of approximately 150 to 200 mm, compact to specification.
- Add lean blinding concrete layer of approximately 50mm thickness to establish a level working surface.
- Cast bottom slab (add crack reinforcement as specified), trowel slab top smooth.
- Construct lower concrete dividing wall; ensure that the wall can be tied into outside walls.
- Construct outside walls. Leave grooves for the 2 baffles and dividing wall. Plaster walls inside if not made of concrete.
- Construct the formwork for the 2 reinforced concrete baffles and the dividing wall and cast concrete.
- Construct formwork for the top slab. Add reinforcement and spacers. Provide openings (manholes) for access, minimum  $\varnothing$  600mm.

- Cast concrete, trowel top smooth and cure for 28 days. Remove the formwork from the slab and baffles.

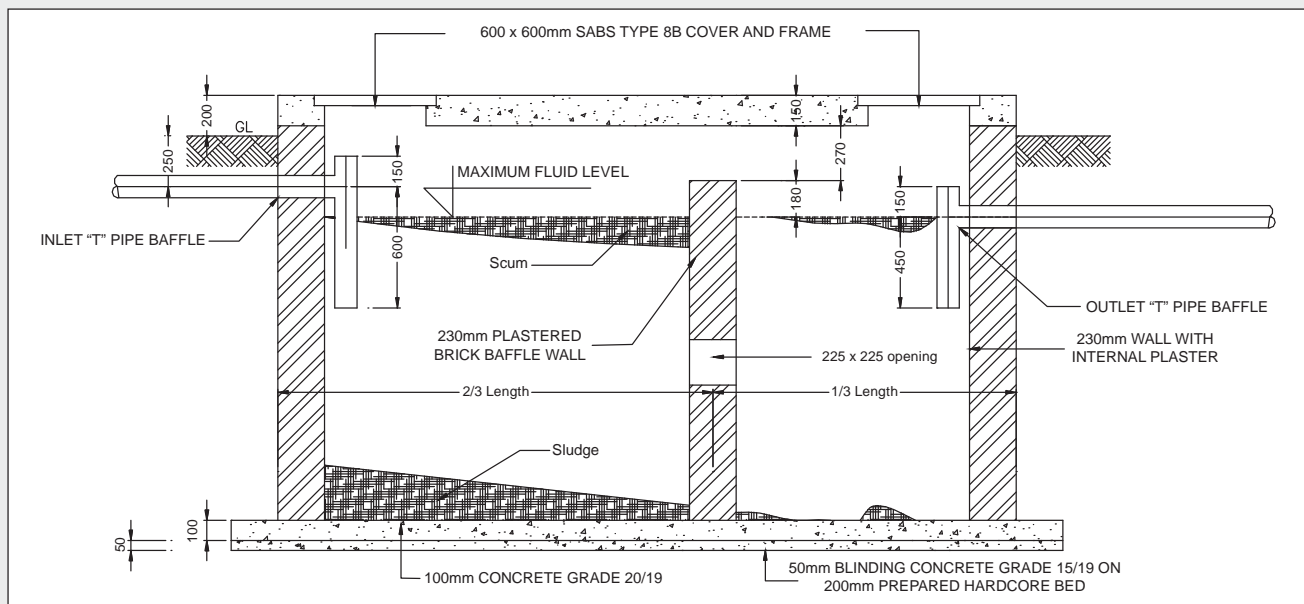

### Soakaway Construction

- Assemble all materials, tools, workers, and drawings needed to begin construction. Study all drawings carefully.
- Use the site plan and a measuring tape to determine the correct location for the soakaway, including distribution box or “cross” or “T” fitting as necessary, and mark it on the ground with wooden stakes or pointed sticks. Mark the trench line for the sewer pipe from the septic tank to the site of the soakaway. Get written approval from the Project Engineer before commencement of construction.
- Excavate the trench from the septic tank to the site of the soakaway. The trench should slope evenly and should be as straight as possible. Avoid sharp bends. The trench need not be more than 600mm wide and should have a minimum depth of 600mm, sloping downward to the soakaway. In level or uneven ground, the trench may have to be deeper to attain the correct downward slope of 1 in 100.
- The end of the sewer pipe must be at least 600mm underground when it enters the soakaway. This is to ensure that the absorption system is deep enough to have sufficient cover.
- Lay sewer pipe in the trench. Seal all pipe joints as per the pipe manufacturer’s specification.
- Double check the slope of the pipe to be certain that liquid will flow downward from the septic tank to the absorption system.
- Cover the sewer pipe to the required specification and allow for final settlement by overfilling of the trench as instructed by the Engineer or Supervisor.
- Excavate the soakaway trench to the length, width, and depth specified. The bottom of the absorption trench should be nearly level or slope gradually and evenly downward from the inlet end (septic tank end) at no more than 1 in 200.
- Lightly rake the bottom and sides of the trench with a rake or hoe. Do not walk in the trench after this step or the bottom will become compacted and lose permeability.
- Spread 150mm of clean gravel or crushed rock along the entire length of the trench. The depth of the gravel must be uniform so the grade will remain gradual and even.
- Lay the first section of drainpipe in the inlet end of the absorption trench and fix it to the end of the sewer pipe.
- Lay the remainder of the drainpipe in the trench. If slotted pipe is used, the perforations must face downward. If open-jointed pipe is used, do not seal the joints. Leave a space of 12 to 25 mm between each pipe section. If non-perforated plastic pipe is available, either (a) drill 12mm holes 150mm apart in two parallel rows along the bottom of the pipe and use as perforated pipe, or (b) saw the pipe into 450mm long sections and use as open-joint pipe. The drainpipe must be level or slope downward away from inlet end at no more than 1 in 200.

- Plug the end of the last pipe section with cement, mortar, or other material that will not corrode.
- Cover the open joint between pipe sections with building or tar paper to prevent cover gravel from sifting and clogging the system.
- Fill the trench with gravel or crushed rock to a depth of 75mm above the top of the drainpipe. Place the material gently to avoid damage to the pipe
- Cover the gravel or crushed rock with untreated paper, straw, hay, grass or other impervious material as specified to prevent dirt from sifting into the gravel.
- Fill the trench with soil and mound it to allow for settling. Do not compact.
- Plant grass over the system when the mound has settled, after a week or two. This will help prevent erosion by wind, rain, or surface water.

**Typical Section through Soakaway (in mm)**

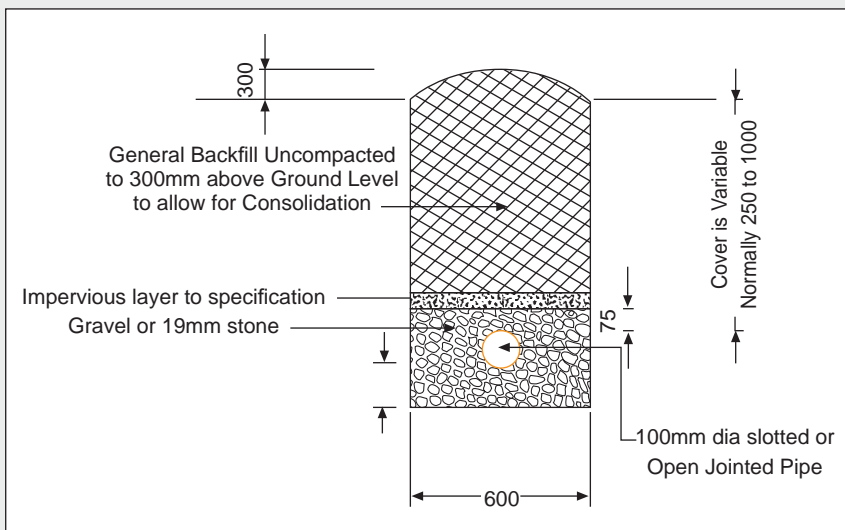

## 4.8 SEWER CONSTRUCTION

Sewers can be designed in a variety of ways with the ultimate objective that they achieve self-cleansing velocity at least once a day. Box 4-4 below gives a typical conventional sewer design criteria used in Southern Africa. See Appendix 1 for uPVC pipe sizes, dimensions and masses.

### Box 4-4: Typical Sewer Design Criteria

The design criteria for the sewers is as follows:

- Design life > 20 years
- Minimum size: 150 mm Nominal  $\varnothing$
- Material: uPVC, AC, Concrete, GRP, HDPE.
- Minimum Gradients : 1:diameter of pipe
- Minimum velocity at Peak flow: > 0.6 m/s

Manholes Spacing		Manholes Sizes	
Pipe Size in mm	Manhole Spacing in Metres (maximum)	Depth Range in m	Manhole Diameter mm in
160	60	$\leq 2.0$	1000
200 - 315	75	2.1 - 3.0	1250
315 - 500	100	3.1 - 4.0	1500
515 - 600	50	> 4.0	1800

Sewer pipes, like water pipes, can be flexible or rigid. The factors to consider with regards to pipe laying for water and sewer pipes are largely similar. For gravity sewer systems control of levels is very crucial aspect of the workmanship for pipe laying. Box 4-5 below illustrates a typical situation for sewer pipe construction.

**Box 4-5: Sewer Construction**

Construction of a sewer system begins at the lowest point. This is the point at which the system empties into a trunk or outfall sewer or into a wastewater treatment facility.

Sewer systems are generally constructed in sections, in order to avoid leaving survey stakes/pegs exposed and trenches open for a number of days. A section of sewer line is staked out, the trench is dug, pipe is laid, tested and the trench is backfilled. Then the adjoining section is staked, the trench is dug, and so on. The following steps are recommended:

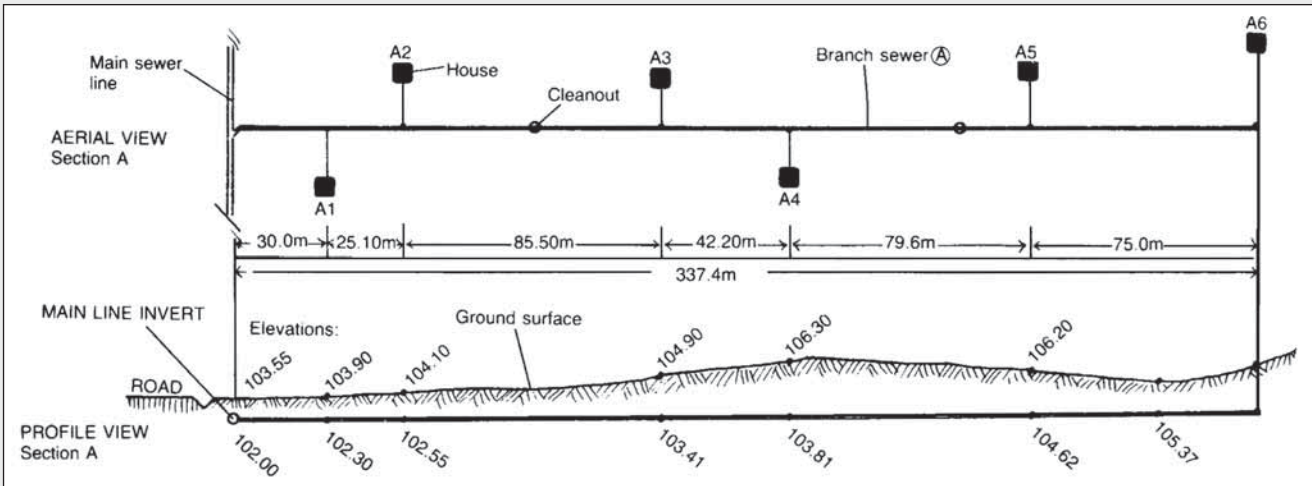

- Mobilise workers, materials, and tools. Because of the size of the project, workers are often assembled in gangs with gang leaders and each gang is assigned a specific task: one gang excavates trenches, one lays pipe, and so on. For smaller works individuals may be assigned specific tasks throughout the project.
- Stake pipe lines and grade. Begin at the outfall end of the sewer system and work “upstream” (towards the inlet). Stake out only that portion of the pipeline that can be constructed in a few days. This will avoid ponding in case of rain or if groundwater is encountered.
- It is important that the gradient is accurately staked out using suitable levelling instruments.
- First, stake the centre line of the pipe, setting a stake every 5 metres. Set a pair of grade stakes for each centre line stake. The grade stakes in each pair should be at the same elevation, should be equidistant from the centre stake, and should be at right angles to the centre line of the pipe. The grade stakes should be set far enough from the centre line stake so as not to be disturbed during excavation of the trench.
- Commence excavating the trench with the width as

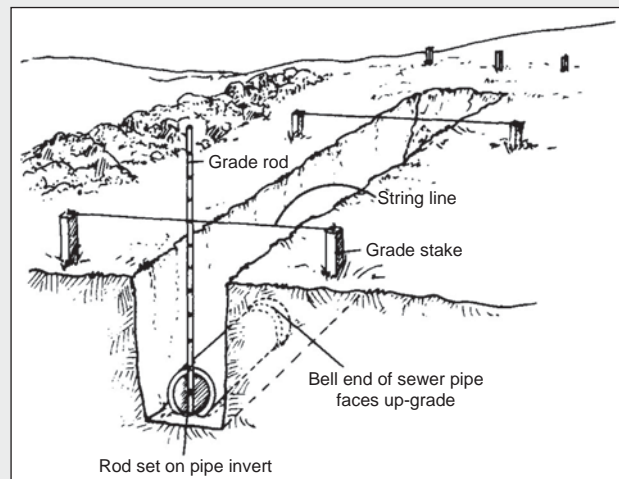
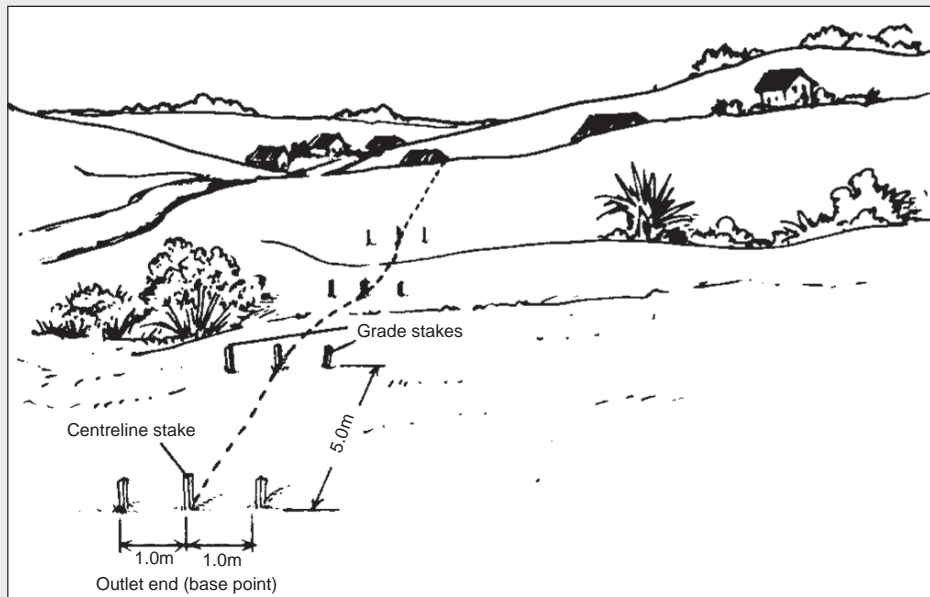



specified. Check the line and elevation of the trench bottom with a grade rod and a string stretched between a pair of grade stakes as shown in the Figure below. If the bottom of the trench is rocky or soft, excavate about 100mm below the invert grade and fill with gravel. Note that if hard rock is encountered it may be necessary if feasible to divert the line or to use mechanical equipment or explosives to remove it.

- Support the sides of trenches deeper than 1.5m with formwork and braces. Install a section of sheeting and braces for each addition 1.0m of trench depth. The collapse of a trench wall not only slows the progress but can injure or kill workers.
- Position the first section of pipe with the bell-end upstream. Make a small excavation at the bell-end so that the entire length of pipe is supported by soil. Position the second section- and seal the joint with a rubber gasket to Manufacturer's specification.
- Joints must be watertight. Only a section between two plugged manholes or a section appropriately plugged at each end shall be tested at a time to the appropriate specification. Water or Air Tests are acceptable for this purpose.
- At the end of each work day, plug the ends of the sewer pipe to prevent entry by rodents or snakes.

Construct inspection chambers, manholes, or rodding ways at the intersections of branch lines and the main sewer line.

Remove all bracings if necessary and backfill.

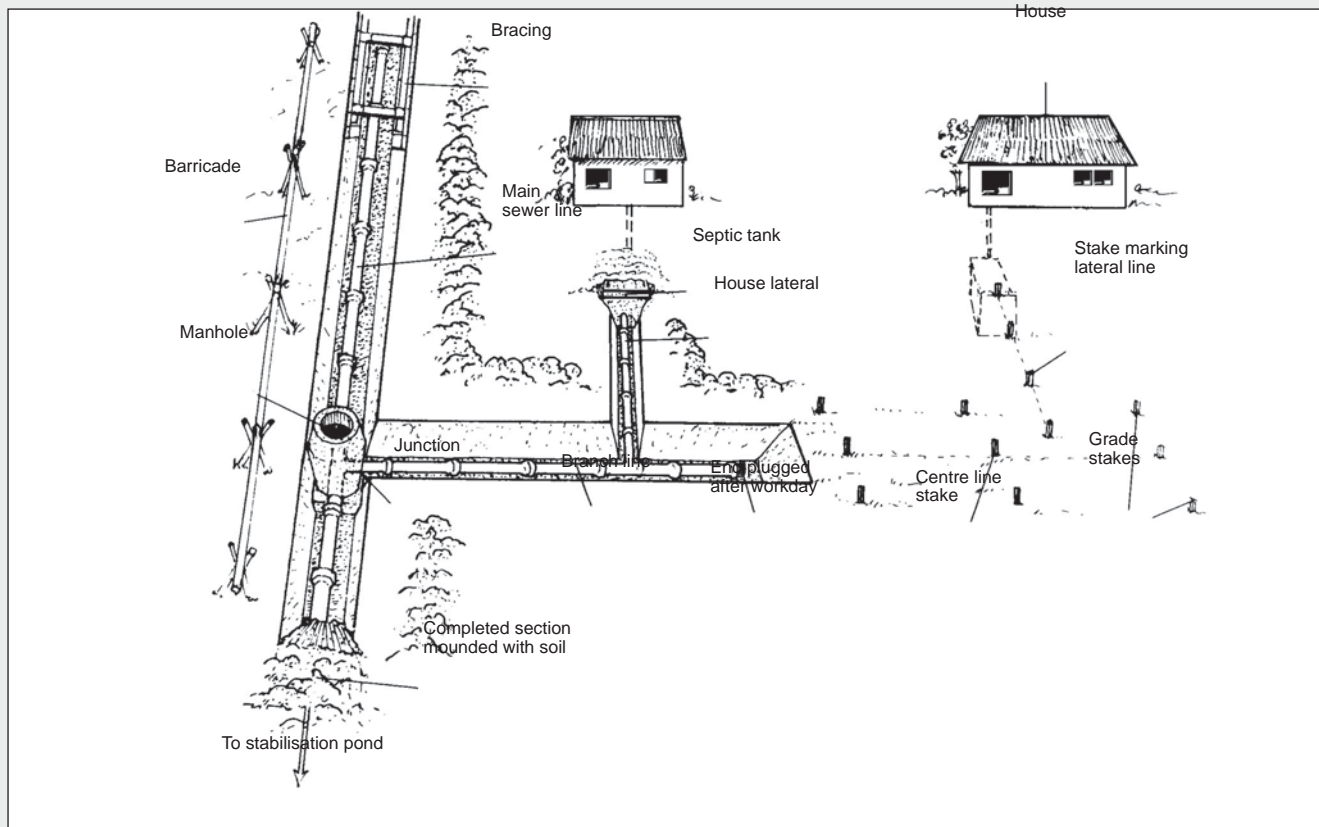
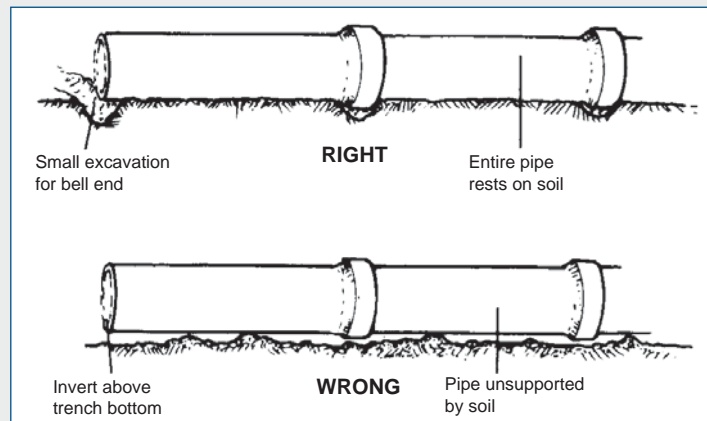
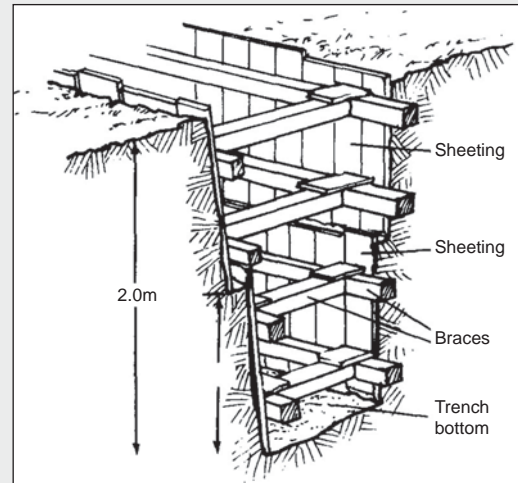

**Rodding Way**

Rodding ways are provided for maintenance purposes at the head of a sewer (or top end) or in shallow sections where it is impractical to construct a manhole.

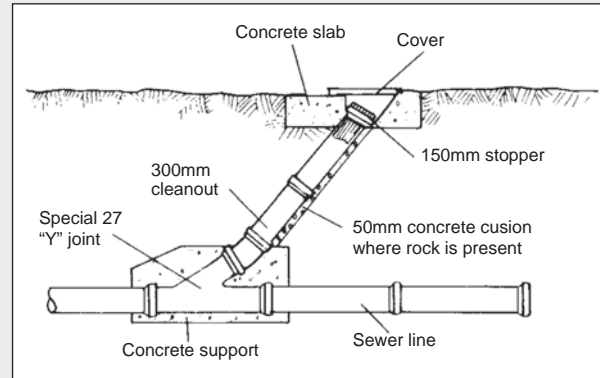

**Precast Manhole Construction<sup>8</sup>**

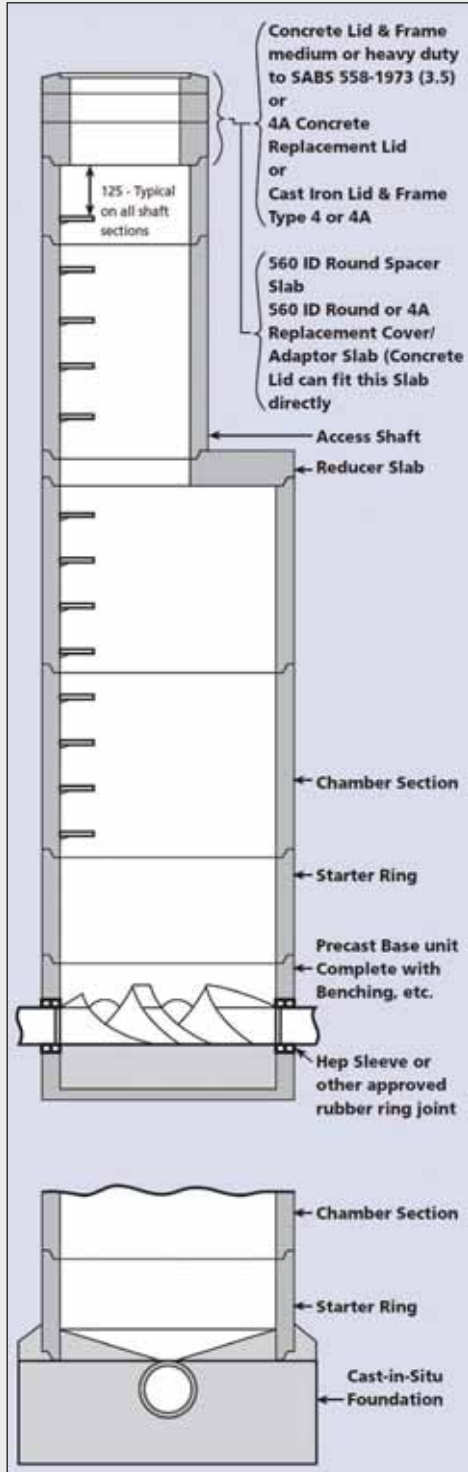

Complete Manhole with access Shaft



Precast Manhole Base



Manhole Chamber and Shaft



<sup>8</sup>Rocla (Pty) Ltd : Rocla Manholes, Chambers, Shaft Sections & Slabs Brochure





### SEQUENCE OF OPERATIONS

- a) Excavate for installation of manholes to the required depth and dimensions.
- b) Place the bottom unit with either integral precast, or insitu concrete base.
- c) Erect the required number of standard components and seal the joints as appropriate all in accordance with the design.
- d) Place a reinforced concrete cover slab on top.
- e) If required place a corbel slab then add the appropriate number of adjusting units.
- f) Fit the manhole top for access from ground level.

### MANHOLE ASSEMBLY

To ensure that the manhole structure is vertical, accurate levelling of the formation or the in-situ concrete foundation is essential.

Shaft and chamber sections with tongued and grooved joints should be installed with the socket/groove facing upwards whereas units with ogee joints should have the spigot upwards.

Precast cover slabs can be laid directly onto the shaft or chamber rings. Manhole tops can then be bedded on the adjusting units to achieve the level required.

### Typical Manhole Joints

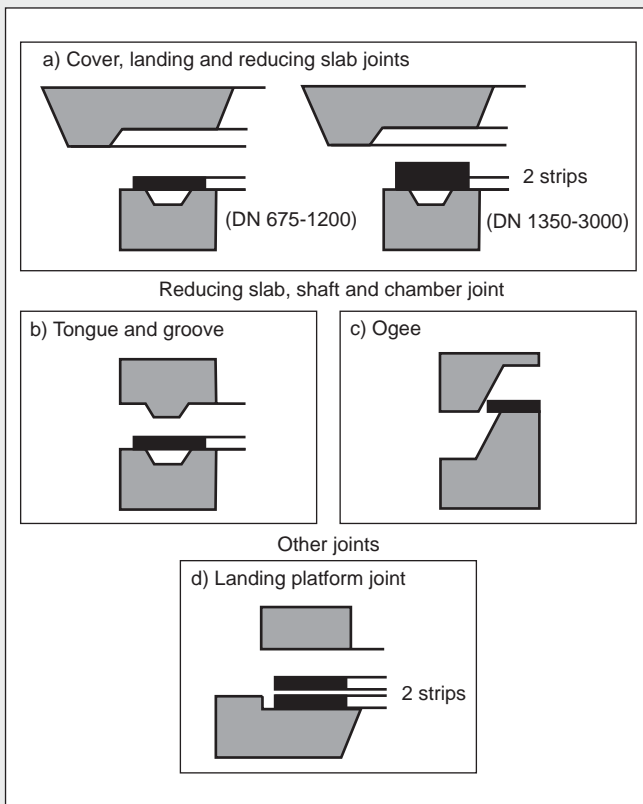

### Jointing to pipeline

To allow for any differential settlement between manhole and pipeline, short “butt” pipes, either spigot or socket, should be built into the manhole wall so that a flexible joint is incorporated as close as possible to the outside of the manhole or the concrete surround if used. Depending on ground conditions, short length pipes (rockers) then connect these butt pipes to the incoming pipe runs. Additional care must be taken to ensure that the joints are properly made.

### JOINTING

Precast manhole components are provided with joints formed within the wall section. These are rebated or tongued and grooved and are sealed with proprietary mastic seals, sand/cement mortar, or units fitted with rubber ring joints may be available. Precast concrete manhole units, well jointed, provide an adequate seal under normal conditions. Any lift holes will need to be sealed with a sand/cement mortar, or a proprietary non-shrink mortar.

### REINSTATEMENT

#### *In-situ concrete surround*

In-situ concrete surround to precast concrete manholes, except for side-entry manholes, is unnecessary other than for exceptional structural reasons such as embankments, or in sloping or unstable ground. Side entry manholes should be provided with 150mm thick surround of Grade 20 concrete extending the whole length of the pipe in which the manhole is placed.

**Backfilling**

As each precast manhole section is placed, backfill should be returned in layers and compacted as for pipelines. Backfill must be brought up evenly around the manhole to prevent displacement. Additionally care should be taken to avoid damaging the connecting pipelines.

**TESTING**

Normally about 10% of manholes are water tested. However, it is generally unnecessary to apply water tests to all the manholes since in normal working conditions, manholes are not usually full of wastewater. This only happens under rare conditions of surcharge. Prevention of infiltration is of more relevance than exfiltration, and where this occurs it can be detected by visual inspection and remedied by sealing using an appropriate method. The project specification may however require water testing of a certain percentage of manholes.

Source: Lifewater International, Rocla

Note that manholes can also be constructed insitu using concrete, bricks, blocks or stone masonry. This option has an added advantage of maximizing employment and is preferred in comparison with use of precast concrete units in situations where social objectives are a priority.

## 4.9 CONSTRUCTION OF STABILISATION PONDS

Stabilisation ponds are simplified wastewater treatment systems consisting of a series of ponds (excavated basins with sloped sides) linked by channels or pipes. A typical system will consist of anaerobic, facultative and maturation ponds in series. The effluent is normally not suitable for discharge into water bodies and usually disposed of by irrigation or used for groundwater recharge where this is environmentally feasible.

The major part of pond construction involves bulk earthworks. Larger ponds can be constructed by a combination of labour and equipment. Because of the bulk earthworks involved haulage of material is normally undertaken by equipment. It is however, recommended that stabilisation ponds with dimensions less than 100m x 300m be constructed by employment intensive methods.

Water Institute of Southern Africa (WISA) has developed a method of design for Waste Stabilisation ponds which is detailed in their Manual: Design of Small Sewage Works. D. Mara also developed several publications on Waste Stabilisation Ponds (WSP) including the Manual for WSP design for Eastern Africa which can also be referenced.

As a general guide the gross land requirements for Waste Stabilisation Ponds are 7 hectares per 1,000m<sup>3</sup>/day of wastewater treated.

### 4.9.1 LOCATION OF STABILISATION PONDS

Stabilisation Ponds should be located down-wind of the residential, commercial and other sensitive areas to limit odour nuisance. It is recommended that the works should be located at least half a kilometre away from these areas. They should also be located at least 2km away from an airport or other aviation facilities as birds attracted to the ponds may pose a threat to airplanes if sucked into jet engines. Pumping of wastewater may sometimes be necessary if these goals are to be realised.

Other factors to be considered in locating the ponds include:

- The site must ideally allow the collected wastewater to gravitate to the ponds and within the installation as it flows from process to process.



- Final effluent overflow from the ponds must naturally drain away from areas such as dams and residential areas.
- The site should not pose a threat to underground water.
- Sufficient land must be available for the ponds, effluent irrigation lots for final effluent disposal and any future expansion as necessary.
- The Soil type at the site should not be too rocky or highly permeable. If the available area is permeable measures must be taken to seal the ponds.
- Sufficient construction material for embankments must be available from the excavated materials or at least within a reasonable distance from the site.

Box 4-6 below gives a typical work method used in minor WSP construction.

#### Box 4-6: Method of Pond Construction

##### Preparing the Site

- Mobilise all labour, materials, and tools needed to begin construction.
- Locate the site and set it out the structures as per drawings.
- Clear the pond and embankment site of all trees, bushes, stumps, large rocks, and any other material not suitable for building the embankment. Haul this material to a designated disposal site.
- Remove any trees upwind from the site for a distance of 100 ~ 200 m with written approval of the Engineer. This will create an unobstructed wind path, which will improve the efficiency of the pond after it is put into operation.
- Remove topsoil from the site and place it at a designated area that will not obstruct construction. This will be used later to finish the embankment.

##### Staking Pond Site and Pipe Locations

- Set reference stakes 5 ~10 m apart indicating the boundaries of the bottom of the pond. Survey the elevation of each stake using a dumpy level.
- Measure the distance and elevation from the reference stakes, set slope stakes indicating the points at which to begin building the embankment and excavating the pond.
- Set stakes to indicate pipe locations. This will eliminate re-excavating portions of the embankment.

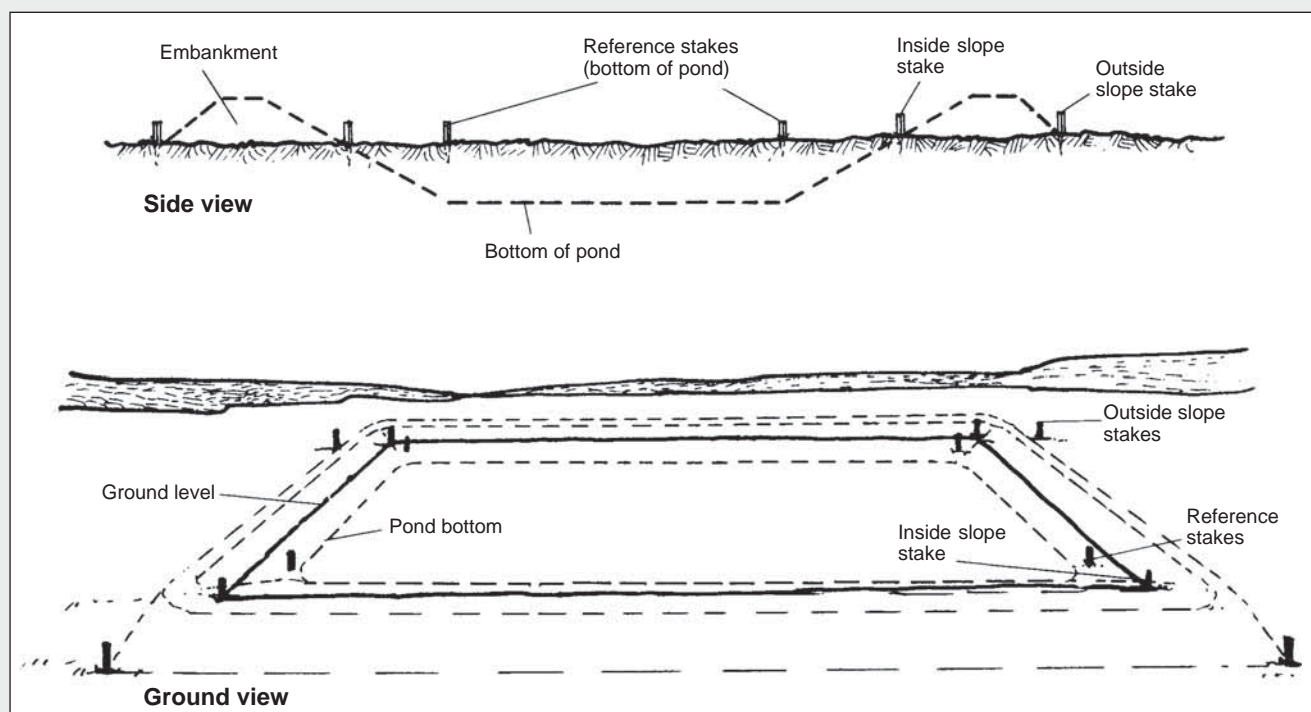

### Excavations

- Begin excavating at the inside slope stakes as shown in illustration above. Excavate at the slope specified by the project designer until the bottom elevation is reached. Check this elevation with a dumpy level and rod.
- Continue excavating along the bottom elevation of the pond. Use excavated soil to construct the embankments.
- The bottom of the pond should be level and as uniformly compacted. If there are soft spots or tree roots, dig them out, fill with moist soil and compact
- Make the corners of the pond rounded as per the drawings and specification.

### Embankment Construction

Begin constructing embankments as the pond is excavated. Embankments must be well tamped, with sides sloped according to design specifications.

Leave gaps in the embankment at pipe locations. It may also be convenient to leave one or more wide gaps for removal of excavated soil.

The top of the embankment must be level, well-tamped, and at least 1m wide.

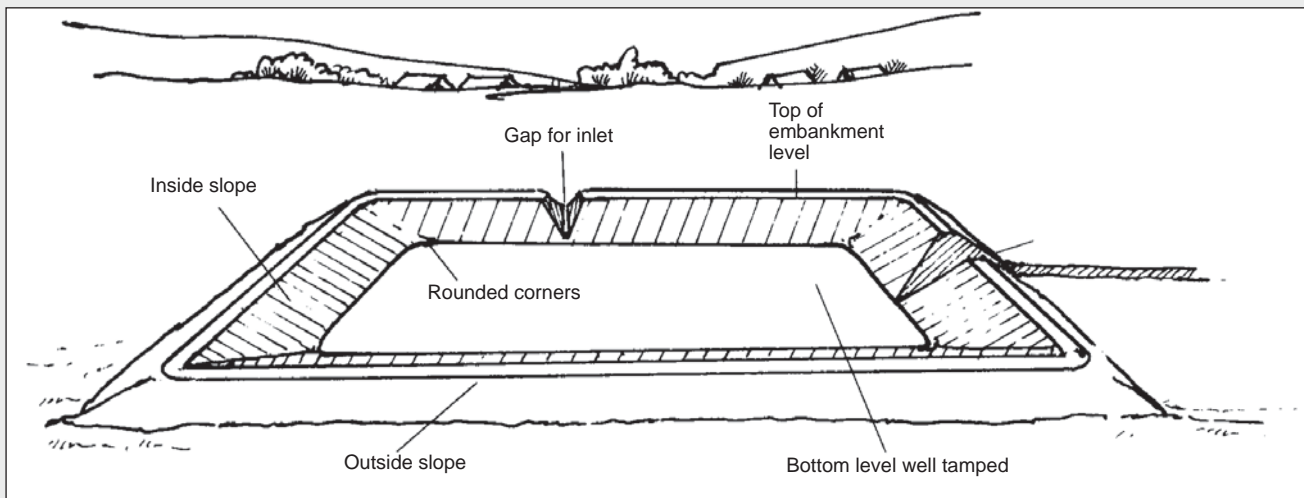
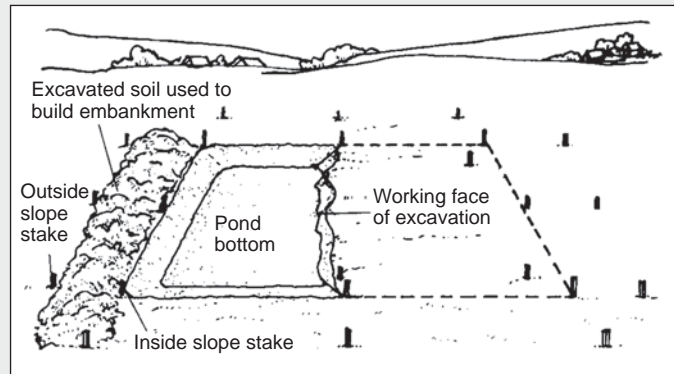

### Pipe Laying

Excavate trenches for pipes at the design depth and locations. The bottoms of the trenches should be well tamped.

- Build bases for the inlet pipes from concrete or stone. The purpose of the bases is to raise the inlet pipe above the bottom of the pond.
- Build slabs for the outlet pipes from concrete or stone. The purpose of the slab is to support the outlet pipe and to prevent erosion due to the discharge of treated sewage. Build support slabs under all valve locations.
- Lay sewer pipe to specification. Install valves as specified.
- Build the scum guard for the outlet and install outlet pipe. The scum guard should extend at least 300mm above and 300mm below the vertical outlet. It will prevent floating debris from entering the outlet pipe after the pond is put into operation. The height of the vertical outlet determines the depth of the pond. It must be equal to the design depth specified by the project Engineer.
- Carefully fill in pipe trenches with moist soil and tamp.

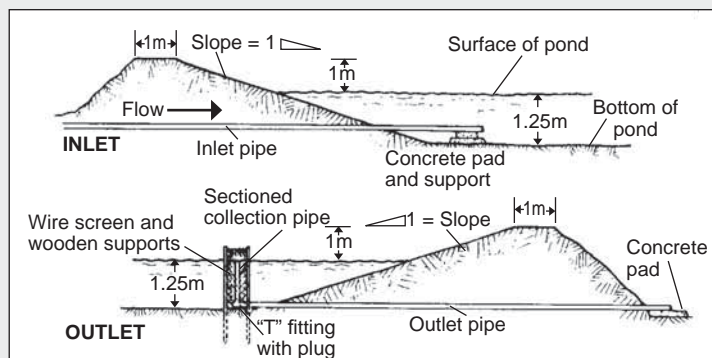



### Finishing Embankments

Fill in the gaps in the embankment that were used for laying pipe or removing excavated soil. Thoroughly tamp the top and slopes and make them uniform with the existing embankment.

Line the entire inner face of the embankment slope with rocks and flat stones, clay or High Density Polyethylene (HDPE) lining as specified. This will prevent erosion due to wave action during pond operation or seepage in the case of clay and HDPE lining. Rocks and stones should be smoothly graded to conform to the design slope of the embankment. Avoid using gravel and pebbles because this material tends to move down slope.

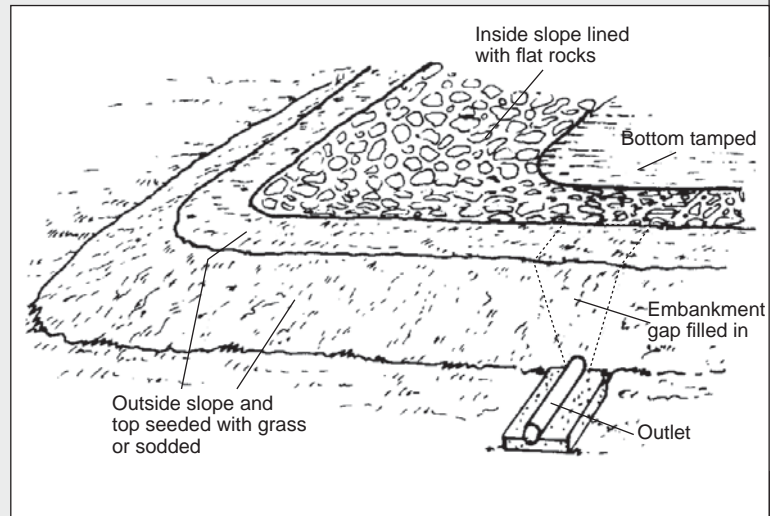

If topsoil was initially removed from the site, use it now to cover the outside slope and top of the embankment and plant grass seed. This will help prevent erosion of the embankment from wind and rain.

Excess soil excavated from the pond can be used to build small dams to divert surface water away from the pond. If not, it should be graded level or hauled away from the pond site.

Source: Lifewater International

## 5. SOLID WASTE MANAGEMENT

All SOL historic and modern human activities generate waste from unwanted or unconsumed materials from places such as residential house, different types of markets, schools and colleges, community centres, commercial centres, offices, industries, and so on. If left uncollected and appropriately disposed of, this waste or refuse soon becomes a problem to the environment in which we live. It adversely affects public health and the aesthetic quality of the environment.

In South Africa alone Municipal waste collection coverage increased by only 2.7% between 1996 and 2001 countrywide. As of the year 2007 approximately 50% of the population was still not receiving a regular waste collection service. The metropolitan municipalities were delivering an almost complete service, while local municipalities in many remote rural areas had no waste management service at all.

Uncollected solid waste can be a nuisance, encouraging the breeding of insects and other pests, creating smells, polluting the water, polluting the air when burnt and generally harming the environment.

There is therefore a need to put in place a mechanism to timeously attend to the waste generated by our activities. Solid waste management is concerned with operating a system of minimizing, storing, collecting, recycling and disposing of refuse.

Most low-income housing sites have at worst no Solid waste management systems and at best poor systems. Usually Municipalities or Local Authorities are considered responsible for managing solid waste, but in most cases they are unable to carry out their duties effectively mainly due to lack of resources, poor planning and prioritization. At the same time the communities do not consider themselves as being responsible for this service. However, community participation in waste collection and street cleaning on low-income sites may be a sustainable practical solution in the short to medium term.

A lot of literature is available on Solid Waste Management from various countries and Institutions. This chapter therefore shall concentrate on its associated employment intensive activities and potential for creating jobs whilst at the same time providing a clean living environment.

Solid Waste management also has a potential for the development of small, medium and micro enterprises and skilling of workers involved in waste collection, recycling and disposal activities.

### 5.1 OBJECTIVES OF A SOLID WASTE MANAGEMENT SYSTEM

The objectives of solid waste management system are to ensure safe and clean living environment, protecting loss of life and property and ultimately mitigating adverse impacts on the natural environment. This is achieved through systematic planning, implementation and monitoring of minimizing, storing, collecting, recycling and disposal of refuse.

In particular, the system should seek to:

- collect solid waste from houses or communal points regularly and reliably;
- eliminate solid waste from drains, roadsides, open plots and from around solid waste storage facilities;
- disposal of collected waste in an economic and hygienic way; and
- allow for recycling of useful materials.



## 5.2 IMPORTANCE OF WASTE MANAGEMENT

Proper Waste management has short and long term benefits to community health, quality of life and environmental protection. It also enables anticipation of associated problems and their mitigation. It is therefore essential to develop efficient management practices because of risks such as:

Uncontrolled burning of waste pollutes the atmosphere. It may produce poisonous gases which might cause diseases like cancer. Also, certain kinds of waste like spraying cans can explode causing injury.

Uncontrolled burying of waste can pollute the ground water and in turn contaminates water sources. This also may produce poisonous gases which might cause diseases like cancer, or produce gases which might burst into flames.

Uncollected piles of waste attract animals and insects which are harmful and can spread diseases. Sharp objects like needles, broken glass and blades, and other dangerous (hazardous) waste might be present in waste piles and may harm human scavengers in particular children and animals. Piles of waste are unsightly, they emit odour and make people nearby feel uncomfortable generally reducing the aesthetic value of the environment. It also blocks drains, leading to flooding and blocked access routes. Therefore, good practice in solid waste management is very important in order to avoid these risks to our health and the environment we live in.

### 5.2.1 MAIN WASTE MANAGEMENT OPTIONS

There are three main options for dealing with waste. These include:

- Collection, storage, transporting and disposal of waste at a designated and well protected landfill site. In this case waste remains as waste.
- The re-use of waste, or recycling of waste, including composting of any waste which can rot. In this case waste becomes something useful again or becomes a source of useful products.
- Treatment of waste which includes controlled burning and controlled burying of waste. In this case waste can become a source of useful energy, for example gas for cooking. Usually a combination of all three is necessary to efficiently manage waste.

### 5.3 THE SOLID WASTE CYCLE

Figure 5-1 below illustrates a typical solid waste cycle. Note that the cycle depicted below is generic and in practice several variations have been adopted.

**Figure 5-1: Typical Solid Waste Cycle**

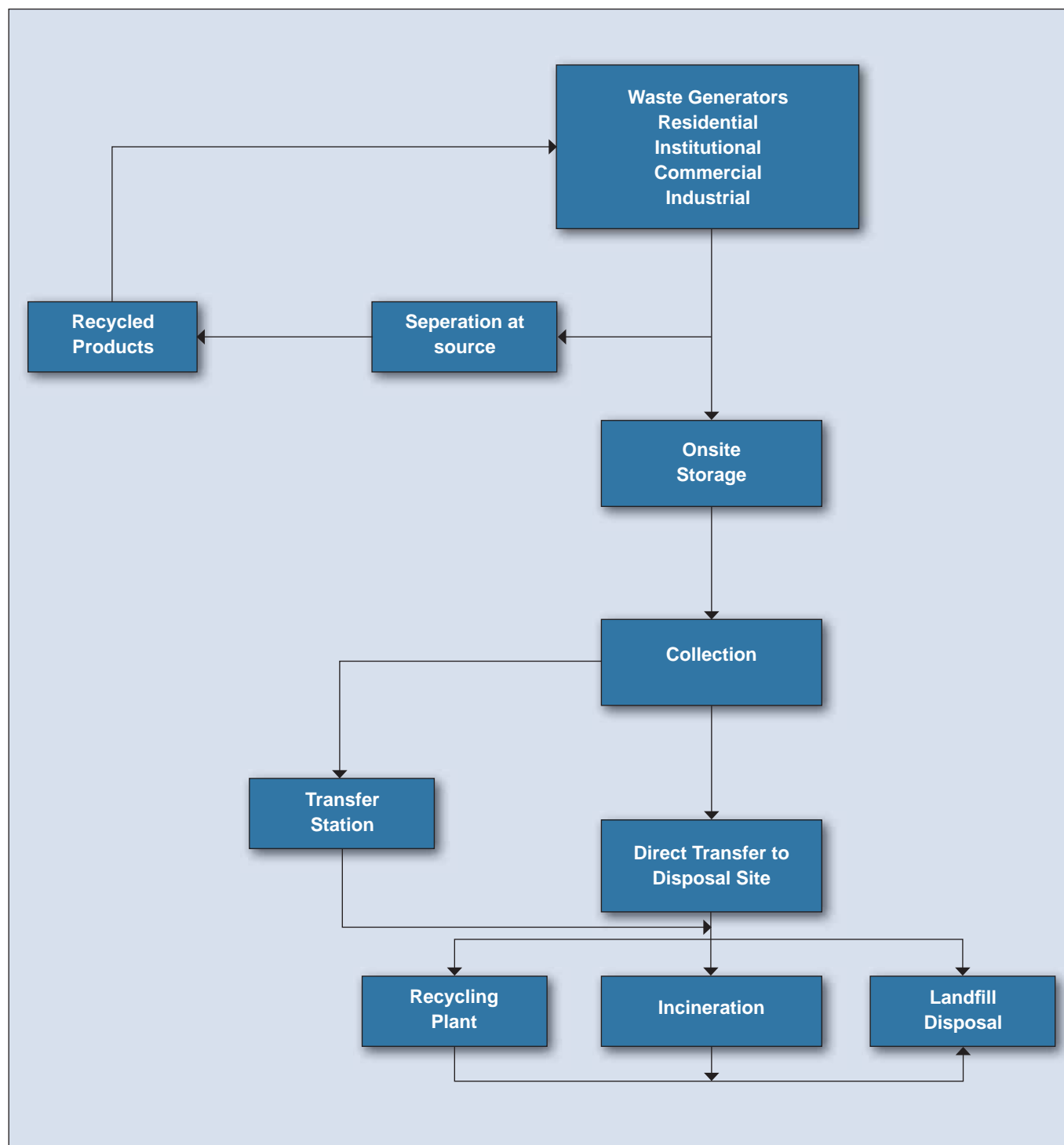

Source: CSIR





## 5.4 SOLID WASTE TYPES AND GENERATION RATES

Wastes can broadly be classified in the following categories:

### 5.4.1 HOUSEHOLD WASTE

This refers to solid waste composed of garbage and refuse generated by households or homes. In high-density neighbourhoods up to two thirds of this category consists of organic waste, including ash produced through traditional cooking and soil from floor sweeping. In communities where there are inadequate sanitation facilities, the waste might also include human excreta.

### 5.4.2 COMMERCIAL WASTE

This is generated by business places such as stores, markets, office buildings, restaurants, shops, bars, etc. Commercial waste typically consists of packaging and container materials, used and discarded office stationery and equipment, food waste, etc.

### 5.4.3 INDUSTRIAL WASTE

Industrial waste comes from processing industries. Industrial waste might include unused raw materials, undesirable by-products, carbon based solid waste, chemical waste, some of which may be hazardous waste.

### 5.4.4 INSTITUTIONAL WASTE

These are waste from police camps, Army barracks, schools, prisons, and other public buildings. Where the institution involves residents, the waste composition is similar to those from households. Some institutions, e.g. hospitals, can generate hazardous waste.

### 5.4.5 MEDICAL WASTES

Are Institutional but need care as they may cause public health problems. They consist of discarded syringes, body tissue, swabs and other contagious wastes.

### 5.4.6 STREET WASTE AND LITTER

These include dust/sand, leaves, paper, etc. In high-density neighbourhoods, street sweepings might also contain household refuse, drain cleanings, and human and animal excreta.

### 5.4.7 WASTE FROM AGRICULTURE AND FORESTRY (PESTICIDES)

These include garden, agricultural waste, containers (fertilizers, pesticides etc.), dead Animals etc. These require specialist handling.

### 5.4.8 MINING AND POWER STATION WASTE

These include fly ash, gravelly material etc. There is potential for recycling some of the non-hazardous wastes from mines and Coal and other Thermal Power stations.

### 5.4.9 CONSTRUCTION DEBRIS

The nature of construction waste depends upon the materials used for the purpose of construction. It can contain, wood, brick-stones, concrete, glass, and metals, to name a few.

Hazardous wastes which can be generated by industries, hospitals and other sources should be handled and disposed of by specialists who are specifically trained for that purpose. Normal waste collectors should however be trained to

at least differentiate and/or identify hazardous wastes and take steps to report them with urgency. Figure 5-2 below further illustrates classes of hazardous wastes.

For planning purposes and depending on the location, household waste is generated on a rate of 0.25kg/person.day in low income areas to 1.0kg/person.day in high income areas. The volume generated can vary from 0.4 litres/person. day in very poor rural communities to 10 litres/person.day in very affluent communities. Table 5-1 gives indicative waste generation rates for various conditions:

Figure 5-2: Types of Waste

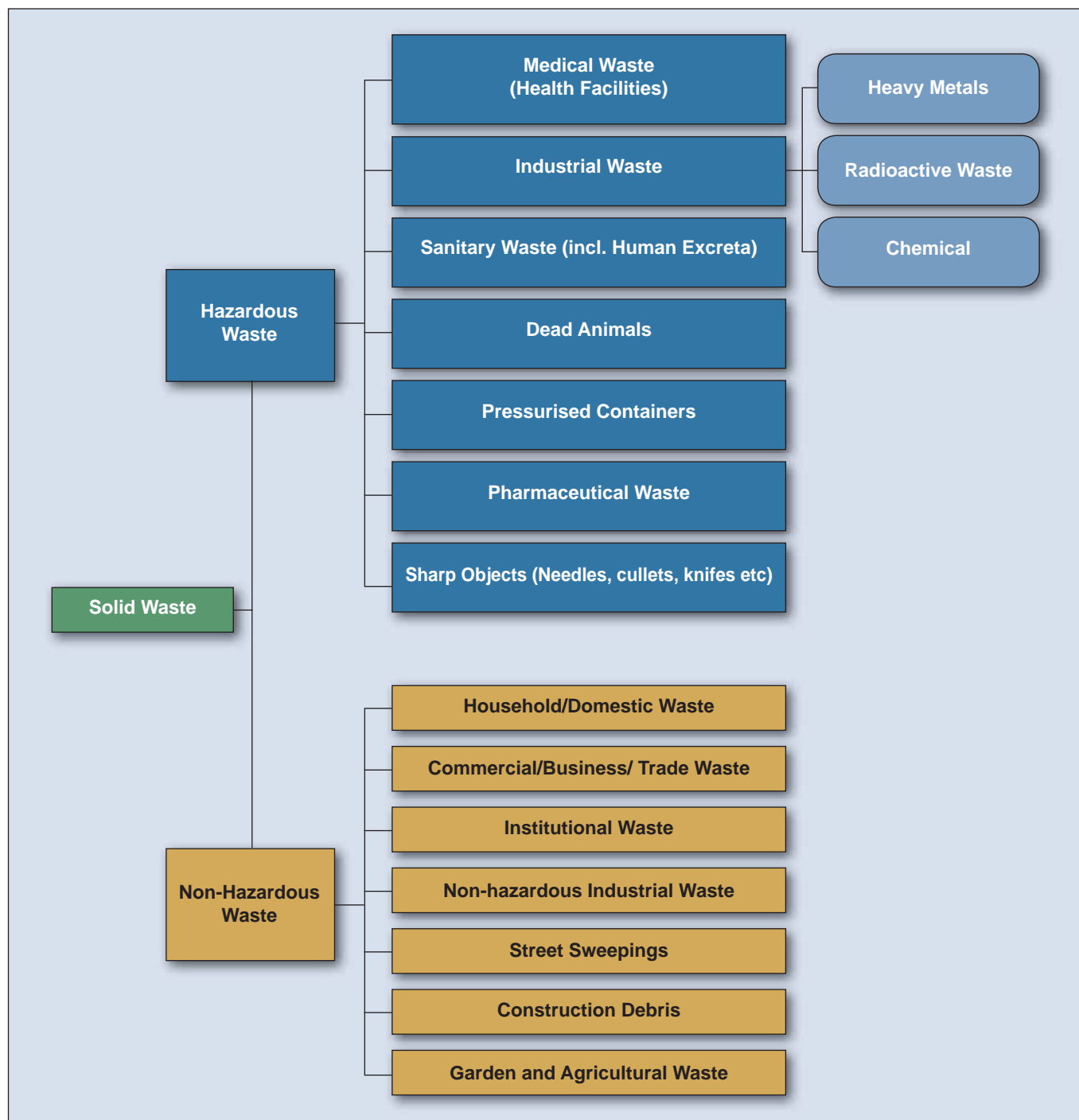

Source: ILO



Table 5-1: Typical Waste Generation Rates

Land use	Generation rates kg/person.day		
	Low-income country	Middle-income country	High-income country
Mixed urban waste - large city	0.50 to 0.75	0.55 to 1.1	0.75 to 2.2
Mixed urban waste - small to medium city	0.35 to 0.65	0.45 to 0.75	0.65 to 1.5
Residential waste only	0.25 to 0.45	0.35 to 0.65	0.55 to 1.0

Source: World Bank

## 5.5 WASTE MANAGEMENT PROCESSES

The principal elements of a solid waste management system are Waste minimization, Recycling, Storage, collection, transport and disposal.

These processes are described in detail below:

### 5.5.1 WASTE MINIMISATION

Waste minimisation comprises any activity to prevent the formation of waste or reduce the volume and/or environmental impact of waste that is generated, treated, stored or disposed of. There is a greater responsibility on Industry especially Consumer Goods Manufacturers to reduce waste through reengineering of their practices. The following advantages accrue if production of waste is minimized which is mainly the reduction of:

- The quantity and toxicity of hazardous and solid waste generation;
- Raw material and product losses;
- Raw material purchase costs;
- Waste management record keeping and paperwork burden;
- Waste management costs;
- Workplace accidents and worker exposure;
- Compliance violations; and
- Environmental liability.

At the same time, waste minimization can improve:

- Production efficiency;
- Profits;
- Good community relations;
- Employee participation morale;
- Product quality; and
- Overall environmental performance.

There are also indirect benefits to public health since quantities of waste are reduced. Improved efficiencies and better profits would translate to more opportunities for employment and skills development.

### 5.5.2 RECYCLING

Recycling of waste refers to the separation at source of recyclable materials from the general waste stream and the reuse of these materials. The objectives of recycling are to save resources as well as reduce the environmental impact of waste by reducing the amount of waste disposed at landfills. To meet these objectives, waste separation at source is desirable, as the quality of recyclable materials is higher when separated at source. In addition, recycling has the potential for job creation and is a viable alternative to informal salvaging at landfills, which is undesirable due

to the problems of health and safety associated with salvaging. According to the EPA the recycling process refers to the collection and processing of secondary materials, manufacturing recycled-content products, and then purchasing recycled products. This creates a loop that ensures the overall success and value of recycling.

Materials with a high potential for recycling are:

- waste paper, like newspapers, magazines, cardboard, books, letters and the like;
- Base metals, for example scrap metal, beverage (aluminium) cans, iron, copper, etc.;
- Precious and semi-precious metals;
- textile cut-offs that can be used for the production of door mats, cushions, mattresses, homemade caps and duster coats, stuffing dolls and so on;
- plastic, such as broken buckets, containers, etc., that can be re-melted and made into new products;
- Wood to make pallets;
- Lead-acid batteries;
- Used oil and lubricants;
- Glass Cullet for use in fibre glass insulation;
- Coal Fly Ash for use in concrete manufacture;
- Ground granulated blast furnace slag (GGBF) for use in cement manufacture;
- Hazardous waste burned in boilers and industrial furnaces.

The sale of recyclables can be a profitable business. Before starting the business it is advisable that an Economic Feasibility study be undertaken followed by the development of a sound business plan. All recyclables need to be separated from waste, and they need to be sorted and cleaned. They then need to be transported, processed and marketed. The cost of all of these activities must be compared to the potential price for the finished product.

Recyclables can be separated at different locations. Separation at source means that the producers (of the waste) are already sorting the recyclables from the waste. In fact, not mixing the recyclables with unwanted waste at source is preferred. It is also possible to separate the recyclables at the transfer stations. The disadvantage of this option is that the recyclables are more contaminated and that it takes more effort to clean them as well encouraging human scavenging.

UPVC, HDPE and rubber can be recycled to make landscaping products such as hosepipes, garden edging and fence posts.

### Composting and Landscaping

A special form of recycling is composting. Compost is used in farms and gardens as a soil conditioner by giving it more air and it has a high capacity to bind water. Especially in arid areas this is a great advantage. Unfortunately there is often no existing demand for compost. Before starting commercial production there is a need to study how best to use the compost for example for growing vegetables for the market or to sell the compost directly.

Compost normally comprise of organic matter (yard trimmings, vegetable leftovers and/or food waste etc.) stored under certain temperature and humidity conditions. Like any other recyclable it is important to use unpolluted organic matter, thus no glass, metal, plastics, paper or stones should be mixed with the compost. Compost is produced by micro-organisms, which eat the organic material. The best compost is produced when these micro-organisms have enough oxygen. The outside 15-20 cm of the pile has to have enough oxygen for the composting process. The amount of oxygen can be increased by laying the compost on a rack made of timber or any pieces of wood and by turning the pile every two or three days for a period of two or three weeks.

The optimal moisture content for composting is between 50% and 65%. Like all other organisms, micro-organisms need water to live but do not want to drown. To prevent evaporation by wind and sun, it is advisable to provide a



suitable roofed open shed and wind break for the composting area. The roofing shall also protect the compost piles against rainfall.

A composting facility should have enough space to store the anticipated compost for at least one month. It should have a roof covering to protect the workers from the sun and the rain. The structure can be made from recovered timber and other simple materials.

### 5.5.3 STORAGE

Basically there are two ways of storing waste before collection and disposal. These are Storage at source and Communal Storage.

#### Storage at the Source

Usually all solid waste will be stored at the source for some time normally a week. Sources of waste are individual households, shops, industries or offices. Sometimes waste is stored in a container or a disposable plastic bag. Ideally, waste of individual households/commercial entities is stored in galvanised steel or plastic bins with a lid. Larger Bulk containers are already in use in some organized Cities like in South Africa and they serve mostly commerce, industry and affluent high density developments such as Flats and Town House developments. However, these types of containers are usually not easily available. Many low-income households use small containers for which no other use can be found, or make a small pile of waste outside the house.

For people in the high-density unplanned settlements, storage at the source can be a big challenge. Often they do not have enough space to store a large amount of waste or enough money to buy a suitable container or disposable bags. Communal storage systems are viable for the high density and informal settlements.

#### Communal Storage

Sometimes waste is dumped by households in a community collection point and from there it is transported to a transfer station which will be emptied by the local authorities.

Transfer stations are established for economic reasons in urban areas which have long haulage distances to the final disposal sites. Small collection vehicles (handcarts, wheelbarrows) bring in waste collected at their source of generation or from communal bins, and larger vehicles from the Municipality or a private contractor transport them away to the final disposal site.

- Communal storage, such as collection points within the settlement or transfer stations at the border of the settlement, can have different forms (See Figure 5-3 below).
- The cheapest form is open dumping places called collection points. The waste is dumped somewhere on the street or in an open area. The environment is not protected against the waste. Open dumping places are sometimes improved by fencing them with a wall made of concrete, masonry, timber or iron sheets. The dumping place is still easily accessible. Open dumping places have some disadvantages as they are easily accessible by scavengers and they often have odour nuisance. Their location must consider:
  - a) Accessibility – if it is too far from residences, people will continue to dump indiscriminately. It is recommended that a walking distance of approximately 200m to the designated transfer station;
  - b) Risk of damage to health and the environment. Such dumping sites are associated with risk of flies, rats, pungent odours and ideally they should be located far from residential or commercial developments. It may however be difficult for a community in a low income area to agree on the location of a communal storage point as space is scarce.
- Another form of permanent dumping places are formal properly designed facilities. They sometimes have special facilities for easy dumping and collection for further transport by a truck.

Figure 5-3: A typical Rural Transfer Station

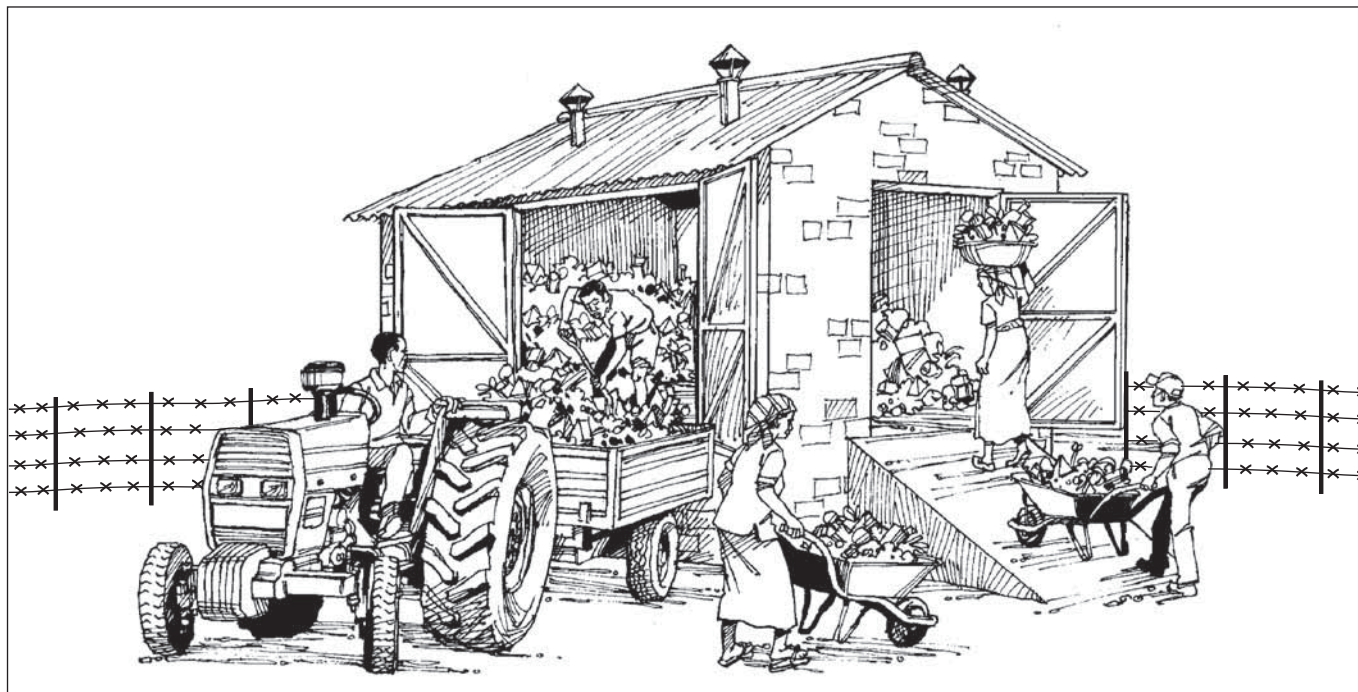

#### 5.5.4 COLLECTION OF WASTE

In general there are two ways to collect waste:

- collection of stored waste
- street sweeping

##### Collection of stored waste

- The collection of waste can be divided into primary collection and secondary collection.
- Primary collection refers to the collection and transport of waste within the community.

Secondary collection refers to the collection and transport of waste from the community to the municipal disposal site, usually an approved landfill. Local authorities normally carry out secondary collection using a truck or tractor and trailer combination. In most cases the Local Authorities requests the communities to pay part of the cost of secondary collection through levies, rates or service charges.

In urban areas it is normal to collect waste from the generators and transport it directly to a landfill site if the landfill site is located within a reasonable distance of the developments.

Choice of the primary and secondary collection and transport method depends on many factors like:

- Onsite storage method;
- waste generation rate and composition;
- availability and cost of collection equipment;
- participation of the community;
- population density in the area, the width of the streets, road conditions, distances, etc.;
- willingness and ability of residents and/or council to pay for waste collection services.

The collection of communally stored waste can only be successful with the participation of the community. If the people in the community think that the distance to these communal dumping points is too far, they will not make use of them. A global rule is that the walking distance to a dump site should be between 150 and 200 metres.



In case of collection at household level, the Municipality or a Contractor collects the waste once week from the property gates on designated days.

### Street Sweeping

Sweeping of the streets can be done with either manual labour or equipment or a combination of the two. To ascertain the time needed to clean streets and drains, it is important to determine the following:

- Weather elements include rainfall, wind (runoff, erosion, deposition etc.);
- Volume of pedestrians using the area to be served;
- Length of road networks and type of road surface material (degree of compactness and permeability of the surface);
- Type of trees and vegetation in the road servitude;
- Degree of commercial activity on the streets;
- Traffic volumes;
- Type of developments on the streets such as offices, churches, bus termini and railway stations, schools, post offices, commercial centres etc.); and
- Markets, fairs, Flea markets public events.

### Classes of Street Waste

The type of waste from the streets may be classified as follows:

- **Waste originating from the street** itself (dust, soil, mud etc.), produced by weather conditions and traffic
- **Seasonal waste** (leaves, twigs, soil deposits in drains and so on) produced by weather conditions or consequent human intervention, which is limited to certain periods of the year;
- **Recurring waste** (general litter – paper and tin cans) mostly originating from lack of respect for the environment by users, in general shop and bar owners etc., who clean their properties and dispose of their rubbish in public areas. This kind of waste usually accumulates at certain times of day and almost always in the same places (e.g. at markets, malls etc.);
- **Casual waste** (empty cigarette packets, cigarette ends, matches, tickets, receipts, sweet papers, animal waste, oil leaks from vehicles, unwanted leaflets etc.) caused by normal pedestrian traffic and vehicles, and which varies with their frequency;
- **Exceptional waste**, usually bulky waste which people occasionally throw out on the streets (e.g. unwanted furniture);
- **Hazardous Waste** such as dead animals, chemicals, syringe, sharp objects

### Manual Street Sweeping

In most developing cities street sweeping using manual labour is the most appropriate option to collect and transport the waste from the streets. As good practice and in line with current legislation waste workers should be afforded adequate protection in the performance of their duties. It is also ideal that they have access to first aid within a reasonable distance. Ideally they should receive Regular Health check-ups preferably at least once a year. The following equipment and Personal Protective Equipment are proposed per worker:

- A Boiler suit
- Safety shoes
- UPVC Gloves
- Dust Masks
- Transparent goggles
- Long-handled outdoor broom
- Hand brushes for sweeping rubbish onto dustpans and bins
- Shovel/rake, fan
- Drain clearing poker
- Plastic bins/sacks for waste (2 to 5 per worker per day)
- Long-handled pincers and air-tight bins for collecting used needles
- A Push Cart

### Common Street Sweeping Hazards

The Street Sweepers are constantly exposed to risks due to exposure to hazardous materials, which have short term and even long term health significance if not properly addressed. Street sweepers must therefore be trained on basic Health and Safety procedures. Their training should cover the following broad topics:

- Cuts and wounds from sharp objects;
- Contamination from hazardous waste such as hospital waste, chemical
- Waste or handling dead animals;
- Air pollution: respiration problems from the fumes that are generated by waste as well as dust created by sweeping;
- Other diseases transmitted through solid waste and through direct contact with exposed skin;
- Muscle and back strains due to wrong posture or having to lift heavy waste;
- Road accidents.

Training in mitigation of hazards should include:

- Ensuring use of protective gear such as dust muffs, gloves, boots, dust masks, goggles (PPE);
- Ensure availability of first-aid kit within reasonable reach of the work site;
- Use reliable equipment and maintain it in good condition;
- No alcoholic drinks or drugs during work;
- Workers should undergo medical check-ups regularly (at least once annually);
- Do not eat or drink anything while working;
- Workers to wash hands and face before leaving the place of work or before eating.

Table 5-2 below gives an outline of specific health risks associated with solid waste collection and recycling and how they can be controlled.

**Table 5-2: Specific health risks associated with solid waste collection and recycling**

Potential Health Hazard	Causes	Control Measures
Dermatitis and skin diseases	Wet work Contact with dust Contact With Chemicals	Contact with wet material is often unavoidable; protect hands by wearing gloves. Hands should be thoroughly dried after washing and before pulling on gloves.
Bacteria and Viruses	These enter body through: Breathed Air Swallowing Cuts and wounds	Mouth Muffs Reduction of dust emissions by sprinkling water Training
Tetanus	Cuts by sharp objects, such as wood shards, nails, metal etc. penetrating tissue.	Remove nails from timber and avoid walking on waste or recyclable loads and piles. Wear protective shoes, boots or clothing. Vaccination
Leptospirosis (Weil's disease)	Rodents in Waste	Wear suitable protective gloves, shoes, boots, trousers, and/or clothing. Avoid handling bags and other receptacles accessible to rats without hand and forearm protection. Wash hands after handling any contaminated clothing or material and always before eating, drinking or smoking.
Toxocariasis	Hand to mouth contact with cat and dog faeces or contaminated material resulting in infection by: Dog roundworm (Toxocaracanis) Cat roundworm (Toxocaracati)	Request householders to securely bag or wrap pet faeces and litter. Good personal hygiene is the key here and the need (and facility) for loaders to wash their hands in cases of contamination or leakage and before eating, drinking, smoking etc is essential.





Potential Health Hazard	Causes	Control Measures
HIV and hepatitis B	Needle stick Injuries	Public Awareness on disposal of used syringes. Training.
Hepatitis A	Ingestion of infected Faecal Contaminated Material	Provide hygiene facilities, information and training. Good Personal hygiene. Immunisation.
Fungi and mould infection and allergies	Inhalation	Mouth Muffs
Salmonellosis	Hand to mouth contact with faeces or material contaminated with salmonella bacteria	Provide hand washing facilities. Good personal hygiene.
Scrotal cancer	Used engine oil, coming into contact with the worker's scrotum via soiled hands or clothing.	Provide clean clothing and washing facilities for soiled work clothing. Good personal hygiene.

Source: Adapted from Health and Safety Executive

### Manual Street Cleaning Task Rates

This involves litter collection and sweeping of streets. As already stated the amount of waste in the streets is subject to various factors and varies continuously. It is thus very difficult to set fair global task rates. At the same time if for example, a sweeper is responsible for one km of a street he may be able to collect variable waste on different days but still have to walk the same distance. The following task rates in Table 5-3 are therefore given for guidance only and should be reviewed frequently depending on the volume of waste.

**Table 5-3: Street Cleaning Task Rates**

Area	Task Rate	Activities/Comment
Parks, termini, malls	170 litres compacted litter per day, Alternatively 7,500 to 10,000 m <sup>2</sup> /wd	Litter collection and transportation to bulk container within the facility
Paved streets in City Centre	1.0 to 1.5 km/wd Alternatively 85 litres compacted litter per day	Litter collection and transportation to bulk container or Transfer Station.
Paved and unpaved streets in low density areas	1.5 to 2.0 km/wd Alternatively 170 litres compacted litter per day	Litter collection and transportation to bulk container or Transfer Station.
Paved and unpaved streets in high density areas	1.0 to 1.5 km/wd Alternatively 170 litres compacted litter per day	Litter collection and transportation to bulk container or Transfer Station.
Drain Clearing– Loose soil	5.0 m <sup>3</sup> /wd	Drain Clearing and spreading at a maximum of 4 metre throwing distance
Drain Clearing– Firm Soil	3.5 m <sup>3</sup> /wd	Drain Clearing and spreading at a maximum of 4 metre throwing distance
Drain Clearing and loading wheelbarrow – Loose soil	2.5 ~ 3.0 m <sup>3</sup> /wd	Drain Clearing and loading
Drain Clearing and loading wheelbarrow – Firm Soil	1.5 ~ 2.0 m <sup>3</sup> /wd	Drain Clearing and loading
Hauling and unloading	6.0 m <sup>3</sup> /wd	Using Wheelbarrow for a distance not exceeding 150 metres

Note: Total walking distance to and from work and within work site should not to exceed 6.0km. If not appropriate allowance for transport should be considered. Note that the task rates for drain clearing should be converted to linear measure

### Mechanical Street Sweeping



Use of Mechanical equipment such as motorized sweepers and vacuum cleaners are used for Large Cities' fully paved streets and Developments such as Shopping Malls, Major Railway Stations and Termini. Employment of Mechanical Street Sweepers and Vacuum Cleaners reduces labour requirements in favour of Capital Equipment. Combined Mechanical Sweepers/Vacuum Cleaners are also available and these are able to remove litter and dust in one operation.

### 5.5.5 TRANSPORTATION OF WASTE

#### Transport equipment

There is a whole range of possible vehicles to transport waste from one place to another. These include a range of equipment from the basic handcart to the state of the art rear loading compaction vehicles. Table 5-4 below gives an illustration of these options.

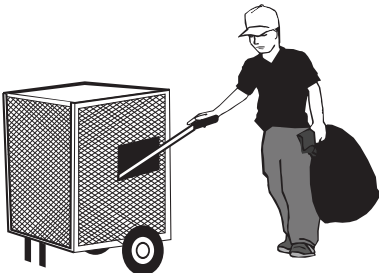
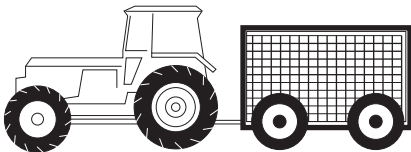
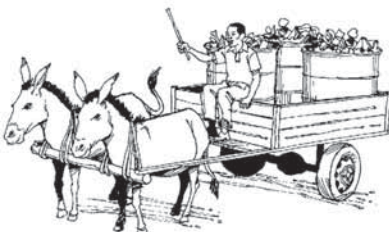
Table 5-4: Transportation options

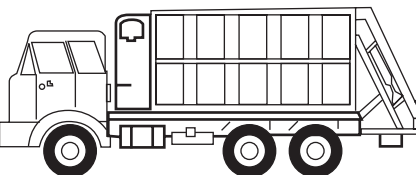
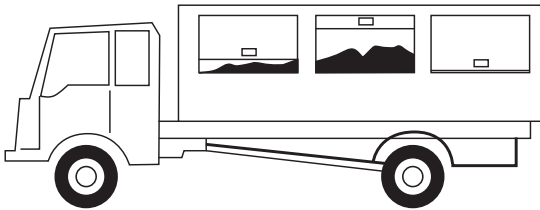
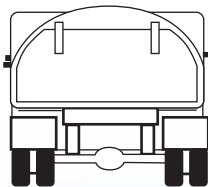
Class	Examples	Class	Examples
Hand Carts		Tractor-Trailer Vehicles	
Animal Drawn Carts		Light Delivery Vehicles	
Motorised Tricycles		Rear-end Loaders	
Side loading truck	 Side view		 Rear view

Source: CSIR



In rural, informal settlement and underdeveloped areas the terrain and infrastructure may dictate the use of animal drawn vehicles even if resources are available for more sophisticated vehicles. The following should therefore be considered when selecting suitable equipment:

- Infrastructure condition and terrain;
- Haulage distance.

The following are recommended guidelines:

Table 5-5: Recommended Hauling Distances of Hauling Equipment

Equipment	Infrastructure Condition	Maximum Haulage Distance
Hand Carts	No formal Infrastructure	1 km
<ul style="list-style-type: none"> <li>• Animal Drawn Carts</li> <li>• Motorised Tricycles</li> </ul>	<ul style="list-style-type: none"> <li>• No formal Infrastructure</li> <li>• Limited Road Infrastructure</li> </ul>	3 km
<ul style="list-style-type: none"> <li>• Tractor-Trailer Vehicles</li> <li>• Light Delivery Vehicles</li> </ul>	Limited Road Infrastructure	10 km
Rear-end Loaders	Proper Road Infrastructure	As necessary

Source: CSIR

- The selected vehicles should be reliable, cost efficient and easy to maintain;
- Using the same kind of vehicles in similar situations. This will ensure interchangeable of say tyres, trailers etc. in emergency situations;
- If the vehicles are to be loaded by manual labour the loading height should not exceed 1.5 metres;
- The vehicles should be easy to unload; and
- Handcart or wheelbarrows should be designed appropriately. For example they should be equipped with appropriate solid rubber tyres as there may be sharp objects on the roads.

### Collection Route Planning

Transportation of Waste is very costly and needs to be properly managed as it may be key to the sustainability of a Waste Management System. It is important that the collection route be the shortest at the same time requiring the most minimum effort. The following factors therefore should be considered in the selection of collection routes:

#### Land use

The land use will determine the volumes of waste generated. For example residential Flats will generate more waste in a smaller area and therefore may need several trips to and from the landfill or transfer station. Affluent development areas may produce larger quantities of waste per household than poorer areas. Certain industries may produce unique wastes and hence need special consideration.

#### Terrain

When using Hand Carts or manually loading it is easier to work downhill than uphill. In rolling terrain it is important that the selected route takes this into consideration.

#### Road Layout and Traffic

When working during peak hours it is important that the route chosen avoids peak traffic flow. Collection in the vicinity of access roads can be done during peak hours whilst the same can be done on major collector during non-peak times. Narrow Cul-de-sacs may require special arrangement such as reversing into or use of supplementary equipment. In access streets that are not busy it may be possible to collect waste on both sides of the carriageway in one operation whilst in busy streets this may not be possible.

## 5.6 COMMUNITY PARTICIPATION SOLID WASTE MANAGEMENT

It is of paramount importance to involve the communities in all aspects of solid waste management. This ensures that the communities take interest and assume ownership of the service. The first step in the involvement of communities is to determine the relevant stakeholders within and outside the project areas and clearly define roles and responsibilities at various levels of implementation. The involvement of both, Central and Local Government, relevant Sector Departments, NGOs/CBOs is key in the planning, implementation and monitoring of successful waste management systems. For instance properly trained CBOs can actively take part in:

- Initiatives developed at grassroots level and are likely to be sustainable as they address real needs of the people;
- Creating a sense of unity in communities and can empower people to improve their quality of life and foster a sense of personal responsibility for the environment;
- Serving their communities and always working towards their set goals;
- Taking pressure off local authorities as some responsibility of service delivery is transferred to them;
- Increasing awareness of issues in the community.

CBOs are more versatile and adapt easily to new ideas and technologies, and can also address other social issues such as drug abuse, alcohol abuse, crime etc.

Table 5-6 below gives a guide to roles and responsibilities of the various stakeholders typically involved in solid waste management.

**Table 5-6: Stakeholders Roles and Responsibilities**

Stakeholders	Roles and Responsibilities
<b>National Government</b>	<ul style="list-style-type: none"> <li>• Oversight of Local Authorities</li> <li>• Development of Environmental regulations</li> <li>• Enforcement of regulations</li> <li>• Issuing licences (Operators, Landfills etc.)</li> </ul>
<b>Department of Labour</b>	<ul style="list-style-type: none"> <li>• Facilitate Training of Workers</li> <li>• Facilitate SMME Development</li> <li>• Enforce Labour, Occupational Health and Safety Regulations</li> <li>• Set Fair Wages</li> <li>• Enforce Workers' Compensation</li> </ul>
<b>Department of Health</b>	<ul style="list-style-type: none"> <li>• Management of Health Waste</li> <li>• Health care for Waste Workers</li> </ul>
<b>Local Authorities</b>	<ul style="list-style-type: none"> <li>• Issuing WSP contracts</li> <li>• Supervision of Service Providers</li> <li>• Programme Monitoring</li> <li>• Enforcement of regulations</li> <li>• Rates collection</li> <li>• Payment of Service Providers</li> <li>• Provision of Secondary transport</li> <li>• Landfill Management</li> <li>• Managing special waste</li> <li>• Protection of Water Bodies</li> </ul>
<b>Programme Steering Committee</b>	<ul style="list-style-type: none"> <li>• Supervision of WSP</li> <li>• Programme Monitoring</li> <li>• Awareness Creation</li> <li>• Enforcement of regulations</li> <li>• Facilitate Community Participation</li> </ul>



Stakeholders	Roles and Responsibilities
<b>Waste service Provider:</b> Municipality CBOs SMMEs Corporates	<ul style="list-style-type: none"> <li>• Provide waste collection services</li> <li>• Awareness Creation</li> <li>• Enforcement of regulations</li> <li>• Primary transport</li> <li>• Secondary transport</li> <li>• Cleaning of roads</li> <li>• Cleaning of drains</li> <li>• Buy materials for recycling</li> </ul>
<b>Community at Large</b>	<ul style="list-style-type: none"> <li>• Payment of services</li> <li>• Transfer waste to designated places of collection</li> <li>• Awareness creation</li> <li>• Cleaning of side walks</li> <li>• Minimising waste produced</li> <li>• Separating recyclables</li> </ul>
<b>NGOs/CBOs</b>	<ul style="list-style-type: none"> <li>• Community Facilitation</li> <li>• Awareness creation</li> <li>• Funds Mobilisation</li> <li>• Community Training</li> </ul>
<b>Industry and Mining</b>	<ul style="list-style-type: none"> <li>• Management and safe disposal of Hazardous Waste</li> <li>• Social Responsibility Programmes</li> </ul>

## 5.7 SKILLS AND ENTREPRENEURIAL DEVELOPMENT

Pollution has grown over the last thirty years worldwide to unacceptable levels. Urban Cities are decaying and polluted, whilst rural areas have remained under developed and polluted without meaningful waste collection services. The introduction of waste management services in rural and un-serviced densely populated areas presents opportunities for Emerging Small and Micro Enterprises. Depending on their capabilities these enterprises can be engaged to provide the following services:

### Primary Collection and Management of Transfer Stations:

This service may involve door-to-door waste collection for households. In informal settlement the service may involve receiving and sorting waste at Transfer Stations.

### Street Sweeping:

The service usually involves street sweeping and transferring the waste to transfer stations, landfill sites or designated collection points. Waste can also be collected from illegal dump sites and transported as necessary to designated points of collection or disposal.

### Recycling:

This service may include sorting and recycling of waste. Entrepreneurs can add value to high quality waste as indicated in Section 5.5.2 above.

### Waste Transportation:

This service involves transportation of waste from designated collection points to designated disposal sites. To ensure viability enterprises involved in waste transportation may provide allied logistical services such transportation of water, fuel, coal and other goods and services.

### **Operation of Landfill Site:**

This may involve development, control and operation of landfills and incinerators. Operators of such sites need some level of capital thus joint ventures between Small and Micro enterprises and Established Companies are encouraged.

The advantages of employing and Small and Micro Enterprises in Waste Management include:

- Coverage of waste management services can be increased to cover rural areas and informal settlements.
- They offer the service at an economic cost.
- In certain areas they may provide a more reliable service compared to Local Authorities.
- They create decent jobs for local population.
- They may provide innovative solutions compared to bureaucracies of Local Authorities.

#### **5.7.1 CHALLENGES FOR EMERGING ENTERPRISES IN WASTE MANAGEMENT**

The challenges faced by Emerging Enterprises include the following:

- Large Cities are reluctant to engage Small and Micro enterprises as their engagement entails more oversight on the part of the City compare to that when large Enterprises are engaged. Risk averse Municipal Managers are reluctant to engage in risky contracts.
- Some Entrepreneurs are reluctant to participate in waste management as some sections of society look down upon this line of business.
- Most Local Authorities especially rural ones have no capabilities to manage Small and Micro enterprises in waste management. Lack of monitoring systems may adversely affect quality of service
- Local Authorities may be reluctant to enter into long-term contracts thus discouraging emerging Enterprise to invest in this business.
- Inaccurate pricing may result in losses for Enterprises.

#### **5.7.2 CREATING AN ENABLING ENVIRONMENT FOR EMERGING ENTERPRISES**

Government and Local Authorities need to contribute by ensuring that the environment in this business sector is conducive for the sustainability of emerging enterprises. The following actions by authorities can positively contribute to this goal:

- Enacting suitable Legislation and formulating suitable Policies and Administrative processes for the business.
- Establishing effective communication protocols for all stakeholders.
- Facilitating access to capital for the Emerging Enterprises.
- Implementing Public Awareness campaigns to ensure public support for waste management.
- Provision of Technical Support including Business and Technical Training for Entrepreneurs.

Technical and Business Manuals may be obtained from the ILO and other relevant Institutions. ILO can also arrange training for Officials and Entrepreneurs on Waste Management.



## 6. SETTING OUT OF WORKS

Setting out is the process of determining the correct horizontal and vertical alignment as well as positioning of an infrastructure asset on a project site.

Proper setting out is very critical to the technical and economic success of a project. In infrastructural projects such as water or wastewater pipelines it is critical for the infrastructure to traverse within given servitude without interfering with other developments. In Gravity systems it is important that design gradients are achieved so as to ensure optimal performance. Similarly, when building a house for example, errors in setting out may affect other installations such as windows and roofs and these can be very costly to rectify.

Setting out may be done by employing simplified instruments and aids or alternatively sophisticated Capital Intensive survey instruments such as Theodolites, GPS etc. However, this section focuses on the correct use of simplified instruments and aids which are readily available locally and appropriate for accurately setting out LIC works. The Capital survey instruments are expensive and are difficult to operate requiring highly specialized skills.

The following are some of the most commonly used setting out instruments used in LIC works:

### 6.1 SURVEYING INSTRUMENTS AND AIDS

There are a number of appropriate simplified instruments for setting out infrastructure and building works. The equipment one will employ is dependent on the setting out methods one adopts as well as the sensitivity of the structure and the required accuracy. For instance, in a gravity sewer pipeline levels are more important than in a pumping main. It then follows that more accurate instruments such as a Dumpy Level can be used in gravity sewer survey whereas a line level is sufficient to set out a pumping main. One should therefore carefully choose a survey method in line with the quality of work specified.

#### 6.1.1 REFERENCE PEGS

Reference pegs are used to mark the centre lines and transfer levels in pipelines. They are usually made of steel although wooden stakes can be used in remote areas. Ideally 400mm long and 12mm diameter steel rods are suitable. Pegs must be protected with stones and painted in white or yellow for visibility. Reference details should be recorded on a steel plate attached to the pegs or on the wet cast concrete.

Typically there are two types of reference pegs, namely centre line and transfer pegs. Centre line pegs are removed during excavations whilst Transfer pegs are offset at a minimum distance of 1.5m from the centreline depending on the width of the trench. To avoid loss or damage to transfer pegs they are usually embedded in concrete.

#### 6.1.2 TAPE MEASURES

Tape measures are normally made of steel and uPVC. Lengths of 20, 30, 50 or 100 metres can be employed efficiently.

Steel tapes are expensive, liable to damage and illegibility after a long period of use but are however the most accurate. Other materials although cheaper they tend to stretch and lose their accuracy. Smaller tapes of 2, 3 or 5 metres in length, are useful for small construction elements, such as valve chambers etc.





### 6.1.3 RANGING RODS, PROFILE BOARDS AND BONNING RODS

#### Ranging Rods

The ranging rods are made of hollow metal tubes, often 25mm diameter galvanised water pipe, with a pointed end of sharpened reinforcement steel. They are normally 2 metres long, and are painted red and white to make them easy to see during setting out. Ranging rods can also be made of wooden or hardened plastic poles. They can be used for setting out vertical and horizontal alignment.

Figure 6-1: Ranging Rod and Profile Boards

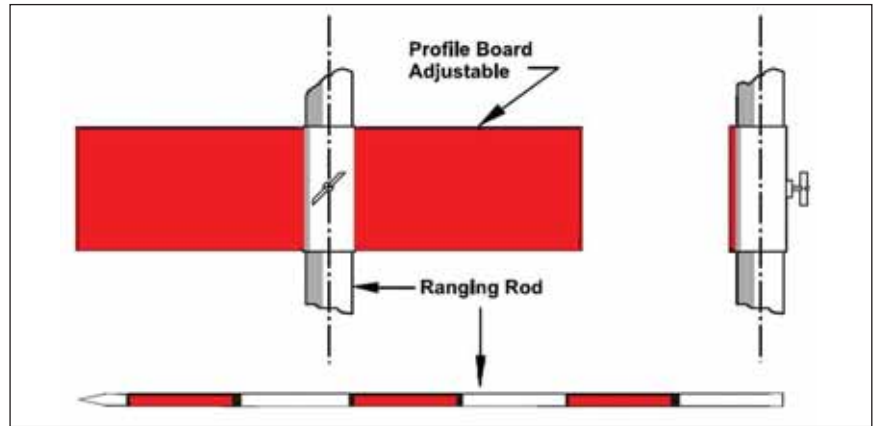

#### Profile Boards

A long lasting profile board is made from thin steel plate which is welded to a short length of metal tubing that can slide up and down and be clamped to a metal ranging rod. A useful size for the metal profile boards has been found to be 40cm by 10cm, painted red to make it easy to see. Profile Boards can also be made from timber boards. Profile boards are used for setting out levels for vertical alignment. See Figure 6-1 above.

Figure 6-2: Boning Rods

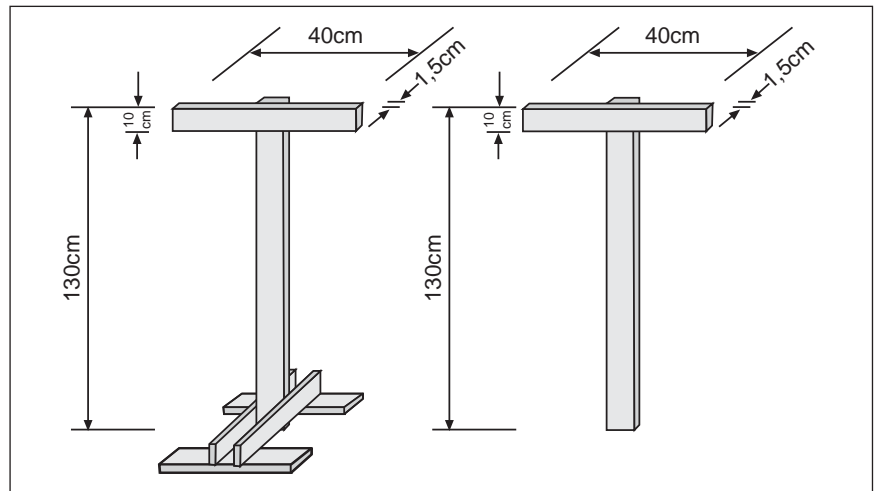

#### Boning Rods

These are generally manufactured on site from wooden laths to a "T" profile and of uniform height. A simple stand can also be manufactured if preferred as shown in Figure 6-2.

Figure 6-3: Setting out with Boning Rods

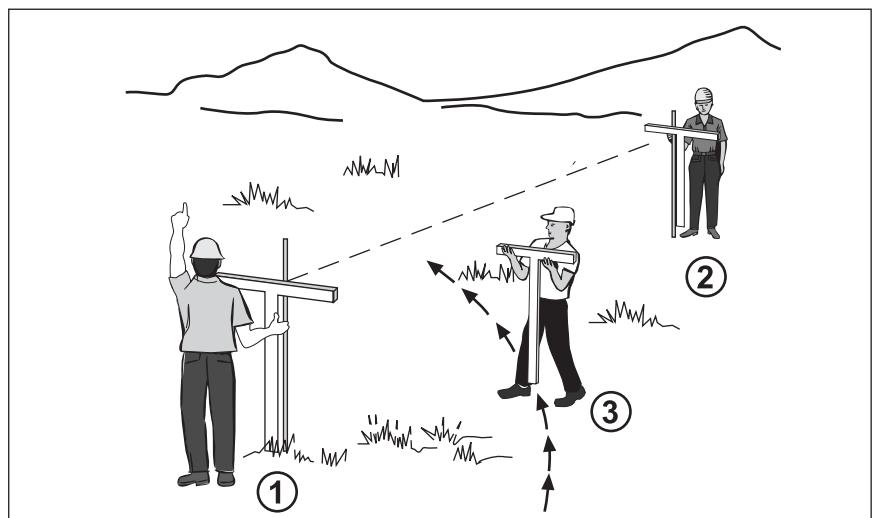

Boning rods are used in sets of three and the crosspiece is normally painted, ideally each with a different colour. They are used to establish additional levels between fixed levels (interpolation) or beyond (extrapolation) and particularly useful to check gradients of pipe trenches and finished final levels (longitudinal and transverse). In Figure 6-3, it can be seen that the ground level at Point 3 is too low and the boning rod is positioned too far to the right. By raising this boning rod and aligning it with rods 1 and 2, the bottom of rod 3 indicates the required level and its location on a straight line.

The same exercise can be carried out using ranging rods with profile boards.

The profile boards, ranging and boning rods (travellers) are inexpensive and can easily be made by a local metal work business.

**Figure 6-4: Setting out level using tube water level**

In building works the Tube water level is accurately used to transfer fixed levels which make use of the piezometric properties of water.

Before starting setting out works, make sure that you have sufficient supply of ranging rods and profile boards.

In very compact or rocky ground, it is useful to first make a hole for the ranging rod. This can be done by hammering down a metal spike produced from high tensile reinforcement steel to produce the hole. Crow bars can also be used for this purpose.

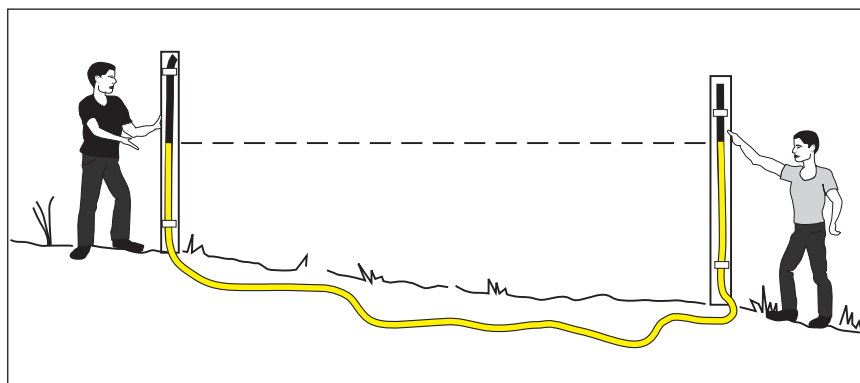

A very useful additional tool is a sliding hammer with a weighted head that fits over the ranging rod and can be used to drive the ranging rod into the ground.

#### 6.1.4 LINE LEVEL

The level of each of the profile boards can be controlled by using a line levels. The line level is a short spirit level (about 100 mm long) with a hook at each end to hang it from a nylon string (fish line). It should be hung at approximately the mid-point between the two ranging rods.

This instrument needs at least two persons to operate - one at the end of the line, and the second to watch the spirit level. The line operator moves the string up or down until the bubble is centred in the middle between the spirit level marks.

**Figure 6-5: Line Level**

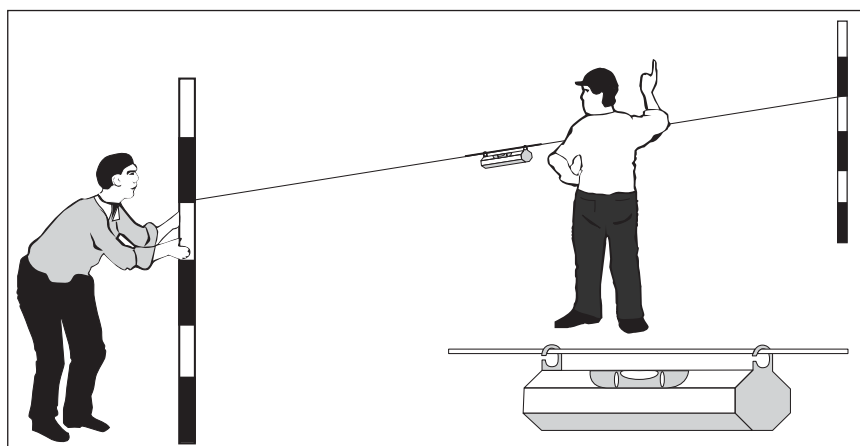

The string line will then indicate the horizontal line. The line level can be used to:

- Transfer the exact level of one profile board to another profile, thereby ensuring that both are at the same level,
- Measure up or down from a known horizontal level, and set a new level, and
- Find the slope between two fixed profile boards, and determine which one is higher.

The line level has an accuracy range of up to about 50 metres beyond which its accuracy might be reduced. It is easy to carry around and with care can be used for setting out levels and slopes not flatter than 1 in 300.

Points to remember when using a line level:

- The string used should be a thin nylon fishing line, enabling the line level to easily slide along the string.
- The line level must be placed half-way between the two ranging rods. Use a measuring tape to find the exact middle point.



- Keep the string tight - do not let it sag.
- The line level is a delicate instrument, look after it - do not throw it around and treat it roughly.
- Check the accuracy of the line level regularly in the field.

The following procedure should be followed to check accuracy of line level:

- Place two ranging rods 10 metres apart.
- Fix a fish line at 1 metre mark on one of the rods and transfer the level to the other rod using the line level and mark this level.
- Keeping the fish line in place turn the line level around and adjust the fish line again.
- Mark the new level and measure the distance between the two levels.
- If the difference is less than 10 centimetres the correct level shall be in the middle of the two marks. If the difference is more than 10 centimetres then the line level should be replaced.

## 6.2 SETTING OUT STRAIGHT LINE

For most projects straight lines must be established, for example the centre line of a pipeline, house foundation and the like.

### 6.2.1 INTERPOLATION

The two end points of the straight line to be established are each marked with a ranging rod. The intermediate points can be found by sighting from one end rod to the other and moving a third rod until it is aligned with the two end rods (see Figure 6-6).

**Figure 6-6: Setting out a straight line with ranging rods (interpolation)**

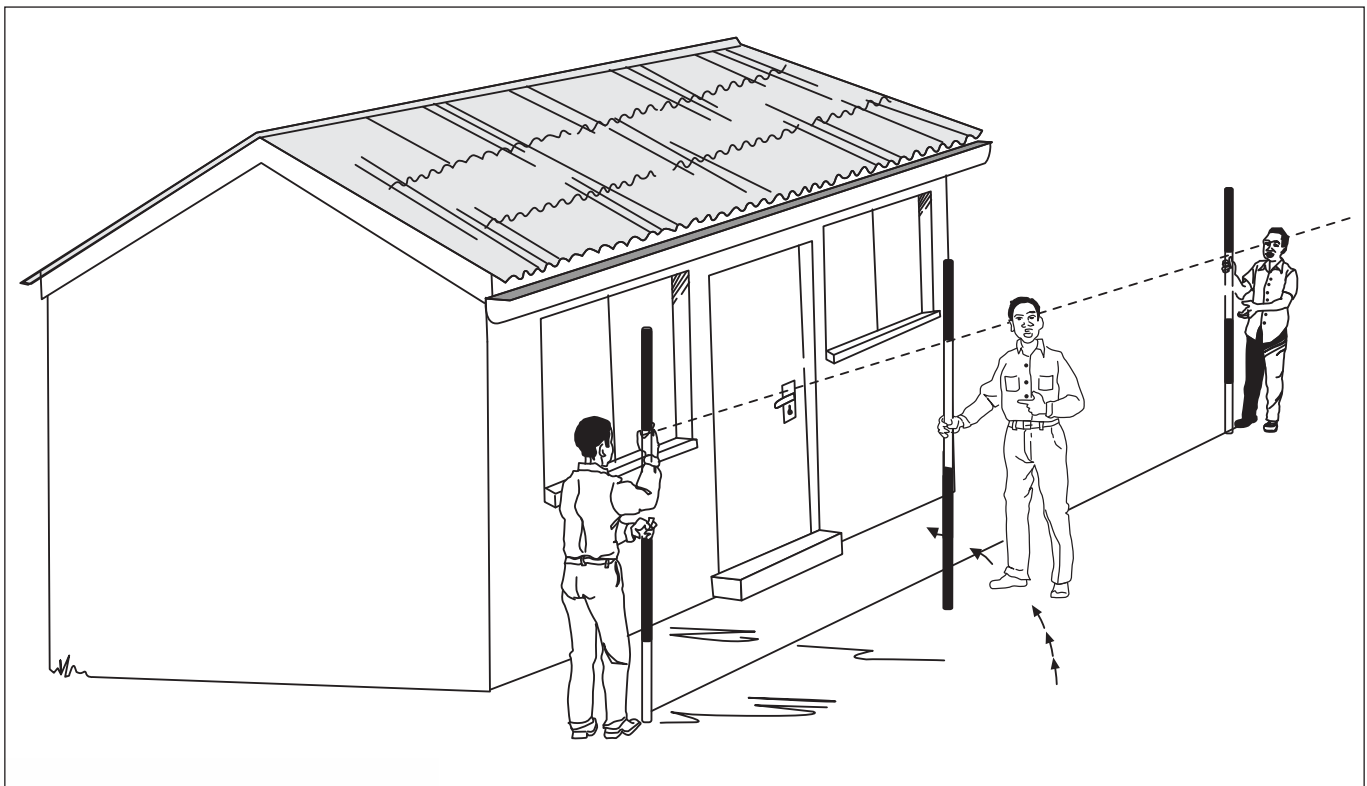

## 6.2.2 EXTRAPOLATION

Figure 6-7: Setting out a straight line with ranging rods (extrapolation)

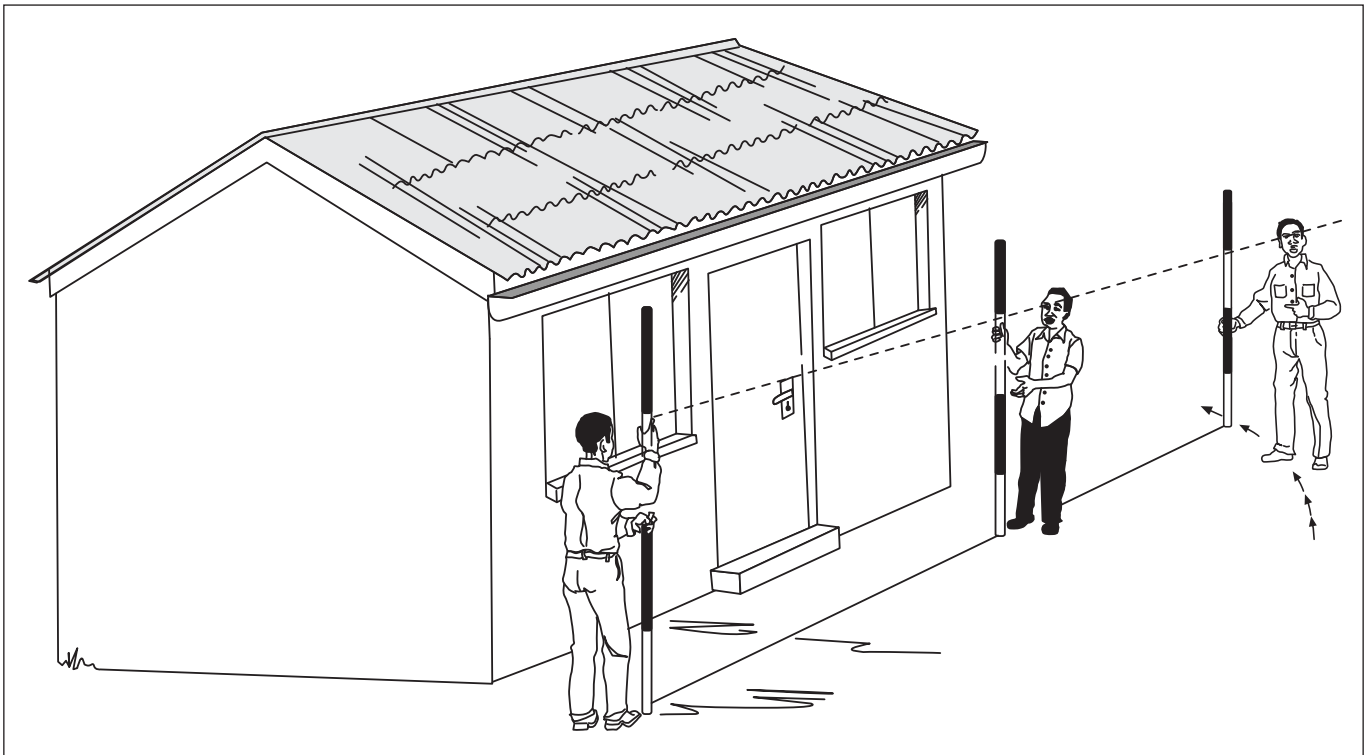

The same procedure can be used to extend a straight line. Place two ranging rods at a certain distance, e.g. 10 metres, along the line you would like to establish. Walk with the third rod to the next point of the line, e.g. another 10 metres ahead. Sight the first two rods and shift the third rod until all three rods are in a straight line. Mark this point with a peg and repeat the same procedure every 10 metres until you have reached the end of your straight line. Check the entire line again.

## 6.3 SETTING OUT ANGLES

### 6.3.1 SETTING OUT A RIGHT ANGLE

- Step 1: First establish a right angle as shown above.
- Step 2: The right angle is established by measuring a triangle with side lengths of 3m, 4m and 5m as illustrated in the Figure 6-8 .
- Step 2: Measure the length AB of 4m along the defined centre line. Set pegs exactly at points A and B. Hold the zero point of the tape measure on the peg A.
- Step 3: A second person holds the 8m mark of the tape measure on peg B. A third person holds the tape measure at the 5m mark which will lead to point C when the tape measure is pulled tight.

Figure 6-8: Setting out a right angle

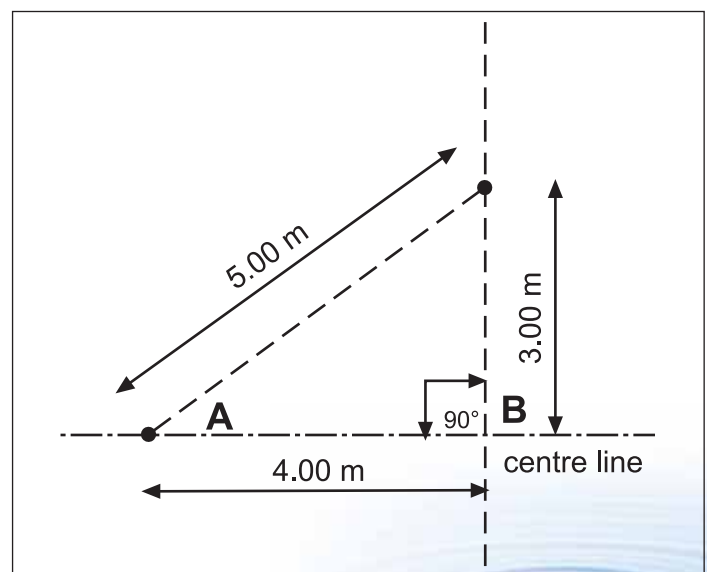



### 6.3.2 SETTING OUT A 45° ANGLE

- Step 1: First establish a right angle as shown above.
- Step 2: Set out the same distance on both of the two lines (L) starting from the intersection point B, e.g. 3m, and fix pegs A and C.
- Step 3: Span a string line between points A and C and measure this length A to C. Divide the length A to C by two and set peg D exactly in the middle of this length.
- Step 4: Establish the new line B to D with a string line and extend beyond peg D if necessary.

Figure 6-9: Setting out a 45° angle

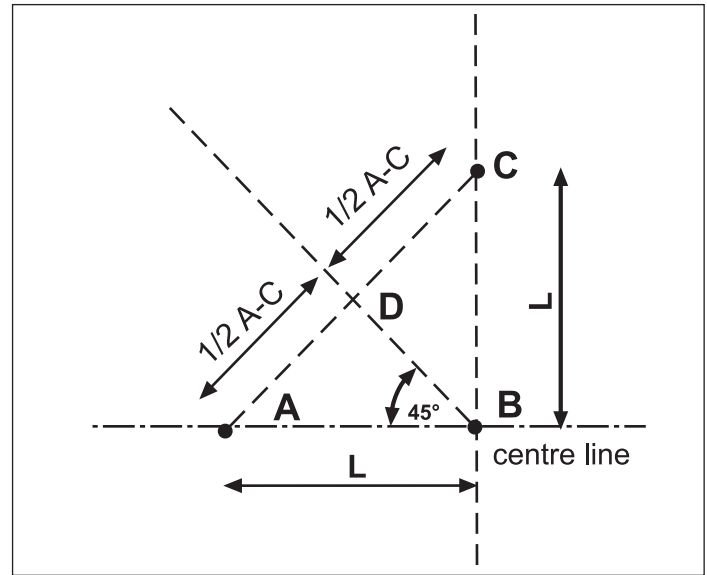

### 6.3.3 SETTING OUT 30° AND 60° ANGLES

- Step 1: First establish a right angle as shown above.
- Step 2: Set out the same distance (L) on both of the two lines starting from the intersection point B, e.g. 3m, and fix pegs A and C.
- Step 3: Span a string line between points A and C and measure this length A to C. Divide the length A to C by three and set pegs D (for 30°) after one third of the length A to C, or E (for 60°) after two thirds of the length A to C.
- Step 4: Establish the new lines B to D or B to E with a string line and extend beyond peg D or E if necessary.

Figure 6-10: Setting out 30° and 60°

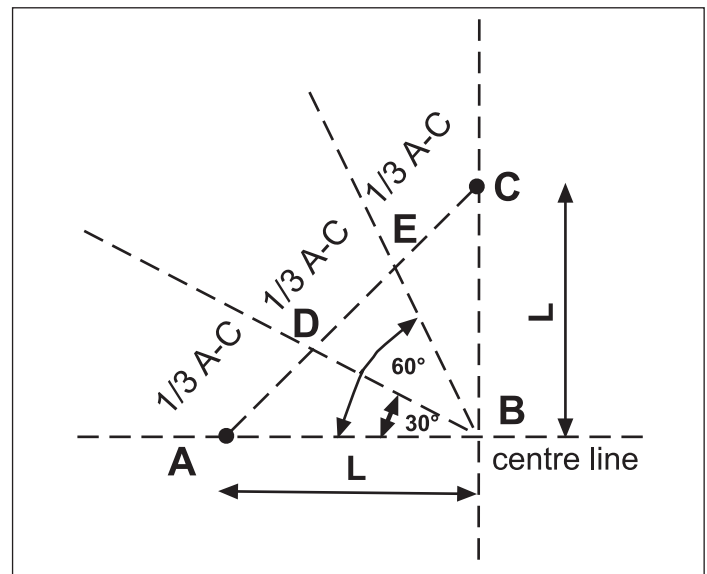

## 6.4 SETTING OUR GRADIENTS

### 6.4.1 CHECKING OR CONFIRMING AN EXISTING GRADIENT

- Step 1: Fix ranging rods vertically at the two end points of the slope firmly into the ground.
- Step 2: Tie the string line at the 1 metre mark<sup>10</sup> of the ranging rod at the higher point of the slope.
- Step 3: Whilst holding the string line at the lower ranging rod, hook the line level at the middle point between the two ranging rods.
- Step 4: Move the string line at the lower point ranging rod up or down until the level bubble is exactly in the middle. Mark this level at the lower ranging rod, turn the line level around and mark the level again. Measure the middle of the difference of the two marks – this is the exact horizontal level transferred from the higher to the lower ranging rod.

<sup>10</sup> On very steep slopes this 1m height may have to be adjusted as necessary.

Step 5: Measure the difference between your horizontal level mark and the one metre mark at the ranging rod (= D).

Step 6: Measure the exact distance (length) between the two ranging rods (= L)<sup>11</sup>.

Step 7: Calculate the gradient (percentage) of the slope. The calculation is as follows:

$$\frac{D}{L} \times 100 = \text{Slope \%}$$

Use centimetres for all measurements.

Figure 6-11: Confirming Gradients

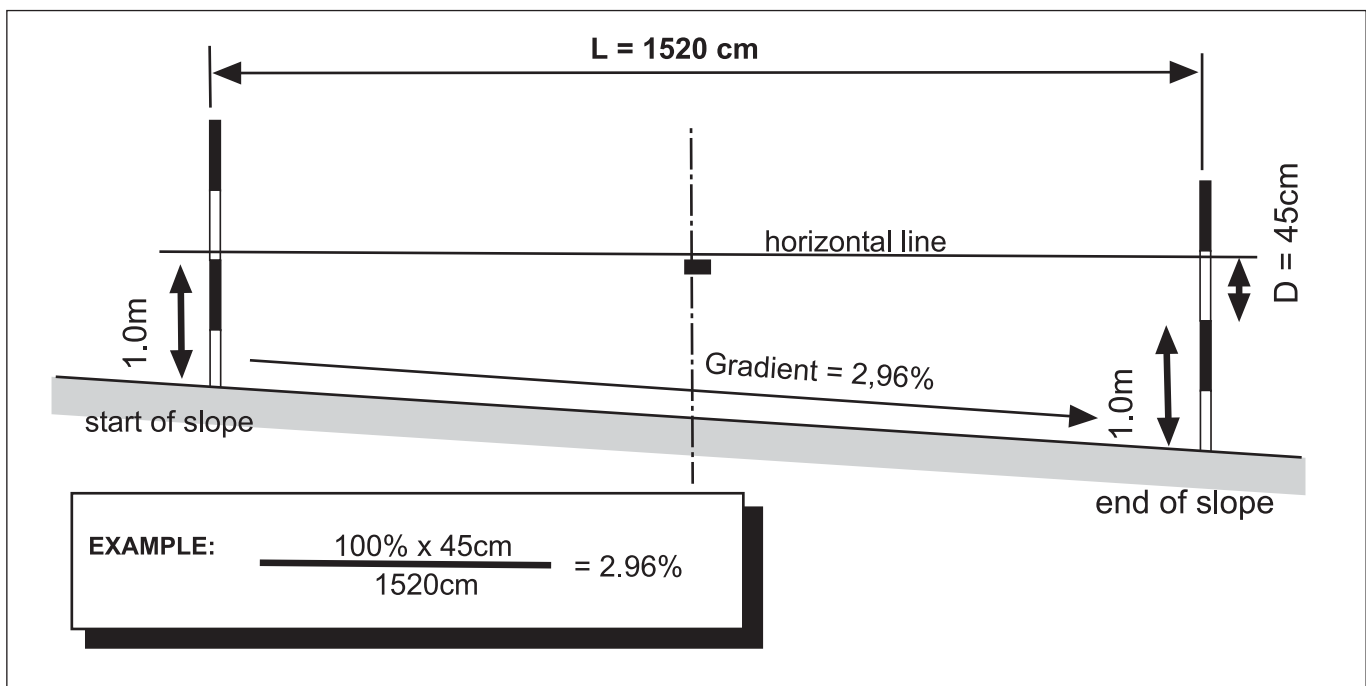

In general if the height on the upper ranging rod is “a” from the ground and that on the lower ranging rod is “b” after line level bubble is centred. Then the gradient (G) is given by:

$$G = \frac{(b - a)}{L} \times 100\%$$

### 6.4.2 SETTING OUT A DESIGN GRADIENT

The following are steps involved in setting out gradients:

- Step 1: Define level difference D by dividing L by 100% and multiply by given gradient G in % (e.g. 3% as in the example below)
- Step 2: Fix the string line to the lower ranging rod so that the line is horizontal and mark the point on the other ranging rod.
- Step 3: Now add D to 1 metre and measure from the level mark downwards. You will see that in order to be able to measure this new height, you need to dig a small slot next to the ranging rod. Dig the slot in small steps until you can measure the exact height (D + 1) metres. The bottom of this slot is now at the required level.

<sup>11</sup> Where feasible, use lengths (L) in multiples of 10 metres for ease of calculation.



Step 4: In order to transfer the gradient uniformly you have to use boning rods or profile boards. Set a boning rod at each end point, for every few metres dig a small slot, set the third boning rod (traveller) at the bottom of the slot and deepen or raise the slot until all three boning rods are in line with one another.

Figure 6-12: Setting out Gradient

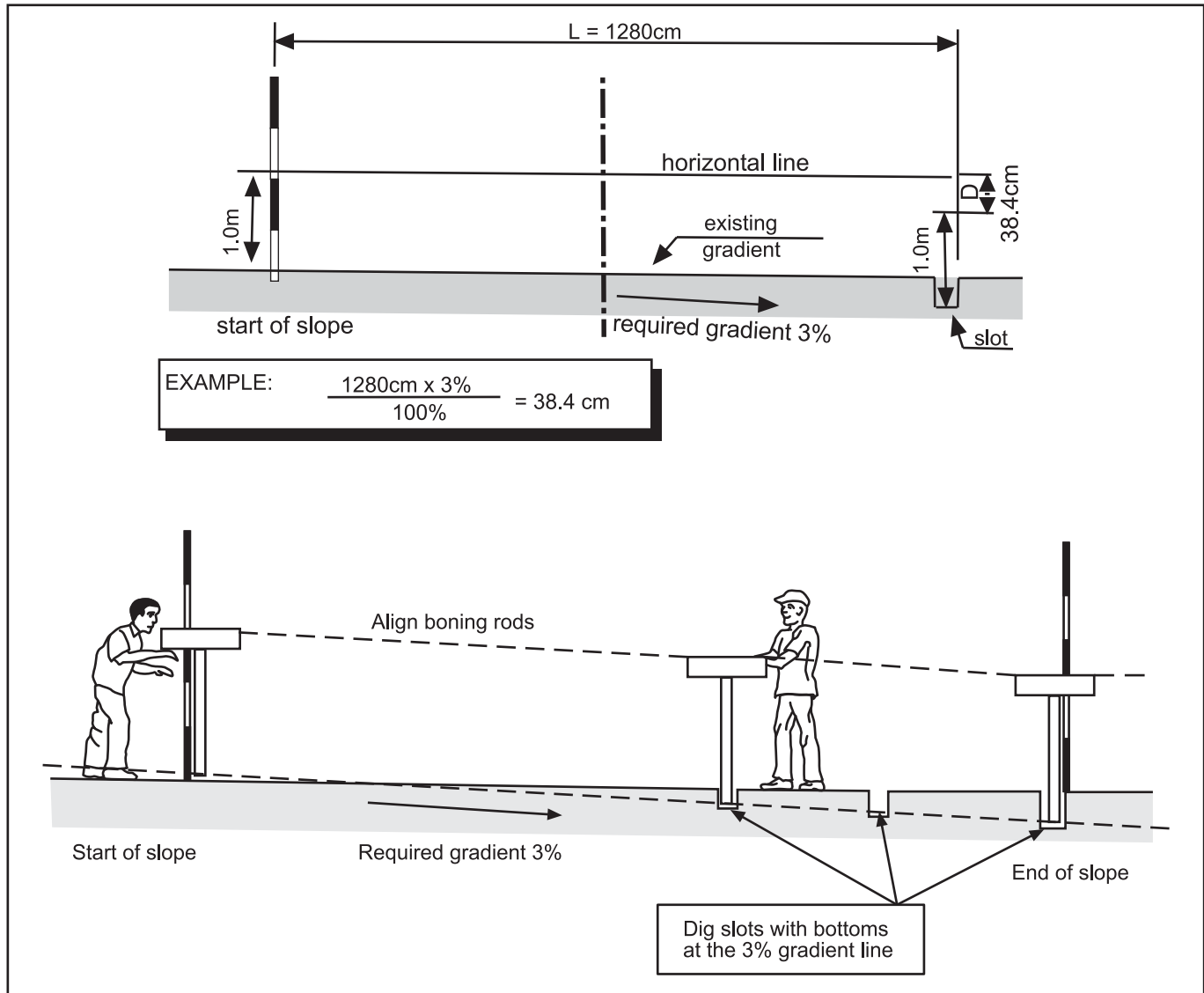

### 6.4.3 CHECKING THE UNIFORMITY OF A GRADIENT

In order to achieve a reasonably smooth and aligned surface (horizontal or gradient) without unnecessary depressions or humps it is necessary to control the levels. The simplest method is to use a set of boning rods and travellers. The procedure is as follows:

- Step 1: Fix boning rods or ranging rods with profile boards at the two ends of the straight line that has to be checked, ensuring the two points have the correct levels. If profile boards are used, make sure the two end boards are fixed at the identical measure on the rod, e.g. 1.30 metres from the ground.
- Step 2: While sighting from one end to the other, let an assistant place the third boning rod or profile board at any point you want to check in between the two end rods, e.g. the first rod is at the upstream manhole invert, the second placed at the invert of the downstream manhole and third is used to check whether the gradient between the two manholes is uniform.

Figure 6-13: Checking the uniformity of a gradient

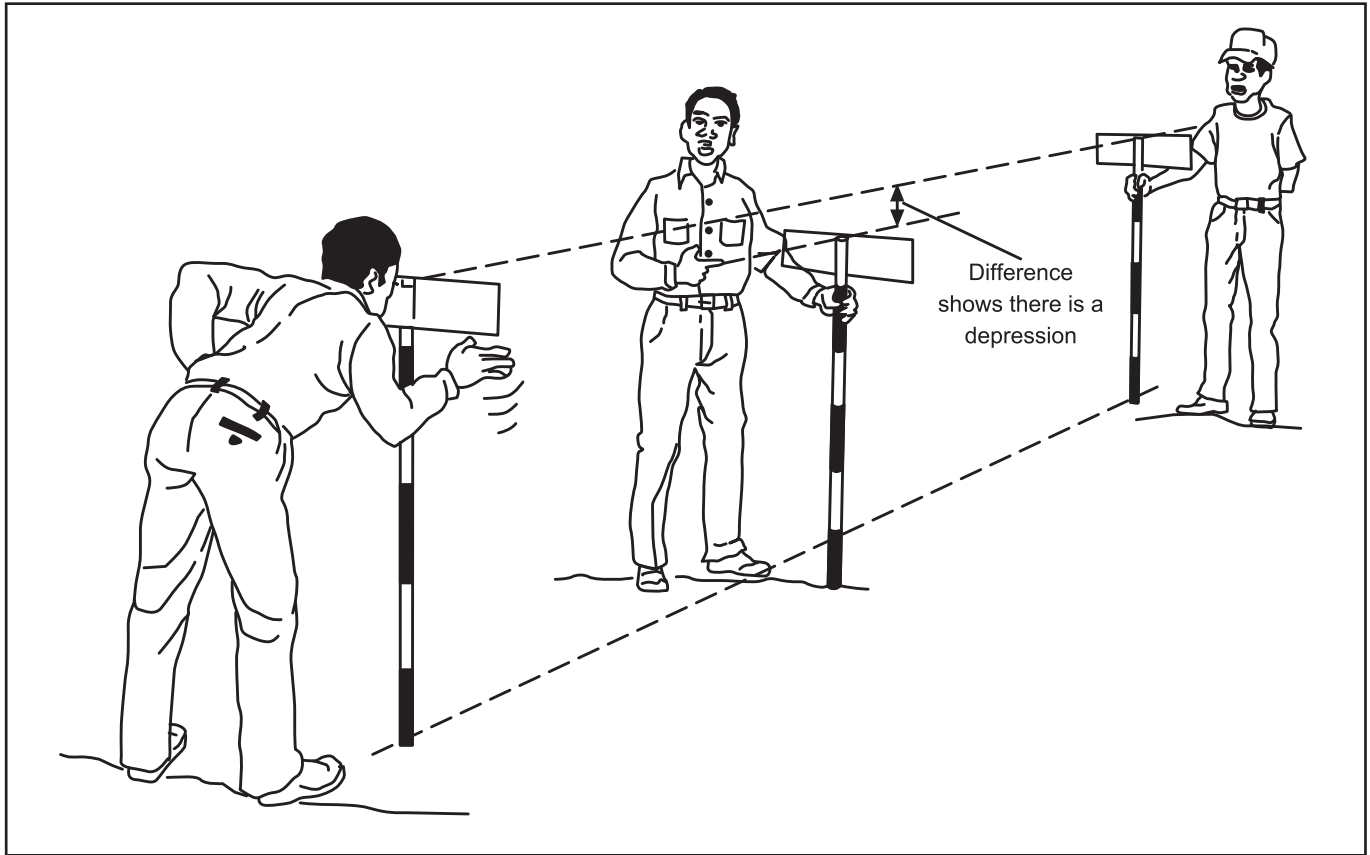





## 7. SITE CLEARANCE AND EARTH WORKS

This chapter focuses on site clearance and earthworks associated mainly with water, sanitation and building works.

These projects specifically include inter-alia, the construction of Dams, Bulk water transfer systems, Water Treatment Works, Storage Reservoirs, water reticulation networks, wastewater collection systems, wastewater treatment works, landscaping, foundations, and excavations amongst others. All these works involve various levels of site clearance and Earthworks. These operations can be undertaken using employment intensive techniques provided the quantities involved are not too large and the site conditions are favourable for use of manual labour. The following should be considered before adopting employment techniques:

- The hardness of the material to be excavated vis-à-vis the available hand tools
- The volume of material and the duration of the project to ascertain whether labour can be employed efficiently
- Haulage distances envisaged

The bulk of the potential temporary jobs to be created in these projects are usually in Earthworks. Bulk and Trench earthworks if properly planned may markedly reduce the need for heavy plant in favour of employment intensive approaches. Many workers normally get discouraged from undertaking earthworks, chiefly because of being overworked or being given unreasonable tasks. It is therefore critical in earthworks that fair tasks be set for workers to avoid exploitation and to ensure they do not develop negative attitudes towards labour based works.

### 7.1 SITE CLEARANCE

Clearing normally involves the cutting of grass/vegetation, digging up and removal of rubbish, debris, vegetation, hedges, shrubs and small trees of girth of up to 200mm, bushes including the digging up of top soil and examining for and removal of all roots and other organic matter likely to provide food for termites. The amount of vegetative cover can differ considerably, from semi-arid areas where the clearing work is negligible, to dense forests where power tools may be necessary to remove extensive tree roots. Removal of boulders and other obstructions are also part of clearance. Redundant buildings may also need to be demolished and moved.

In labour based works this activity is broken into sub activities namely bush clearance, grubbing, tree and stump removal for ease of work organization and resource management. In this case grubbing refers to the process of removing and disposing of roots, stumps (de-stumping), stubs, transverse roots and associated debris.

All clearing and grubbing work can be undertaken by hand with appropriate tools. However, if massive areas of several hectares have to be cleared it may be economical to engage mechanical equipment preferably in combination with labour.

Clearing sub-activities should be organized using individual or group tasks. The following are examples of task rates for clearing and grubbing activities. It should be noted that task rates for most of clearing activities are dependent on the type of vegetation and ease of removal.

**Table 7-1: Productivities for clearing and grubbing**

Activity	Description	Optimum Production
Bush clearing	Light bush (using slasher)	250 - 350 m <sup>2</sup> /wd
	Medium bush (using bush knife or bow saw)	150 - 250 m <sup>2</sup> /wd
	Dense bush (bow saw and axe)	100 - 150 m <sup>2</sup> /wd
Grass clearing	Removal of vegetation to ground surface	350 -750 m <sup>2</sup> /wd
Destumping	Removal of tree stumps with major roots	Dayworks
Grubbing	Root removal to 250 mm depth in soft loamy soil	60 - 175 m <sup>2</sup> /wd
Boulder and obstruction removal	Removal of loose debris, boulders and other obstructions (fallen trees, dead animals etc.)	Dayworks



Figure 7-1: Site Clearing by Employment Intensive Construction



Boulder removal activity involves the removal of large stones or boulders and their disposal at suitable and approved locations. There are various methods that can be employed to carry out this activity. They may be used separately or in combination. The method to be used shall depend on the size, shape and position of the boulder and on which tools and equipment are available.

However, irrespective of the method used, rock must be disposed of at appropriate locations outside the cleared width where the next construction activity is to take place.

Boulders may be carried, rolled, towed or pushed in the following ways:

- physical lifting of boulders by workers and dumping them outside the cleared width,
- workers rolling boulders outside the cleared width with the aid of crow bars,
- workers towing boulders outside the cleared width with the aid of ropes
- tractor towing boulders outside the cleared width with the aid of ropes

The first 3 methods above are suitable for boulders of less than 0.5m<sup>3</sup> in volume.

An individual boulder or rock surface may be cracked by building a substantial fire around and/or over it to heat it and rapidly cooling it with water.

The vegetation arising from other clearance activities may be used for firewood in this activity. The fire will need to be fuelled for a long period (at least 6 hours) to heat up and expand the rock sufficiently. This heating stage can also be done overnight to save on time. The boulder should then be cooled rapidly by dousing it with large volumes of water. The rapid cooling will cause shrinkage and cracking of the rock. Cracking may also be encouraged by striking the boulder with sledgehammers at this stage. The rock can then be split into pieces using chisels and sledgehammers along the cracks. Depending on the size

Figure 7-2: Boulder removal with feather and wedges

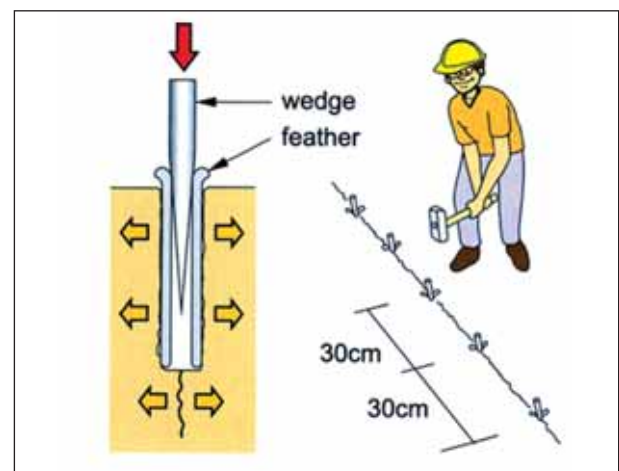

and type of rock, the process of heating, cooling and cracking may have to be repeated a number of times before the resultant pieces are manageable.

If the boulder or rock is weathered or cracked it is often possible to break it into smaller pieces using picks, sledge hammers with chisels and wedges or feathers and plugs. Feathers and plugs can be used in groups of four to break rock along a pre-determined line. Holes can be drilled in rock using hand quarry drills and sledge hammers. These feathers and plugs are then used as the splitting tools.

Boulders may also be split using a jack hammer if the quantities of rock are large. The jack hammer uses compressed air from a compressor to break the rocks by striking them repeatedly. Since the jack hammer breaks rocks at a relatively fast rate, it is important to remove the split rocks as quickly as possible from the working area by having adequate labourers to clear the rocks.

It is impossible to use Task System on boulder removals and therefore workers should be assigned on day work system.

## 7.2 EARTHWORKS

If properly organized with the aid of level control equipment and aids such as slots, profile boards, boning rods amongst other, earthworks can be undertaken to the required quality and speed. To prevent long haulage of excavated in situ or borrowed materials it is recommended that cuts and fills in earthworks are balanced transversely thus limiting haulage to the use of wheel barrows and light transportation equipment.

### 7.2.1 EXCAVATION OF TRENCHES

Generally trenches up to a maximum depth of 1.5m can be excavated by hand without need for shoring. However, in certain difficult geological formations, the Engineer may instruct the Contractor to shore or secure the trench as necessary. It is important that tasks are set fairly so as to encourage work in this activity. Unfairly set tasks tend to discourage workers leading to a general bad attitude by workers to labour-based work.

Soil types are generally classified as loose or dense depending on the difficult/ease of their excavation. Different countries or institutions use various classifications. These classifications are often used to set out correct task and eliminate ambiguities during implementation. An example from South Africa is given in Table 7-2 below.

**Table 7-2: Classification of In-situ Materials**

GRANULAR MATERIALS		COHESIVE MATERIALS	
CONSISTENCY	DESCRIPTION	CONSISTENCY	DESCRIPTION
<b>Very Loose</b>	Crumbles very easily when scraped with a geological pick.	<b>Very Soft</b>	Geological pick head can easily be pushed in as far as the shaft of the handle.
<b>Loose</b>	Small resistance to penetration by sharp end of a geological pick.	<b>Soft</b>	Easily dented by thumb; sharp end of a geological pick can be pushed in 30~40 mm; can be moulded by fingers with some pressure.
<b>Medium Dense</b>	Considerable resistance to penetration by sharp end of a geological pick.	<b>Firm</b>	Indented by thumb with effort; sharp end of geological pick can be pushed in up to 10mm; very difficult to mould with fingers; can just be penetrated with an ordinary hand spade.
<b>Dense</b>	Very high resistance to penetration by the sharp end of geological pick; requires many blows for excavation.	<b>Stiff</b>	Can be indented by thumbnail; slight indentation produced by pushing geological pick point into soil; cannot be moulded by fingers.
<b>Very Dense</b>	High resistance to repeated blows of a geological pick.	<b>Very Stiff</b>	Indented by thumbnail with difficulty; slight indentation produced by blow of a geological pick point.

Source: CIDB



A World Bank study produced a comprehensive definition based on soil type and tool penetration. This is summarized below in Table 7-3 below which can assist Project Managers on a case by case basis.

**Table 7-3: Soil Excavation Characteristics**

Activity Definition	Soil Description		Suitable Tools
	Cohesive	Non-cohesive	
<b>Soft</b>	Soft	Very loose	Easily excavated with a shovel or hoe
<b>Medium</b>	Firm	Loose	Can be dug with a shovel
<b>Hard</b>	Stiff	Compact	Mattock, pick or other swung tool required
<b>Very hard</b>	Very stiff or hard	Dense or very dense	Crowbar required in addition to pick
<b>Rock</b>	Rock		Sledge hammer and chisels required

Source: World Bank

**Table 7-4: Productivity for excavation**

Activity	Task Rate
Excavation in earth not exceeding 2m deep Trenches	3.0 m <sup>3</sup> /wd
Extra over trench and hole excavations in earth for excavation in:	
Soft rock	1.5m <sup>3</sup> /wd
Hard rock	0.5m <sup>3</sup> /wd
Extra over all excavations for carting away surplus material from excavations and/or stockpiles on site to a dumping site to a maximum of 100m using wheel barrow	3.0 m <sup>3</sup> /wd
Shoring side trenches for risk of collapse of excavations	20m <sup>2</sup> /wd

Source: CIDB

### 7.3 FILLS

This method is employed where it is necessary to raise the ground level for example across low-lying land with poor drainage, when terracing steep slopes in line with architectural requirements or as necessary as per the Project Supervisor’s instruction. The method described herein is for bulk fills similar to those encountered in building construction or similar developments.

Initially, an estimate of the width of the cleared activities must be made to ensure that the cleared area is adequate to construct the embankment. A suitable fill work method is described in Box 7-1 below and Table 7-5 below provides the task rate for earth filling activity.

**Box 7-1: Fill Construction Work Method**

It is necessary to set out the toe of the embankment and, as the fill rises, the toe of the shoulder. Pegs should be established for these points.

When the toe position T is determined, a peg should be installed. A batter profile of 1:1 should also be erected to guide the earthworks fill.

In general, fill material shall be graded granular soil free of stumps, trees, rubbish and other deleterious material and approved by the Engineer. The Contractor shall allow in the tender for the cost of laboratory tests to determine the optimum moisture content and dry density of the fill material prior to the commencement of filling operations. Fill materials shall generally be placed in layers not exceeding 300mm thick per layer, and uniformly compacted to the satisfaction of the Engineer before the next layer is applied. In confined work spaces, the use of approved type of hand or mechanical rammers or compressed air compactors will be permitted.

Compaction of fill shall be controlled and carried out with sufficient passes of the mechanical rammers to obtain at least 90% of the maximum dry density at optimum moisture content compared with standard Proctor laboratory test results or as specified. The Contractor shall when directed by the Engineer carry out compliance field tests to check the degree of compaction attained on Site. Only tests that meet the minimum compaction requirements of this specification will be paid. The Contractor shall have no claim for extra time in connection therewith.

Compaction shall not be carried out when the fill is too dry to achieve the satisfactory degree of compaction. In the case of dry fill, the moisture content shall be increased by spraying with water from travelling water tanks or by other approved means as the compaction proceeds.

Where the Contractor has failed to obtain sufficient compaction in each layer to the satisfaction of the Engineer, he shall not be allowed to proceed with the next layer without the Engineer’s approval, and no claim for time lost or extra time required will be allowed in connection therewith.

Where undue movement occurs in the course of compaction due to soft, unstable foundation conditions under the fill, the area affected shall be excavated to such depths and over such dimensions as the Engineer will direct and be run to spoil. The resultant excavation shall be backfilled with suitable and approved materials deposited in layers, each not exceeding 300mm thick in loose form, and compacted as hereinbefore specified, or with suitable compressed air compactors or hand or mechanical rammers where the excavation work is limited. The Contractor shall have no claim on time or cost in connection therewith.

Fill batter faces should be compacted as a separate operation, or alternatively, overfilled and cut back.

Environment, health and safety procedures should include the following:

- Where any side-borrow has been made outside the formation width, it must be rehabilitated to discourage ponding of water and/or possible erosion.
- At any excavation face the use of heavy tools combined with the threat of falling material constitutes a risk situation and labourers must be well-spaced to avoid injury.
- In extremely dry areas, dust reduction measures (e.g. dampening the soil with water) must be considered if unhealthy levels of dust are suspected.
- A first aid kit must be readily available on site for any emergency.

**Table 7-5: Productivity for earth filling**

Activity	Task Rate
Earth filling: Over site; under floors; backfilling to trenches, holes, etc.	5m <sup>3</sup> /wd

Source: CIDB

## 7.4 HAULING

Hauling by labour has been proved to be cost-effective for distances of up to 150 metres using wheelbarrows. Table 7-6 gives recommended productivity when using suitable wheelbarrows. For greater distances, use of suitable local transportation such as animal drawn carts, tractors/trailer combination or other capital equipment becomes necessary.

Productivity is very dependent on the condition of the haul route and the terrain through which the material must be moved and the organization of the work force. For efficient haulages the wheelbarrows should be maintained in good operational condition.



**Table 7-6: Wheelbarrow Haulage Productivity Norm**

Hauling Distance Range	Productivity Rates
0 ~ 20 metres	8.5 m <sup>3</sup> /wd
20 ~ 40 metres	7.0 m <sup>3</sup> /wd
40 ~ 60 metres	6.5 m <sup>3</sup> /wd
60 ~ 80 metres	5.5 m <sup>3</sup> /wd
80 ~ 100 metres	5.0 m <sup>3</sup> /wd
100 ~ 150 metres	4.0 m <sup>3</sup> /wd

Source: ILO

Equipment haulage is typically carried out by a tractor/trailer<sup>12</sup> combination for distances up to five kilometres, with trucks being used thereafter. However, this is a rough guideline and needs to be tested for individual circumstances. For example in some countries Tipper trucks are readily available thus use of tractors may be limited to remote rural areas or minor works. Experience has shown that the optimum capacity for trailers is 3m<sup>3</sup>. On the other hand trucks should not be too large or too high or else they will be difficult to load by hand and manoeuvre on a labour-based site. Tipping trucks with a capacity of 5m<sup>3</sup> to 7m<sup>3</sup> have therefore proved ideal for labour based situations. Table 7-7 gives recommended productivities for various manually loaded equipment.

**Table 7-7: Typical Haulage Rates for Manual Loaded Equipment**

Equipment Used	Route Condition and Haul Distance (km)														
	Good					Average					Poor				
	2	4	6	8	10	2	4	6	8	10	2	4	6	8	10
Trips per day per truck	22	19	16	11	8	18	15	12	8	6	16	12	10	7	5
Trips per day per tractor/ one-trailer combination	20	12	8	6	4	14	11	6	5	4	16	9	4	4	3
Trips per day per tractor/ two-trailer combination	17	10	7	5	4	17	10	5	5	4	15	8	4	4	3

**Assumptions:**  
 Tipper loading capacity = 5m<sup>3</sup>/trip Tractor trailer capacity = 3m<sup>3</sup>/trip  
 Tipper travelling at: 55/60 km/h on good route; 45/50 km/h on average route; 35/40 km/h on poor route (loaded/empty)  
 Tractor travelling at: 35/40 km/h on good route; 25/30 km/h on average route; 15/20 km/h on poor route (loaded/empty)

## 7.5 LOADING, UNLOADING AND SPREADING

These activities are either done independently, or in some cases, combined with others into a single activity. Loading is often part of the excavation activity where no double handling of the material is involved, and loading heights of less than one metre are common.

### 7.5.1 LOADING

Loading refers to loading from a pre-excavated stockpile, and can be applied to any material. However, it must be remembered that if material is left to stand for a considerable period and subjected to wetting and drying, it will need to be re-loosened, which constitutes a new excavation task. Loading heights of more than one metre are very difficult by manual methods, and loading bays should be fashioned to avoid this problem. Loading is measured in loose cubic metres of material.

<sup>12</sup> Experience has shown that a combination of one tractor with two trailers is more economical and efficient for haulage of material.

### 7.5.2 UNLOADING

Unloading is probably unique to labour-based activities in civil engineering. It does not refer to wheelbarrows, but to emptying non-tipping trailers or trucks. Because of many problems experienced with small hydraulically operated tipping trailers, many projects have found it preferable to develop specially shaped rigid trailers or flatbed trucks which can be relatively easily emptied by hand. The productivity rates given relate mainly to 3m<sup>3</sup> trailers with or without special side doors. However, they are equally applicable to flat trucks or larger trailers if they are properly designed. Unloading is measured in loose cubic metres of material.

### 7.5.3 SPREADING

This refers to the general activity of converting loosely dumped soil or gravel into a smooth and even surface to the required thickness. It includes moving material by shovel, hoe, rake, and the use of levelling devices as necessary and string lines. Spreading can be measured in loose cubic metres or square metres of material for a given thickness. The following table provides task rates for manual loading, unloading and spreading of fill material.

**Table 7-8: Loading, Unloading and Spreading Productivity Norms**

	Average productivity rates		
	Loading	Unloading	Spreading
Recommended value	8.5m <sup>3</sup> /wd	10m <sup>3</sup> /wd	13.5m <sup>3</sup> /wd

Source: ILO

## 7.6 PIPE LAYING AND BEDDING

This activity is actually a combination of several activities, namely:

1) is transportation of the pipe to site, unloading usually at the Site stores, 2) transporting to and placing adjacent to trench, 3) lowering into the trench, jointing and 4) testing. Please note that in a typical Bill of Quantities all these activities may be grouped as one bill item and hence adequate provision must be made during building up of rates and resource allocation. Pipe bedding involves placing, spreading to a specified thickness and compaction of bedding and selected fill material in the confines of a trench. For small pipes, pipe bedding takes the bulk of the time whilst in larger heavier pipes the handling of pipes takes more time especially in rigid pipes. Productivity data on the laying and bedding of concrete pipe culverts is readily available but very limited studies on laying of water/sewer pipes have been done. The productivity rates for bedding in this guideline is adapted from spreading and compaction task rates with due consideration of the difficulties of working in the confines of trenches as well as taking care not to damage the laid UPVC pipes.

Table 7-9 below suggests productivity rates for laying of UPVC pipes based on available spreading and concrete pipe culvert laying productivity rates. As these rates are based on empirical projections from the road sector they are still largely anecdotal and they should be used with care. More work studies in this area need to be done.

**Table 7-9: PVC Pipe Laying and Bedding Productivity**

Pipe Diameter	Productivity in metres per workerday		
	Bedding Only	Pipe Laying and Bedding	Pipe Laying Only
110 mm	3.0m/wd	2.8m/wd	56m/wd
160 mm	2.9m/wd	2.7 m/wd	54m/wd
200 mm	2.8m/wd	2.5 m/wd	25m/wd
250 mm	2.7m/wd	2.4 m/wd	19m/wd
315 mm	2.6m/wd	2.3 m/wd	18m/wd
355 mm	2.5m/wd	2.2 m/wd	14m/wd
400 mm	2.5m/wd	2.1 m/wd	13m/wd





### 7.7 TRENCH BACKFILLING

The process of trench backfilling involves placing of material in specified layer thickness and compacting to specification. By reducing spreading and compaction productivities by 25% we recommend a productivity rate of 4m<sup>3</sup>/wd for general backfilling.

Box 7-2 below illustrates the proper processes of pipe bedding and trench backfilling.

#### Box 7-2: Pipe Bedding and Backfilling

<ul style="list-style-type: none"> <li>The material for backfilling must not contain lumps, rocks or large stones as per specification. The "Selected Granular (bedding) Material" shall be of a granular, non-cohesive nature that is singularly graded between 0.6mm to 19mm, is free draining, and has a compactibility factor not exceeding 0.4. The pipe must first be covered with 100mm of this material and a further 200mm of selected fill material before general backfilling of the remaining trench can be permitted. The Selected Fill Material" shall have a Plasticity Index not exceeding 6 and that is free from vegetation and from lumps or stone of diameter exceeding 30mm.</li> <li>The initial backfilling (300mm above pipe) should be undertaken as soon as possible to protect the pipe.</li> </ul>	
<ul style="list-style-type: none"> <li>Selected Granular Material or sand shall be placed up to a height of 1/2 of the external diameter.</li> <li>The soil under the pipe and between the pipeline and trench wall shall be tamped to specification.</li> </ul>	
<ul style="list-style-type: none"> <li>Backfill and tamp every 100 mm layer by hand to a height of 300mm over the pipe.</li> </ul>	
<ul style="list-style-type: none"> <li>Bulk-backfill of the rest of the trench in layers not exceeding 300 mm (when compacted to 90% Mod AASHTO) where there is no traffic load and 150mm (when compacted to 93% Mod AASHTO in cohesive soil or to 98% Mod AASHTO in non-cohesive soil) where there is traffic loading.</li> </ul>	

#### 7.7.1 BULKING AND SHRINKAGE

Excavation increases the volume of material that is excavated. It is therefore necessary to use a bulking factor to determine the volume of material that will be created by excavation. Bulking factor is defined as:

$$\text{Bulking Factor} = \frac{\text{Volume after Excavation}}{\text{Volume before Excavation}}$$

Similarly a shrinkage factor is defined for the compaction of a soil at its final destination:

$$\text{Shrinkage Factor} = \frac{\text{Volume after Compaction}}{\text{Volume before Compaction}}$$

Table below gives a guide to bulking and shrinkage factors for different soil types.

**Table 7-10: Bulking and Shrinkage Factors**

Material	Bulk Density	Bulking Factor	Shrinkage Factor
Clay (Low PI)	1,650kg/m <sup>3</sup>	1.30	-
Clay (High PI)	2,100 kg/m <sup>3</sup>	1.40	0.90
Clay and Gravel	1,800 kg/m <sup>3</sup>	1.35	-
Sand	2,000 kg/m <sup>3</sup>	1.05	0.89
Sand & Gravel	1,950 kg/m <sup>3</sup>	1.15	-
Gravel	2,100 kg/m <sup>3</sup>	1.05	0.97
Chalk	1,850 kg/m <sup>3</sup>	1.50	0.97
Shales	2,350 kg/m <sup>3</sup>	1.50	1.33
Limestone	2,600 kg/m <sup>3</sup>	1.63	1.36
Sandstone (Porous)	2,500 kg/m <sup>3</sup>	1.60	-
Sandstone (Cemented)	2,650 kg/m <sup>3</sup>	1.61	1.34
Basalt	2,950 kg/m <sup>3</sup>	1.64	1.36
Granite	2,410 kg/m <sup>3</sup>	1.72	1.33

## 7.8 HARD ROCK REMOVAL: BLASTING EQUIPMENT AND PROCEDURES

If extensive deposits of hard sound rock are encountered in a project site, use of LIC rock removal techniques discussed earlier in this chapter may prove uneconomic and technical not feasible. If conventional rock breaking and removal is also uneconomic blasting may be opted for. In a Labour based project safety is even much more important and procedures should thus ensure maximum protection of life and property.

### 7.8.1 COMPETENCE OF WORKERS

You should ensure that all Personnel employed to handle explosive are competent to do so and should have the necessary Licences as required by law.

### 7.8.2 STORAGE OF EXPLOSIVES

If explosive have to be stored on site all care should be taken as stipulated in the relevant Occupational Health and Safety Act: Explosives Regulations. The magazine should be located at a safe distance as stipulated in the regulations from all developments. As necessary all safety procedures such as earth mounds around the magazine should be constructed. The storage area should be fenced and under guard and only authorized personnel should be permitted to the area.

### 7.8.3 BLASTING OPERATIONS

All the necessary permits should be sought before blasting operations commence. Local Authorities and the Police should also be informed so that they issue the necessary permits.



All care should be taken to ensure that the area being blasted is vacated and all workers are accounted for at a safe distance. All gang leaders should take roll calls and account for their gang members. When blasting near built up areas communities should be informed of such operations and as necessary they should vacate the area for safety reasons. Buildings should be inspected before and after blasting so as to avoid disputes with regards to any damages that may occur. Authorised personnel should first inspect the blast zone after blasting to ensure that there are no undetonated explosives.

## 7.9 LANDSCAPING OPERATIONS

Landscaping refers to any activity that alters the visible features of a piece of land, including but not limited to plants, animals, soil appearance, elevation, landforms, terrain shape, bodies of water and the like. Gardening is an operation of landscaping and is the art and skill of growing plants with a goal of creating a beautiful environment within the landscape.

Landscaping operations can be undertaken by labour, hand tools and light machinery. There are limited productivity rates for landscaping activities. It is therefore important to carryout work studies in order to determine suitable productivity rates. The following are indicative productivity rates adapted from a previous study.

**Table 7-11: Landscaping Interim Productivity Rates**

Activity	Productivity	Units
<b>Grass Slashing</b>		
Dense bush	750	m <sup>2</sup> /wd
Medium bush	1,125	m <sup>2</sup> /wd
Light bush	1,350	m <sup>2</sup> /wd
<b>De-weeding and Flower Cultivation</b>		
Densely planted	375	m <sup>2</sup> /wd
Medium planted	250	m <sup>2</sup> /wd
Lightly planted	175	m <sup>2</sup> /wd
<b>Trimming of Lawn Edges with hand shears</b>	30	m/wd
<b>Grass Planting in prepared Beds with rows 300mm apart</b>	75	m <sup>2</sup> /wd
<b>Hedge Trimming with hand shears including clearing</b>		
Dense conditions	90	m <sup>2</sup> /wd
Medium conditions	135	m <sup>2</sup> /wd
Light conditions	160	m <sup>2</sup> /wd
<b>Path Sweeping</b>	1,000	m <sup>2</sup> /wd
<b>Cultivation using garden fork</b>	130	m <sup>2</sup> /wd

Source: City of Bulawayo, 1979

### Trench Excavation Task Rates

Trench excavation is unique in that CIDB also suggest the following task rates.

**Table 7-12: Trench excavation task rates, measured in place**

Excavation	Tools	Tasks in m <sup>3</sup> /workerday for Throwing Distance of	
		Up to 4 m	4 to 6 m
Loose soil	Shovel	5.0 to 6.0 m <sup>3</sup> /wd	4.5 to 5.0 m <sup>3</sup> /wd
Sticky soil	Spade, fork, forked hoe	2.0 to 3.0 m <sup>3</sup> /wd	1.5 to 2.0 m <sup>3</sup> /wd
Firm soil	Pick, shovel, spade, hoe	3.0 to 4.5 m <sup>3</sup> /wd	2.5 to 4.0 m <sup>3</sup> /wd
Hard stony gravel	Pick, shovel, crowbar	1.5 to 2.0 m <sup>3</sup> /wd	1.0 to 1.5 m <sup>3</sup> /wd

Source: CIDB

The ILO recommends the following task rates.

**Table 7-13: Excavation Norms**

Description	Productivity by Soil Classification	Remarks
Soft	5.0m <sup>3</sup> per worker day	Reduce by 10% for trenches deeper than 1.0m but equal or less than 1.5m. Trenches deeper than 1.5m can be excavated by hand up to 1.5m and the remaining by other means with special consideration to workers safety
Medium	3.5m <sup>3</sup> per worker day	
Hard	3.0m <sup>3</sup> per worker day	
Very hard	2.0m <sup>3</sup> per worker day	
Rock	0.8m <sup>3</sup> per worker day	

Source: ILO

ILO recommends the following haulage productivity rates.

**Table 7-14: Wheelbarrow haulage norms**

Haul Distance Range	Productivity
0 – 20 metres	8.5m <sup>3</sup> /wd
20 – 40 metres	7.0m <sup>3</sup> /wd
40 – 60 metres	6.5m <sup>3</sup> /wd
60 – 80 metres	5.5m <sup>3</sup> /wd

Source: ILO



## 8. CONCRETE WORKS

### 8.1 CONCRETE PREAMBLE

Concrete is a construction material composed of cement (commonly Ordinary Portland cement) as well as other cementitious materials such as fly ash and slag cement, aggregate (generally a coarse aggregate such as gravel, limestone, or granite, plus a fine aggregate such as sand), water, and in some cases chemical admixtures. The word concrete comes from the Latin word “concretus”, which means “hardened” or “hard”.

Concrete solidifies and hardens after mixing with water and placement due to a chemical process known as hydration. The water reacts with the cement, which bonds the other components together, eventually creating a stone-like material. Concrete is used to make pavements, architectural structures, foundations, highways/roads, bridges/overpasses, parking structures, brick/block walls and footings for gates, fences and poles.

### 8.2 TYPES OF CONCRETE

There are many different types of concrete based on composition in relation to the intended use. The most commonly used in general civil engineering works are lean concrete, mass concrete, structural concrete, pre-stressed concrete and precast concrete.

Lean concrete is low cement concrete meant for non-structural use. It is mainly used for filling such as over excavations. Mass concrete is also known as unreinforced concrete and used for foundations including blinding, mass structures such as dams and Gravity retaining walls. Structural concrete is of relative high density consisting of stone aggregate and has high strength and usually reinforced and designed for load bearing purposes. Pre-stressed concrete is essentially structural concrete which is subjected to compression in those parts which in service are subjected to tensile forces so that generally, the concrete is nowhere in a state of tension under the working load. Precast concrete is that which is placed in separate moulds, under controlled factory conditions, to harden and when necessary it is transferred to site for final erection. This procedure allows high quality concrete castings to be made at low relative costs. This method is used for the production of paving slabs, bricks, road channels, kerbs, lintels, fence posts, bridge beams and the like. Precast units can include reinforcement and engineered steel inserts.

### 8.3 CONCRETE COMPOSITION

Concrete is normally composed of water, cement, sand and stone aggregate in specified proportion depending on the intended use and target quality.

#### 8.3.1 WATER

Water used for concrete should generally be free from oils, acids, alkalis and organic impurities. As a guide water fit for drinking can be used in concreting. However, when working in remote areas it may not be possible to get potable water for concreting and the Project Supervisor or Engineer may authorize use of water that is not potable. The following should be noted:

- Soft water produces weaker concrete than hard water<sup>13</sup>.
- Water from marshes are generally not suitable for concreting.
- Water containing decaying vegetables is undesired as this contamination interferes with cement setting.
- Sea water is not preferred for any concrete works, in particular reinforced concrete works. However, sea water may be used for mass concrete with approval from the Project Supervisor or Engineer. Sea water retards setting and hardening with coupled risk of efflorescence<sup>14</sup> but will generally not affect the ultimate strength of concrete unless excessive quantities of salt are present in the water. Excessive salts tend to corrode reinforcement.

<sup>13</sup> Soft water has hardness as CaCO<sub>3</sub> of less than 50 mg/l, Reasonably soft 50 to 100 mg/l, Slightly hard 100 to 150 mg/l, Reasonably hard 150 to 250 mg/l, Hard 250 to 350 mg/l, very hard More than 350 mg/l. Rain water is usually soft as it has very little opportunity to absorb chemicals.

<sup>14</sup> Efflorescence is the phenomenon when salts and other water dispersible materials come to the surface of concretes and mortars.



### 8.3.2 CEMENT

There are five main generic types of Cement. Most Building and Engineering works employ the use of Ordinary Portland Cement (OPC). In concrete works one should generally assume the use of OPC unless another type is specified. Not all these types are available in many countries due to technological and demand constraints. As a guide the following should be adhered to:

- Cement should be stored in a dry place protected from atmospheric elements on a wooden platform raised at least 150mm above the floor
- Avoiding stacking more than ten to twelve bags as bottom bags may burst. Generally bags should not be stacked to a height exceeding 4.5 metres
- Store the cement in close stacks to avoid air circulation and absorbance of moisture from the air
- Avoid storing cement for more than two months from the date of leaving the Manufacturer’s premises before usage
- Cement stored for more than two months should not be used for critical structural members. Cement stored for more than two months but less than six months may be used in some minor works with the Engineer’s approval. Cement stored for more than three months should be discarded or at least re-tested before any reuse is considered. As a general rule stocks first in must be used first.

Table 8-1 below shows the strength versus period of storage from date of leaving Manufacturer’s Factory.

**Table 8-1: Strength of Cement versus Shelf Life**

Period of Storage in Months	Strength as a Percentage of Specified Criteria
0 month	100%
3 months	80%
6 months	70%
12 months	60%
24 months	50%

Source: Indian Civil Engineer’s Practical Handbook

For example, Table 8-2 in the following page shows the types of cement permitted by SANS 50197-1 in South Africa.

Table 8-2: Different Type of Cements

Main Types	Notation of products (types of common cement)		Composition, percentage by mass(a)											
			Clinker	Blast-furnace slag	Silica fume	Pozzolana		Fly ash		Burnt shale	Limestone		Minor additional constituents	
			K	S	D <sup>(b)</sup>	P	Q	V	W	T	L	LL		
CEM I	Portland cement	CEM I	95 - 100	-	-	-	-	-	-	-	-	-	-	0 - 5
CEM II	Portland-slag cement	CEM II A-S	80 - 94	6 - 20	-	-	-	-	-	-	-	-	-	0 - 5
		CEM II B-S	65 - 79	21 - 35	-	-	-	-	-	-	-	-	-	0 - 5
	Portland-silica fume cement	CEM II A-D	90 - 94	-	6 - 10	-	-	-	-	-	-	-	-	0 - 5
	Portland-pozzolana cement	CEM II A-P	80 - 94	-	-	6 - 20	-	-	-	-	-	-	-	0 - 5
		CEM II B-P	65 - 79	-	-	21 - 35	-	-	-	-	-	-	-	0 - 5
		CEM II A-Q	80 - 94	-	-	-	6 - 20	-	-	-	-	-	-	0 - 5
		CEM II B-Q	65 - 79	-	-	-	21 - 35	-	-	-	-	-	-	0 - 5
	Portland-fly ash cement	CEM II A-V	80 - 94	-	-	-	-	6 - 20	-	-	-	-	-	0 - 5
		CEM II B-V	65 - 79	-	-	-	-	21 - 35	-	-	-	-	-	0 - 5
		CEM II A-W	80 - 94	-	-	-	-	-	6 - 20	-	-	-	-	0 - 5
		CEM II B-W	65 - 79	-	-	-	-	-	21 - 35	-	-	-	-	0 - 5
	Portland-burnt shale cement	CEM II A-T	80 - 94	-	-	-	-	-	-	6 - 20	-	-	-	0 - 5
		CEM II B-T	65 - 79	-	-	-	-	-	-	21 - 35	-	-	-	0 - 5
Portland-limestone cement	CEM II A-L	80 - 94	-	-	-	-	-	-	-	6 - 20	-	-	0 - 5	
	CEM II B-L	65 - 79	-	-	-	-	-	-	-	21 - 35	-	-	0 - 5	
	CEM II A-LL	80 - 94	-	-	-	-	-	-	-	-	6 - 20	-	0 - 5	
	CEM II B-LL	65 - 79	-	-	-	-	-	-	-	-	21 - 35	-	0 - 5	
Portland-composite cement(c)	CEM II A-M	80 - 94	6 - 20	6 - 20	6 - 20	6 - 20	6 - 20	6 - 20	6 - 20	6 - 20	6 - 20	6 - 20	0 - 5	
	CEM II B-M	65 - 79	21 - 35	21 - 35	21 - 35	21 - 35	21 - 35	21 - 35	21 - 35	21 - 35	21 - 35	21 - 35	0 - 5	
CEM III	Blastfurnace cement	CEM III A	35 - 64	36 - 65	-	-	-	-	-	-	-	-	0 - 5	
		CEM III B	20 - 34	66 - 80	-	-	-	-	-	-	-	-	0 - 5	
		CEM III C	5 - 19	81 - 95	-	-	-	-	-	-	-	-	0 - 5	
CEM IV	Pozzolanic cement(c)	CEM IV A	65 - 89	-	11 - 35	11 - 35	11 - 35	11 - 35	11 - 35	-	-	-	0 - 5	
		CEM IV B	45 - 64	-	36 - 55	36 - 55	36 - 55	36 - 55	36 - 55	-	-	-	0 - 5	
CEM V	Composite cement(c)	CEM V A	40 - 64	18 - 30	-	18 - 30	18 - 30	18 - 30	18 - 30	-	-	-	0 - 5	
		CEM V B	20 - 39	31 - 50	-	31 - 50	31 - 50	31 - 50	31 - 50	-	-	-	0 - 5	

Notes:

(a) The values in the table refer to the sum of the main and minor additional constituents.

(b) The proportion of silica fume is limited to 10%.

(c) In portland-composite cements CEM II A-M and CEM II B-M, in pozzolanic cements CEM IV A and CEM IV B, and in composite cements CEM V A and CEM V B, the main constituents other than clinker shall be declared by designation of the cement.

Source: Cement & Concrete Institute of South Africa

### 8.3.3 STONE AGGREGATE

Stone aggregate is the coarse aggregate which normally consists of crushed stone, crushed or uncrushed gravel which consists of materials which are mainly retained on a 5mm sieve. Characteristics of concrete are directly related to those of the aggregates. Aggregates should therefore be durable and chemically inert under conditions to which they will be exposed. Nominal maximum sizes of coarse aggregates are usually 50mm, 40mm, 20mm, 13mm and 10mm depending on the intended use of the concrete. As a guide the maximum size of the aggregate should not exceed 25% of the minimum member thickness and should not exceed the design cover to the reinforcement.

Stone aggregates used in concrete work must be clean and free from clay, loam, vegetable and other organic matter. Stockpiling of aggregates should ensure that segregation is avoided. All washed aggregates should be stacked and allowed to drain for at least twelve hours.





### 8.3.4 SAND

Sand is fine aggregate most of which passes a 5mm sieve. It is used as an ingredient in concrete that fills the voids in coarse aggregates to produce a dense concrete and reduce the quantity of cement used.

Sand used in concrete work should be clean and free from impurities such as clay, silts, salts, mica and organic matter. Coal particles in sand are particularly undesirable as they corrode reinforcement. Sea sand is generally too fine and its salts tend also to attack the reinforcement. Sands with salts in high concentration also tend to retard setting and hardening of cement in the concrete also causing efflorescence though this will not adversely affect the ultimate strength.

The following simple field tests are used for determining the extent of contamination of the sand used in concrete:

- **Test for silt or clay:** An approximate test may be carried out by rubbing a sample of sand between damp hands and noting the palm discolouration. Clean sand will leave the palms slightly stained whilst silty or clayey sands will leave them dirty.
- **Decantation test:** This is a more precise test. Half fill a constant diameter glass with sand and then fill it up to three quarters with clean potable water. Mix the contents thoroughly by shaking the glass and then allow it to settle for an hour. Clean sand will settle immediately and the presence of clay will leave the water at the top muddy. Clay/silt will slowly settle as a layer on top of the sand. If the thickness of the clayey layer is more than 6% (one seventeenth) of sand layer then the sand needs washing.
- **Test for organic Impurities:** Place a sample of sand in a glass bottle with an equal volume of a 3% solution of caustic soda (i.e. 25 grams in 1 litre of water) and then allowing the mixture to stand for 24 hours. The water mixture above the sand should normally be pale yellow if the sand is clean. If the water mixture is markedly yellow or brown this indicates the presence of excessive amount of organic material.

## 8.4 MIXING OF CONCRETE

As stated above there are many types of concrete manufactured by varying the proportions of the main concrete ingredients.

### 8.4.1 TYPE OF MIXES

A mix design is influenced by the type of structure being constructed, environmental considerations, properties of the materials and workmanship amongst other. Concrete mixes are usually specified arbitrarily in the ratio of 1 bag of cement to sand and stone aggregate for example 1:2:4. Normally when volume batching, a 50kg bag of cement is taken to have a volume of 35 litres. Different manufacturers of cement specify that a bag of cement volume to range from 33 to 36 litres. *Assuming a bag to be equivalent to 35 litres, this means that a 1:2:4 mix will be one 50kg cement bag with 70 litres (2 x 35 litres) of sand and 140 litres (4 x 35 litres) of stone.* This fundamental concept of concrete mixing is very important for concrete professionals, designers and end users.

The following gives a guide of concrete mixes for different uses.

**Table 8-3: Concrete Mix Guide for Different Applications**

Concrete Mix Guide	Suitable Types of Construction
1 : 1 : 2	Heavily loaded reinforced columns; long span arches
1 : 1.5 : 2	Reinforced Concrete reservoirs and water retaining structures; concrete roads; concrete piles; fence posts; precast Reinforced concrete members; other works where dense concrete for impermeability or high strength.
1 : 2 : 4	Normal Reinforced Concrete works in beams, columns, walls, arches, road slabs.
1 : 2.5 : 5 1 : 3 : 6	Mass concrete in superstructures; massive Reinforced concrete members; bases to machinery; walls below ground, house foundation footings, foundation footings for single storey light structures; cement concrete blocks
1 : 4 : 8 1 : 5 : 10 1 : 6 : 12	Mass concrete foundations; Lean mixes to replace incompetent foundation soils.

Source: Indian Civil Engineer Practical Handbook

The concrete mix design is always subject to approval by the Engineer.

### 8.4.2 PROPERTIES OF CONCRETE

Strength and durability are generally considered the most important qualities of concrete. Other important properties of concrete that are not discussed in this document include creep, shrinkage, elastic modulus, fire resistance, abrasion resistance and thermal conductivity.

#### Strength

Compressive strength is the most common measure of assessing concrete quality. The characteristic strength of concrete is its compressive strength based on a 28-day cube strength. The 150mm cubes are compressed to failure after 28 days of mixing and the crushing strength is noted and recorded giving the sample's characteristic strength. Testing is usually done using a suitable compression testing machine.

#### Durability

Durability of concrete is concerned with its ability to withstand environmental conditions. Durability is directly related to concrete's permeability. In concrete design and construction the main requirements for durability are intrinsically governed by the following:

- Setting an upper limit to the water cement ratio
- Setting a lower limit for the cement content
- Setting a lower limit to concrete cover to reinforcement
- Ensuring good compaction
- Ensuring adequate curing

Conforming to the above ensures durability of the concrete.

### 8.4.3 WATER-CEMENT RATIO

The strength of concrete depends to a great extent on the amount of suitable water used in mixing. The amount used should be the minimum necessary to give sufficient workability for efficient consolidation of the concrete. Using too much water will compromise ultimate strength of the concrete whilst using less water will reduce workability and also compromise quality. The amount of water is specified by weight and stated as a fraction of the cement used alternatively weight of water divided by weight of cement:

$$\text{Water Cement Ratio} = \frac{\text{Weight of Water}}{\text{Weight of Cement}}$$

If the sand is damp (moisture can amount up to 25% of the weight) then the added water quantity has to be reduced. A simple hand test helps to determine whether the mix has the right consistency and water content:

- Pick a handful of mixed concrete and form a ball in your hand. If this is not possible, then the mix is too wet.
- Drop this ball onto a hard surface and observe whether the ball retains its general shape. If the ball totally collapses, then the mix is too wet.

### 8.4.4 BATCHING FOR CONCRETE MIXING

Batching (measuring material proportions) can be done in two ways, namely by volume or by weight. Concrete on site is usually mixed by hand for minor concrete works and/or small volumes of concrete, or with a concrete mixer for major works and/or large volume of concrete. It is recommended that hand mixing is used for minor works involving low grade concrete (say 25MPa or less) such as culverts and manhole bases, most housing projects, in order to maximize employment creation. In urban areas Pre-mix concrete suppliers are readily available. When volume batching, in order to achieve the required mix proportions gauge boxes are used to batch the dry aggregates. The

<sup>15</sup> Reinforced and Prestressed Concrete, FK Kong et al, 3rd Edition ELBS 1989



gauge box, made out of wood or steel, has the same volume as a 50kg bag of cement (35 litres) when filled level with the top. The box has handles for ease of lifting and unloading within mixing areas or at concrete mixers. See Figure 8-1 below.

For water retaining structures weigh batching is strongly recommended because of the quality requirements.

Figure 8-1: Concrete Gauge Box

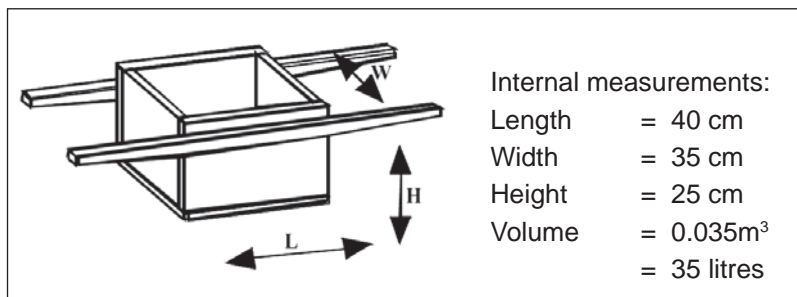

The Table below gives prescribed mixes for ordinary Portland cement using volume batching. Table 8-4 assumes mechanical vibration of the concrete.

Table 8-4: Concrete Mix Guide for Different Grades of Concrete

Grade	Mix Ratio	Water Cement Ratio	Nominal Stone Size
10 MPa	1 : 4 : 8	0.85	50 mm
15 MPa	1 : 3 : 6	0.70	19 mm
20 MPa	1 : 2.5 : 5	0.60	19 mm
25 MPa	1 : 2 : 4	0.56	19 mm
30 MPa	1 : 1.5 : 3	0.52	19 mm
40 MPa	1 : 1 : 2	0.50	19 mm

Source: DPW Specification 377

### 8.4.5 HAND MIXING

Hand mixing involves the use of labour and simple hand tools such as shovels, spades, and watering cans to appropriately mix concrete on prepared platforms. Hand-mixed batches should not exceed 0.5m<sup>3</sup>. The mixing should never be done on the bare ground, as this will result in contamination of the mix. A platform of about 4m by 4m has to be built with timber boards, metal sheets or lean concrete. The following are typical steps for hand mixing:

- Measure the amount of sand and stones with the gauge box according to the specified ratio and place them in alternating layers on the platform.
- Spread the required quantity of cement over the top.
- The dry materials should be mixed at least three times. Two persons, one on each side of the heap, shovel the heap to a convenient spot, turning the material in the process. This operation is repeated, the heap being thrown back to its original position and then back again until the colour of the dry mix is uniform.
- Water is then added by a third person while turning the mix the fourth time using a watering can or a bucket (use your hand to sprinkle from the bucket) so that the water is spread evenly while the material is mixed again. Only the correct amount of water should be added. The mixing must be continued (to be turned at least three times) until the concrete is uniformly wet and has reached the required consistency (See figure below).
- Another, often applied method is to spread the dry mix, make a hollow in the middle and then add the water into this hollow. Afterwards the mixing is done very carefully to avoid any of the water from the middle getting lost.

Figure 8-2: Hand mixing of Concrete

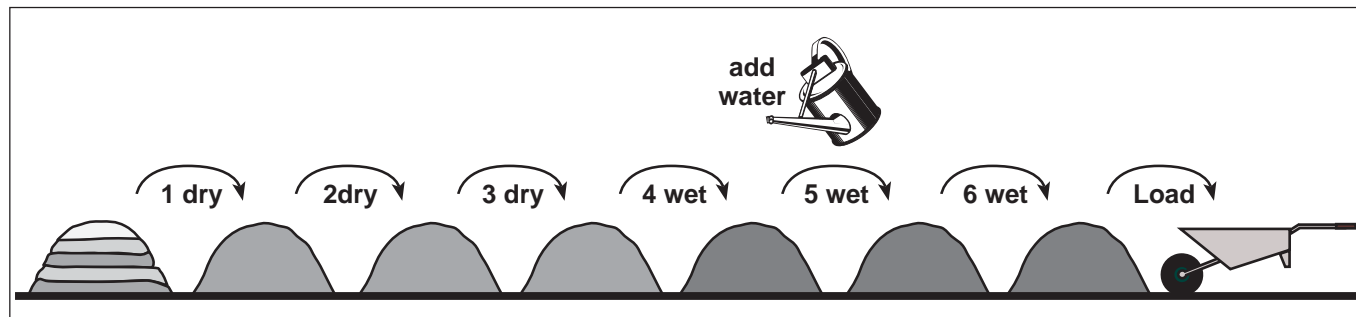

### 8.4.6 MACHINE MIXING

Machine mixing is the process of using mechanical equipment to manufacture concrete. This section focuses on the use of mobile concrete mixers. These are normally used on site in combination with labour and hand tools. Batch Concrete Mixers are available in tilting and non-tilting types. Tilting Mixers tilt to discharge their contents whilst non-tilting ones empty their contents by means of chutes. Concrete mixers sizes are designated by two numbers say 142/100; 199/142 in the metric system (*alternatively in imperial units is stated as 5/3.5; 7/5*). The first figure indicates the drum capacity in litres (*alternatively in imperial units in cubic feet*) and this is the capacity of the mixer for dry materials. The second indicates the approximate volume of concrete produced in litres (*alternatively in cubic feet*). *A 142/100 mixer produces 100litres of concrete from 142 litres of dry materials (alternatively a 5/3.5 mixer produces 3.5 cubic feet concrete from 5 cubic feet of dry materials).*

The following are typical steps for concrete mixing using field mechanical mixers:

- Step 1: Transport batched materials close to the mixer.
- Step 2: Stone aggregate is placed first in mixer hopper followed by sand and then cement.
- Step 3: A small quantity of water is then added into the revolving drum to lubricate it followed by the dry mixture to achieve uniformity.
- Step 4: Add the remaining quantity of water gradually whilst mixing. The concrete should be mixed for at least two minutes until the concrete is uniform in colour and consistency.
- Step 5: After each batch is discharged the drum should be washed clean before placing the next batch.

The Table below gives an estimate of suggested concrete output rates for selected concrete mixers.

Table 8-5: Concrete Mixer recommended Minimum Daily Outputs

Mixer Size Type	Output per eight hour Shift in m <sup>3</sup> /shift (6 hours operations plus 2 hours rest and clean-up)	
	With a Hopper	Without a Hopper
142/100 (5/3.5)	11.0	7.3
199/142 (7/5)	14.0	9.3
284/199 (10/7)	17.5	11.7



## 8.4.7 STANDARD FIELD TESTS

### Slump Test

The following is a typical slump test procedure:

The apparatus and the method of determination of the slump of freshly mixed concrete shall comply with SABS STM 862.

**(a) Apparatus:**

(i) A mould in the form of a frustum of a cone and having the following nominal internal dimensions:

Bottom diameter: 200mm      Top diameter: 100mm      Height: 300mm

The mould shall be of a metal (other than brass or aluminium) of side thickness at least 1.6mm and shall have a smooth internal surface.

The mould shall have suitable base plate and handles to facilitate lifting it from the test specimen in a vertical direction.

(ii) The tamping bar shall have a nominal diameter of 16mm, a length of 600mm and with sharp corner rounded off at one end.

**(b) Procedure:**

The test shall be carried out in an area that is free from vibration and shocks.

Ensure that the internal surfaces of the mould are free from set concrete and are clean and dry.

Place the mould with the bottom on a smooth, horizontal, rigid, non-absorbent surface and hold the mould firmly in place while it is being filled as follows:

(i) Fill the mould in four layers, each thickness approximately one-quarter of the height of the mould. Tamp each layer with 25 strokes uniformly spaced over the cross-section of the mould. Tamp the bottom layer throughout its depth and ensure that when tamping the second and subsequent layers the strokes penetrate into the underlying layer.

(ii) After the top layer has been tamped, strike off the concrete level so that the mould is exactly filled. Clean off any concrete that may have leaked out between the mould and the supporting base plate surface. Remove the mould from the concrete immediately by slowly and carefully raising it in a vertical direction. This will allow the concrete to subside.

Immediately measure the slump, to the nearest 5mm, by determining the difference between the height of the mould and the height of the specimen.

If the specimen slumps more than 75mm, collapses or shears off laterally regard the test as invalid, discard the result and repeat the test.

Source: NDPW Specification 371

### Sampling of Concrete Cubes

The following is a procedure for sampling of 150mm concrete cubes:

The apparatus for making and testing of concrete cubes shall comply with SABS STM 863.

(a) **Apparatus:** Cubic metal moulds of steel shall be machined and adequately strengthened to resist distortion. The internal distance between faces of a mould shall be 150mm.

The mould shall be constructed so as to facilitate the easy removal without damage of the moulded specimen.

Each mould shall have a metal base plate which shall be attached to the mould by springs or screws.

When assembling the mould for use, the joints between the sections of the mould, the contact surfaces

between the bottom of the mould and the base plate, and the internal faces of the assembled mould shall be thinly coated with a grease or oil that will prevent leakage of water through the joints and adhesion of the concrete to the mould.

The tamper must be a steel bar of length 400mm and mass 1.8kg, and having a 25mm square ramming face.

(b) **Sampling and making cubes:** Sampling shall comply with SABS STM 861.

One set of three cubes shall be required for every 40 cubic metres, or part thereof, of concrete cast.

The sample taken from a batch of concrete and sufficient to make three cubes shall be placed in a tray or on a platform and mixed thoroughly.

The moulds shall each be filled in three layers approximately 50mm thick. Each layer shall be compacted with the tamping rod as previously specified, with at least 35 blows to give full compaction of the concrete.

After the top layer has been compacted, strike off the surface of the concrete with a trowel, level with the top of the mould.

Any small hollows shall be filled in with additional concrete. Cement/sand slurry shall not be worked into the surface.

At this stage, the identity of each sample shall be placed on the moulded cube, by means of a label of absorbent material and not by scouring of the surface of the concrete.

(c) **Curing cubes on site:** Cover the test cubes in their moulds with an impervious sheet or wet sacking and store indoors in a place that is free from vibration, excessive draughts, cold and direct sunlight.

After 24 hours the cubes shall be de-moulded, remarked with a waterproof crayon or marker and placed in a curing tank for seven days before being transported to the laboratory.

The Contractor shall supply the curing tank which shall incorporate a thermostat to control the water temperature at 22°C to 25°C and shall be kept within a building.

Source: NDPW Specification 371

## 8.5 TRANSPORTATION OF CONCRETE

Concrete should be mixed as near as possible to the site of placement to avoid segregation during transport and to shorten the time between mixing and placing. On site, concrete is usually transported in wheelbarrows or buckets.

## 8.6 PLACING AND COMPACTION OF CONCRETE

Concrete should be placed in position as soon as possible and before setting has begun. Concrete should be placed within one hour of discharge of concrete mixer. If hand mixed concrete should be placed within fifteen minutes of mixing.

The formwork, or shuttering, must be clean, secure from movement or leakage and should be wetted before the concrete is filled in. Steel and wooden formwork should be oiled (used engine oil mixed with diesel is acceptable for this purpose) to allow it to be removed easily later on.

Compaction of concrete may be undertaken in two ways, namely manually by hand ramming or by mechanized vibrator (poker vibrator). For concrete layers of thickness not exceeding 30cm hand vibration may be considered. This may be increased to 50cm when a vibrator is used. Each layer must be rammed or vibrated before the next layer is spread. As a rule of thumb, sufficient compaction is achieved when water appears on the surface and/or drips through the joints of the formwork, provided the water/cement ratio is correct and the formwork has been constructed with tight joints. Care must be taken not to over-vibrate the layers as this leads segregation and compromise on ultimate strength.

Manual vibration should be carried out using a round steel reinforcement bar, a rammer is not acceptable. Poke the bar in small distances deep into the concrete layer, twist the bar and move it up and down at the same time. Repeat this procedure at every 10cm to 15cm in all directions on the layer.



It should be ensured that before concrete placing, reinforcement should be free from loose scales, loose and/or scaly rust, oil and grease. A thin coat of light rust which firmly adheres to the steel bars is not considered harmful. When steel rods are to be stored for long periods they may be given a cement wash to mitigate against rusting and placed off the ground with covering against the rain. Loose rust can be removed by using wire brushes. Oil, grease and paint may be removed by mild heat from say a blow torch. Overheating of steel rods should be avoided at all costs.

### 8.7 CURING CONCRETE

Curing of concrete is the process of the provision of moisture and favourable temperature to enable cement to continue to hydrate thereby increasing the strength of concrete<sup>16</sup>.

When water is added to cement chemical reactions, commonly known as hydration of cement, take place which result in the setting and hardening of cement<sup>17</sup>. The concrete should be maintained at a temperature of between 5°C and 20°C in the first half day after casting as higher temperatures may retard future development in strength whilst lower temperatures may reduce significantly the ultimate strength of the concrete. It is generally accepted that concrete continues to harden for at least one year after casting. Table 8-6 below shows the relationship of strength and concrete age over a period of one year.

Table 8-6: Comparative Strength of OPC Concrete

Age	Strength as a Percentage of Specified Criteria
3 days	40%
7 days	65%
28 days	100%
3 months	115%
6 months	120%
12 months	130%

Source: Indian Civil Engineer's Practical Handbook

It takes at least 28 days for concrete to gain full strength. This time span is called the curing period, and special care must be provided during this time.

Concrete slabs must be kept constantly wet. This can be achieved by any or combination of the following:

- Covering the slab with damp sand (needs to be watered from time to time);
- Covering the slab with wet canvas (needs to be kept wet);
- Covering the slab with polyethylene sheets (additional water must be added from time to time);
- Continuously watering the slab.

Concrete walls should also be protected from direct sunshine and the crown should be covered with wet canvas, polyethylene sheet or leaves. Water should be added to the crown at least during the first 7 days.

Formwork shall not be removed before the stipulated time in the specification. Table 8-7 below gives a guideline for formwork striking off (removal) times.

<sup>16</sup> Reinforced and Prestressed Concrete, FK Kong et al, 3rd Edition ELBS 1989

<sup>17</sup> Indian Practical Civil Engineers' Handbook, 13th Edition, PN Khanna, Engineers' Publishers, 1991

**Table 8-7: Formwork Striking off Times**

DESCRIPTION	Minimum period for removal of formwork in days for			
	Normal Cement		Rapid Hardening Cement	
Weather:	Normal	Cold	Normal	Cold
Beam sides, walls, unloaded columns	2	4	1	2
Slabs with props left under	4	7	2	4
Beam soffits with props left under including ribbed slabs	7	12	3	5
Removal of slab props	10	17	5	9
Removal of beam props	14	28	7	12

Source: NDPW Specification 371

## 8.8 CONCRETE REINFORCEMENT

Generally concrete is weak in tension and strong in compression. Different types of reinforcements are usually employed to improve its tensile strength. These include steel reinforcing bars, steel plates, welded steel fabric reinforcement, glass fibre and plastic fibre. Steel Bars and welded steel fabric are the most commonly used due to the abundance of steel in Africa.

### 8.8.1 STEEL REINFORCEMENT

Mild Steel, High tensile steel bars and welded steel fabric reinforcements (mesh)<sup>18</sup> are normally used as reinforcement. Typically mild steel has yield strength of 250 and 300 N/mm<sup>2</sup>, for high tensile steel yield strengths of 410, 450 and 460 N/mm<sup>2</sup> are common. Bars are normally supplied in lengths of 6 to 18 metres in increments of 1 metre as ordered for sizes 6, 8, 10, 12, 16, 20, 25, 32 and 40 mm diameters.

## 8.9 HAZARDS IN HANDLING CONCRETE

Cement is essentially a chemical and like many other chemicals exposure to it may have adverse health effects. Care therefore has to be taken in concrete manufacture, transportation and placing in order to mitigate potential hazards. Table 8-8 below outlines common hazards and suggested mitigations in the handling of cement and concrete.

**Table 8-8: Common Hazards of Handling Concrete**

SOURCE	HAZARDS	MITIGATIONS
Cement Dust	Exposure to cement dust can irritate eyes, nose, throat and the upper respiratory system. Skin contact may result in moderate irritation to thickening/cracking of skin to severe skin damage from chemical burns. Silica exposure can lead to lung injuries including silicosis and lung cancer.	<ul style="list-style-type: none"> <li>Rinse eyes with water if they come into contact with cement dust and seek medical attention.</li> <li>Use soap and water to wash off dust to avoid skin damage.</li> <li>Wear a P, N or R-95 respirator to minimize inhalation of cement dust.</li> <li>Eat and drink only in dust-free areas to avoid ingesting cement dust.</li> </ul>
Wet Concrete	Exposure to wet concrete can result in skin irritation or even first, second or third-degree chemical burns.	<ul style="list-style-type: none"> <li>Wear alkali-resistant gloves, overalls or work suits with long sleeves and full-length trousers, waterproof boots and eye protection.</li> <li>Wash contaminated skin areas with cold, running water as soon as possible.</li> <li>Rinse eyes splashed with wet concrete with water for at least 15 minutes and then go to a health facility for further treatment.</li> </ul>

<sup>18</sup> In South Africa Reinforcement bars have to comply to SANS 920 and Fabric reinforcement to SANS 1024.





Source	Hazards	Mitigations
<b>Machine Guarding</b>	Unguarded machinery used in the manufacturing process can lead to worker injuries.	<ul style="list-style-type: none"> <li>• Maintain moving parts to avoid jamming and use care in clearing jams.</li> <li>• Ensure that guards are in place to protect workers using mixers, block makers and metalworking machinery such as rebar benders, cutters and cage rollers.</li> <li>• Establish and follow effective laid down procedures when servicing equipment.</li> <li>• Be sure appropriate guards are in place on power tools before using them.</li> </ul>
<b>Falling Objects</b>	Workers may be hit by falling objects.	<ul style="list-style-type: none"> <li>• Avoid working beneath areas with risk of falling objects.</li> <li>• Stack and store materials properly to limit the risk of falling objects.</li> <li>• Wear eye protection when chipping and cleaning forms, products or mixers.</li> <li>• Wear hard hats at all times.</li> </ul>
<b>Poor Workplace and Equipment Practices</b>	Improper lifting, awkward postures and repetitive motions can lead to sprains, strains and other musculoskeletal disorders.	<ul style="list-style-type: none"> <li>• Use hand carts or forklifts for loads greater than 50kg for male workers and 32kg for female workers.</li> <li>• Lift loads properly.</li> <li>• Avoid twisting while carrying a load. Shift your feet and take small steps in the direction you want to turn.</li> <li>• Keep floors clear to avoid slipping and tripping hazards.</li> <li>• Avoid working in awkward postures.</li> </ul>
<b>Confined Spaces</b>	Generally working in confined spaces poses safety risks. Also mixers and ready-mix trucks have confined spaces that pose safety risks for workers.	<ul style="list-style-type: none"> <li>• Follow established procedures for confined space entry and work to assure safety.</li> <li>• Guard against heat stress when cleaning truck mixer drums.</li> <li>• Wear appropriate protective equipment to avoid silica exposure when removing concrete residues from inside truck mixer drums.</li> <li>• Wear necessary protective equipment such as hard hats, safety harnesses, respirators when working in a confined space.</li> </ul>
<b>Vehicles</b>	Poorly maintained or improperly handled vehicles can lead to crushing injuries at the plant site or other injuries for truck drivers.	<ul style="list-style-type: none"> <li>• Make sure reversing alarms on all vehicles are functioning.</li> <li>• Avoid overloading cranes and hoists.</li> <li>• Exercise care with the load out chute on concrete mixers to avoid injuries to hands and fingers.</li> <li>• Beware of hot surfaces on equipment and truck components.</li> <li>• Guard eyes against splashes of aggregate materials during loading and unloading.</li> <li>• Use hearing protection if needed to guard against excessive noise exposure during cement loading/unloading and while using pneumatic equipment inside truck mixer drums.</li> </ul>

Source: Occupational Health and Safety Administration

## 9. MASONRY WORKS

Masonry is the building of structures and civil works from individual relatively small units laid in and bound together by mortar usually being cement mortar. The term “masonry” can also refer to the units themselves. The most common materials of masonry construction are brick, natural stone such as marble, granite, travertine, limestone; concrete brick and block; glass block, and tile. Masonry is generally a highly durable form of construction. However, the quality of materials used, the quality of the mortar and workmanship, and the pattern in which the units are assembled in can strongly affect the durability of the overall masonry construction<sup>19</sup>.

Masonry work is employed for the construction of many capital assets such as houses, buildings (institutional, industrial and commercial); aspects of civil works including, drains, sanitation systems, retaining walls of all kinds, reservoirs, water collection points and so on.

The choice materials used depends on: a) the purpose of the asset; b) the availability of the materials; and c) cost. Masonry structures may be load bearing (structural) or aesthetic (decorative).

All the above-mentioned types of masonry including their production processes are predominantly employment intensive. Hence, it is strongly recommended that designers and builders make use of these materials where they are locally available in order to increase labour intensity in projects and stimulate local economies.

It is important to know the principle uses and the limitations of various types of masonry. This chapter provides simple guidelines for minor works in water, sanitation and building works.

It is also important to note that infrastructure assets are usually exposed to water and other elements, and therefore only cement bound masonry are recommended. Lime or lime-cement mortar can only be used for objects which are not exposed to water, like building walls and plaster above the ground level.

Dry stone masonry may be used for retaining walls, culvert head walls and wing walls, and other minor masonry work where the structure does not need to be watertight. Dry stone masonry is also used to fill gabion boxes and mattresses.

### 9.1 MATERIALS FOR CEMENT BOUND MASONRY

#### 9.1.1 SAND

Clean building sand, with the same requirements as for concrete manufacture.

#### 9.1.2 CEMENT

With the same requirements as for concrete manufacture.

#### 9.1.3 WATER

With the same requirements as for concrete manufacture.

#### 9.1.4 MASONRY STONE

It is important to choose only good sound stones to build foundations, walls and for linings. The following cannot be used for load bearing masonry structures:

- weathered stones;
- cracked stones;
- small stones (minimum length of sides = 20cm);
- coral.

<sup>19</sup> Source: <http://en.wikipedia.org/wiki/Masonry>



### 9.1.5 BRICKS

The term brick refers to a masonry unit which has a specified length, width, height and strength. Bricks can be made from clay; sand and cement mixture; sand and lime; or crushed aggregate and cement mixture. The majority of bricks are made from different types of clays. Since clays differ in their mineral content, therefore clay bricks differ in their physical properties depending on the constituents of clay used in their manufacture. Differences in colour and texture are obvious, but strength, density and durability also differ.

Figure 9-1: Brick work in a construction site



The most common brick clay size in South Africa is 222mm long x 106mm wide x 73mm high. Clay Brick sizes vary depending on the manufacturer. Table 9-1 below shows other sizes of clay bricks available in South Africa.

Table 9-1: Available Common Brick Sizes

Description	Dimension in mm			
	Length	222	220	190
Width	106	110	106	140
Height	73	73	90	114

Source: Clay Bricks: Technical Guide

### 9.1.6 BLOCKS

The term blocks refer to masonry units which are generally larger than brick. They are normally made of sand and cement mixture; industrial wastes and cement mixture; clay or stone.

Table 9-2 below gives details of different types of cement based and clay blocks:

The blocks are normally classified as dense aggregate, lightweight aggregate (load bearing) and lightweight aggregate (non-load bearing) blocks. Dense aggregate blocks are suitable for general use in load bearing external walls both above and below the damp proof course. Lightweight aggregate (load bearing) are used for load bearing internal walls both above and below the damp proof course. Lightweight aggregate (non-load bearing) blocks are used for non-load bearing internal walls above the damp proof course. The sizes of commonly used blocks are given in Table 9-3 below.

For infrastructure assets only cement bound blocks should be used. They should be of high strength as specified and equal size (tolerance plus/minus 2mm per block). Cement or concrete bricks shall not be wetted before use.

Table 9-2: Types and Characteristics of Blocks

Type of Block	Materials Used	Surface Texture and/or Features
<b>Cement Block</b>	Coarse natural sand or crushed rock dust mixed with cement and water and pressed into shape	Rough porous surface. Cement grey colour.
<b>Clinker</b>	By products of high-temperature coal boiler furnaces.	Angular in shape. Dark in colour.
<b>Foamed Slag</b>	By-products from iron manufacture. Blast furnace slag is chilled and expanded then crushed and screened.	Angular and porous.
<b>Sintered Fly Ash</b>	By-product from power stations using pulverized coal fuel.	Porous nodules and pellets both fine and coarse graded.

Type of Block	Materials Used	Surface Texture and/or Features
<b>Wood Sawdust</b>	By-product of woodwork shops. Mixed with sand and cement and pressed into blocks.	Porous. Wood shavings seen on surface.
<b>Expanded Clay</b>	Clay expanded with sulphite ley and burnt	Angular or rounded depending on method of manufacture.
<b>Aerated Concrete</b>	Siliceous material with addition of aluminium powder.	Porous.

Source: M.O. Obande

**Table 9-3: Sizes of Commonly used Blocks**

Type of Blocks	Actual Size	Norminal Size
	Length x Height x Width (mm)	
<b>Dense Aggregate</b>	440 x 140 x 90	450 x 150 x 100
	440 x 215 x 215	450 x 225 x 225
	440 x 215 x 140	450 x 225 x 150
<b>Lightweight Aggregate (Load Bearing)</b>	440 x 140 x 90	450 x 150 x 100
	440 x 215 x 140	450 x 225 x 150
	140 x 150 x 215	150 x 150 x 225
	440 x 140 x 65	450 x 150 x 75
<b>Lightweight Aggregate (Non-Load Bearing)</b>	450 x 215 x 40	440 x 215 x 65
	450 x 225 x 50	450 x 225 x 75

Source: M.O. Obande

## 9.2 CEMENT MORTAR

Mortar is a mixture of cement, sand and water in specified proportions. The mortar binds the stones, bricks or blocks together. The strength of the bond depends on factors such as:

- the type and amount of cement used;
- the amount of water used;
- the type and quality of sand;
- the quality of workmanship;
- the curing of the mortar.

The mortar should be made in accordance to specification or to Supervisor/Engineer’s instruction. Table 9-4 below gives recommendations for different types of masonry based on loading conditions.

**Table 9-4: Mortar Mixes for Different Uses**

Construction Type	Mixture (cement : sand)
Non-bearing walls:stone lining, minor walls	1 : 7
Small retaining walls:head- and wing walls, retaining walls up to 1 metre height General masonry to buildings:	1 : 6
Load Bearing walls:walls for structures, retaining walls higher than 1 metre, foundations	1 : 4



Box 9-1 below gives recommendations of the Cement and Concrete institute of South Africa.

### Box 9-1: Mortar Mixes for Masonry

Mortar binds bricks and blocks together to give strength and stability to a wall. Freshly mixed mortar must be soft and plastic so that it spreads easily and makes good contact without becoming too strong. Too strong a mortar may crack and is wasteful as it is more expensive.

#### 1. Materials

##### 1.1 Cement

Preferred cement types are:

- Common cement complying with SANS 50197-1
- Masonry cement complying with SANS 50413-1; strength class 22,5X.

Cement is sold in 50kg bags and in bulk.

Cement must be kept in dry storage. If there are hard lumps in the cement that cannot be crumbled by hand, it is not fresh and should not be used. The performance of products claiming conformance with SANS 50413 strength class 12,5X is not supported by independently published data.

##### 1.2 Lime

Use only building lime complying with SANS 523: 2002. Do not use quick-lime or agricultural lime. Lime is sold in 40kg bags. Lime should be used if the sand lacks fine material or is single sized, as such sands tend to produce mortar with poor workability unless lime is included in the mix. Lime also helps the fresh mortar to retain water when it is placed against dry cement bricks or blocks and helps to prevent cracking of the hardened mortar. A maximum of 40 litre of lime is permitted per 50kg of cement. Do not use lime with masonry cement.

##### 1.3 Sand

The sand should be clean (grass, leaves, roots, etc. are harmful) and it should not contain too much clay. It should consist of hard particles which range in size from dust up to about 2mm. Pit sands generally have these characteristics. River, dune and beach sands are often too uniform in size (single sized) to give good results.

#### 2. Mix proportions

The proportion of each material in the mix should suit the type of work being done. Strength requirements and mix proportions, recommended by C&CI, are given in Table 1. In general terms the classes of mortar may be used as follows:

##### Class I

Highly stressed masonry incorporating high-strength structural units such as might be used in multi-storey load bearing buildings; reinforced masonry.

##### Class II

Normal load bearing applications, as well as parapets, balustrades, retaining structures, and freestanding and garden walls, and other walls exposed to possible severe dampness.

In practice, Class II mortars are used for most applications. Although SANS 10249: refers to a Class III mortar, it is so seldom used that it has been omitted from Table 1. Other proportions may be used if these can be shown by test to be satisfactory.

Mortar must not be used after it has started to set, which usually occurs about two hours after it has been mixed. One man – particularly if he is a weekend builder – can probably lay a little more than 60 bricks an hour. If you are working on your own or with one assistant, it is better to mix a number of small batches as they are required than to mix a one-bag batch.

Do not use too thick a layer of mortar between bricks or blocks; this is wasteful and may lead to cracking.

### 3. Batching the materials

A builder's wheelbarrow is a convenient measure for large batches; the capacity is 65 litres. Steel drums of 20 litres or 25 litres capacity and buckets are useful for small batches. Check the capacity of drums and buckets when filled to the brim as this is often more than the nominal capacity. To batch, shovel material into the measure and then strike off level with the brim.

### 4. Mixing

Mixing should be done on a clean hard surface such as a smooth concrete floor or a steel sheet. Small batches may be mixed in a wheelbarrow provided that the volume of the batch is no more than half the capacity of the barrow. Sand and cement, and lime if used, should be mixed until the colour of the mix is uniform. Then add water in small quantities, mixing after each addition, until the mix is soft and plastic.

### 5. Handling

If mortar is left in the sun before being used, it should be covered with plastic sheeting or a wet sack. Discard mortar that has stiffened so much that it is impossible to restore workability without adding more water.

### 6. Quantities of materials

Quantities of cement and sand required per 50kg bag of cement or to produce 1m<sup>3</sup> of mortar are given in Table 1. Quantities required for block laying depend on block size and are outside the scope of this leaflet (See C&CI leaflet Quantities for ordering building materials.)

The addition of lime is optional. A maximum of 40 litres is permitted per 50kg bag of cement. Mix proportions do not need to be adjusted. Only yield will increase by 5 %.

Do not use lime with masonry cement.

Note that quantities in the table are approximate and do not allow for wastage, which could typically range from 10 - 20 %.

**Note:** Concrete bricks and blocks should not be wetted before being laid.

Burnt clay bricks should be wetted before being laid.

Mortar class	Minimum required compressive strength at 28 days, MPa		Quantity of sand <sup>1</sup> per 50 kg bag of cement, (litres)			Quantities of materials required per m <sup>3</sup> of mortar (not including wastage)		
	Preliminary laboratory test	Works tests	Common <sup>2</sup> cement 32,5, 42,5	Masonry <sup>3</sup> cement 22,5X	Common <sup>2</sup> cement 32,5, 42,5	Sand (m <sup>3</sup> )	Masonry <sup>3</sup> cement 22,5X	Sand (m <sup>3</sup> )
I	14.5	10	130	100	9	1.15	10.5	1.1
II	7	5	200	170	6.5	1.25	7.25	1.22

1. Sand is estimated at 5% moisture content.
2. Common cement complying with SANS 50197-1, strength class 32,5 or 42,5.
3. Masonry cement complying with SANS 50413-1, strength class 22,5X.

NOTE: For 90 - 110 mm thick single leaf walls, 1 m<sup>3</sup> of mortar will be sufficient to lay about 3700 bricks (190mm x 90mm x 90mm) without wastage. See note in section 6 above.

Source: Cement & Concrete Institute of South Africa



### 9.2.1 MORTAR MIXING



The mixing procedure for mortar is the same as for concrete. Rules of thumb for masonry mortar:

- the consistency should be such that it does not flow off the trowel;
- the mortar can be kneaded in the hand and retains its form (like dough);
- the quantity of mortar to be mixed should not be more than what a mason can use within one hour.

## 9.3 MATERIAL QUANTITIES

The Table below gives estimated for quantities.

**Table 9-5: Quantities for Different types of Masonry**

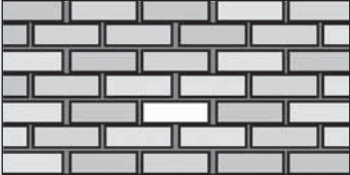
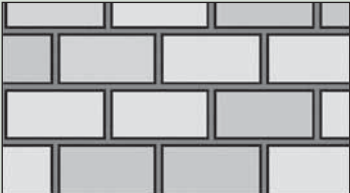
Type	Joint width	Quantities per m <sup>3</sup> of works
<p><b>Rubble stone masonry:</b> The stones are not specifically cut or shaped. To build a wall with proper bonding using rubble stones requires well developed skills from a mason.</p> 	1.0 cm to 4.0 cm	<p>Stones: approx. 1.3 to 1.5 m<sup>3</sup> (allowing for wastage)</p> <p>Mortar: 300 to 400 litres/m<sup>3</sup></p>
<p><b>Shaped stone masonry:</b> The stones are shaped to a rectangular prism. By using these stones it is easier to produce a wall with proper bonding and uniform surface.</p> 	1.0 cm to 2.5 cm	<p>Stones: approx. 1.2 m<sup>3</sup> (allowing for wastage)</p> <p>Mortar: 200 to 300 litres/m<sup>3</sup></p>
<p><b>Brick masonry:</b> Bricks can be of various sizes and can be laid in many different bonds.</p> 	1.2 cm to 1.5 cm	<p>Bricks: approx. 1.1 m<sup>3</sup> (allowing for wastage)</p> <p>Mortar: 250 to 270 litres/m<sup>3</sup></p>
<p><b>Block masonry:</b> Blocks can be of various sizes. Blocks may be of different material, e.g. burned clay, concrete, sand cement, etc.</p> 	1.2 cm to 2.0 cm	<p>Blocks: approx. 1.1 m<sup>3</sup> (allowing for wastage)</p> <p>Mortar: 200 to 250 litres/m<sup>3</sup> (depending on the size of the blocks)</p>

### 9.3.1 JOINTS AND BONDING

Masonry units are normally bound in cement mortar of varying thickness depending on the type of masonry unit used. These joints are of critical importance as they provide the friction induced bonding between masonry units. It also joins the bricks together to provide stability and solidity while at the same time holding them apart to spread loads evenly. It compensates for irregularity between units when straight, level and plumb walling is laid. It also seals any gaps to resist wind or rain penetration. As well as fulfilling its gap-filling adhesive function it is required to have durability and strength to suit the application. Due to the fact that the mortar in most cases is unreinforced its quality and thickness is critical to the strength of the resulting brick structure.

Bonding is a process whereby the unit blocks (stones, bricks or blocks) are arranged in pre-determined patterns to present a pleasant surface appearance and at the same time eliminate, as far as possible, straight joints.

### 9.3.2 COMMON TOOLS FOR MASONRY WORK

The following tools and protective clothing are usually employed in masonry works:

- Tape measure
- Square
- Plum bob with string
- Mason string or line
- Spirit level
- Line level and/or horse pipe (for transferring levels)
- Straight-edge
- Trowels, various shapes and sizes depending on the work
- Masonry hammer, various sizes and shapes depending on the work
- Chisels, various sizes and shapes, (e.g. flat and pointed)
- Wheelbarrow
- Mortar basin
- Floats, wooden and steel, various sizes depending on the work
- Protection goggles
- Helmet
- Protective gloves (mainly for stone masonry)
- Metal Sheets (for mortar mixing)

## 9.4 STONE MASONRY WORKS

### 9.4.1 FOUNDATIONS

Foundations for load bearing walls are usually made of reinforced concrete and need to be appropriately designed and specified in the contract specifications and drawings.

For minor walls up to 1.5m in height which do not support heavy loads, no special concrete foundation is required, instead different types of masonry foundations can be employed such as that shown in Figure 9-2 below.

However, some principle guidelines should be followed when building foundations such as:

- Foundation depth shall be a minimum 0.4m, on firm uniform ground;
- Use 100 mm lean concrete (1 : 4 : 8) as a base;
- The first course (footing course) should be laid with the largest and straightest stones since the stability of the wall depends largely on the bearing of the stones on the ground.

**Figure 9-2: Typical Stone Masonry Retaining Wall**

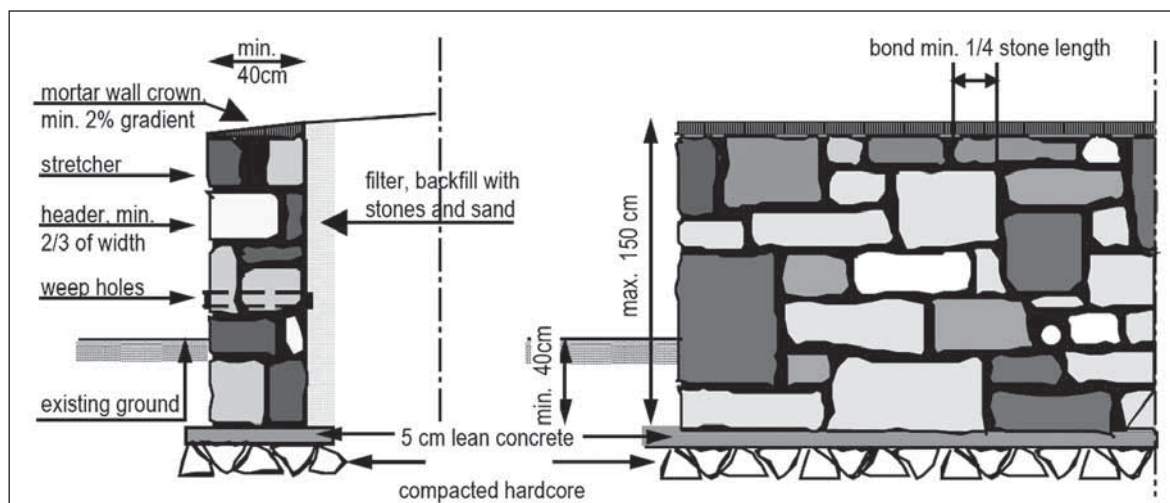





### 9.4.2 JOINTS

The spacing of joints must be provided depending on the type of joints. As an example the joint width are given below:

- for rubble stone masonry = 1cm to 4cm;
- for shaped stone masonry = 1cm to 2.5cm.

### 9.4.3 BOND

The bond should allow for a minimum overlap of 1/4 length of the smaller stone (see figure below). Most of the stones are laid as stretchers. Headers, or “through stones”, should be laid at regular intervals to bond the two faces of the wall together. These header stones should cover at least two-thirds of the wall’s thickness and their overlap should not be less than 10cm.

The ideal shape of stones for construction work is a rectangular prism. Stones which are too long, too flat, too round or irregular are difficult to use in construction, even in irregular laying. They may be used for lining drains where bonding is not an important criterion (no compression and tension as the slope of the drain is usually chosen according to the in-situ soil). Regularly shaped stones allow the mason to achieve adequate bonding in all directions.

Stones must be free of dust and dirt. It is therefore advisable to wash them and, if necessary, clean them with a brush.

### 9.4.4 WEEP HOLES

For retaining walls, it is important to add at regular intervals (approximately every 1.5 metres) weep holes which allow water that collects behind the wall to drain off. The weep holes should be placed about 200 to 300 mm above the existing ground level. Weep holes can be made of short plastic pipes or simply by constructing small holes in walls. In remote areas banana or similar stems can be used to form the holes during construction after which they can be easily removed once the mortar has cured.

## 9.5 BRICK AND BLOCK MASONRY WORKS

### 9.5.1 FOUNDATIONS

Foundations for Load bearing walls are usually made of reinforced concrete and need to be appropriately designed and specified in the contract specifications and drawings. See Figure 9-3.

Figure 9-3: Typical Brick Foundation

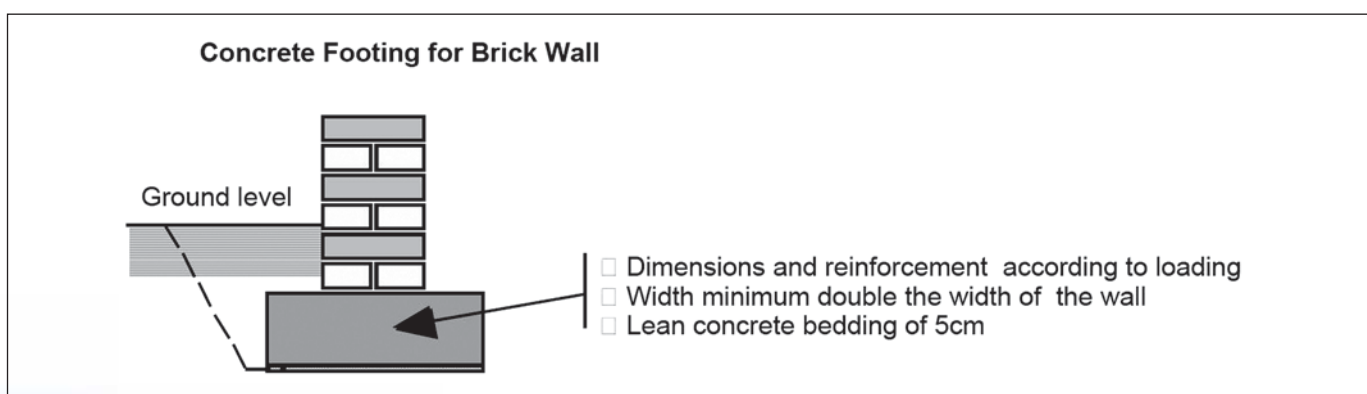

For minor walls which do not support a heavy weight, foundations (footings) can also be made with bricks or blocks and serve the same purpose as concrete foundations:

- depth underground = minimum 40cm, on firm uniform ground;
- 5cm lean concrete (1 : 4 : 8) as a base.

As a rule of thumb, brick or block foundations should be twice as wide as the actual wall thickness on the lowest wall course. Each course of the foundation is reduced in regular 1/4 offsets on each side until the actual wall thickness is reached. See Figure 9-4.

Figure 9-4: Brick Footing in Flemish Bond

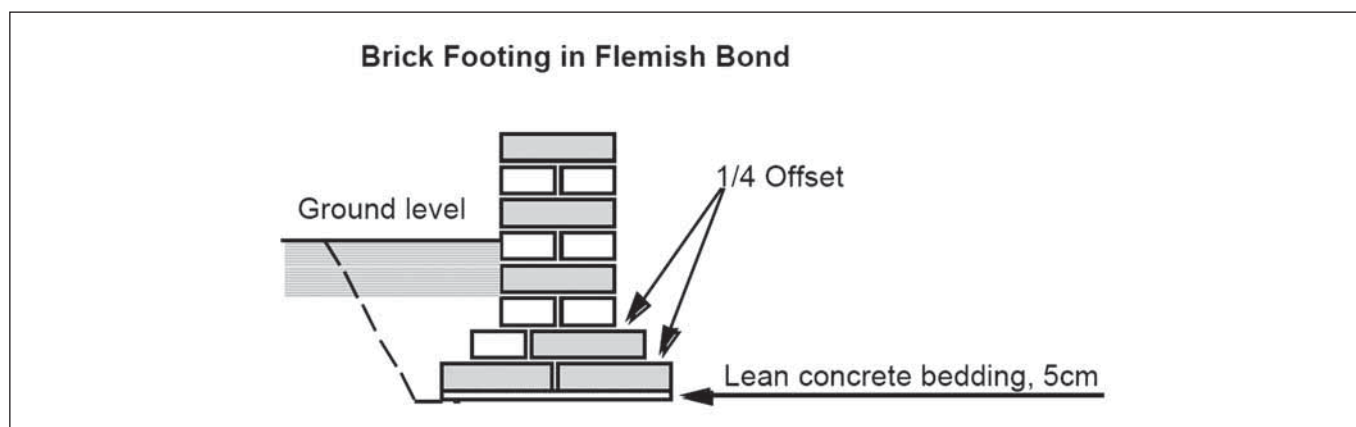

### 9.5.2 JOINTS

Joints in brickwork shall be as follows:

- for brick masonry = 1.2cm to 1.5cm;
- for shaped stone masonry = 1.2cm to 2.0cm.

### 9.5.3 TYPE OF BOND

Bricks can be laid in very many different bonds. However, whatever type of bond is employed it must be practical and easy to construct.

Only good quality bricks as specified should be employed for infrastructure works. They should preferably, be from the same manufacturer. The differences of the measurements should be kept to a minimum (tolerance plus/minus 1mm per brick). Bricks must be well watered before use. Bricks with cracks must be rejected.

Basically there are two types of walls that can be encountered in infrastructure works namely, solid walls or cavity walls. Solid walls consist of one or more leafs of bricks or blocks (also known as wythes) adjacent to each other separated by mortar. Cavity walls consist of two walls separated by a cavity. The two walls can each be one leaf or more whilst the cavities normally range from 50mm to 115mm in width.

However, in this guideline focuses on single and double leaf walls which are commonly used in minor works. Indicative figures for constructing single and double leaf walls are given in Table 9-6 below.

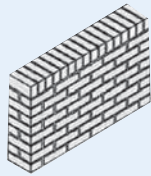
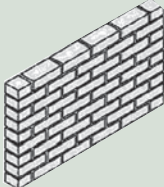

**Table 9-6: Quantities for Standard Bricks**

Type of Wall	Material	Quantity* per m <sup>2</sup>	Task Rate**
Single Leaf (half brick wall) 	Bricks Sand Cement	55 Nos. 0.04 m <sup>3</sup> 0.18 bags	685 common (stock) bricks per day or 450 face bricks per day
Double Leaf (one brick wall) 	Bricks Sand Cement	110 Nos. 0.08 m <sup>3</sup> 0.36 bags	

\*It is recommended for purposes of adequate estimation, pricing and procurement that 5% additional quantities be allowed for wastage and breakages.

\*\* Source: CIDB; Assume 1 Brick layer works with 2 General Workers

Typical types of bonds which are commonly used worldwide are also shown below.

**Box 9-2: Brick Terminology and Types of Bonds**

**Terminology**

**Typical terminology used in brickworks**

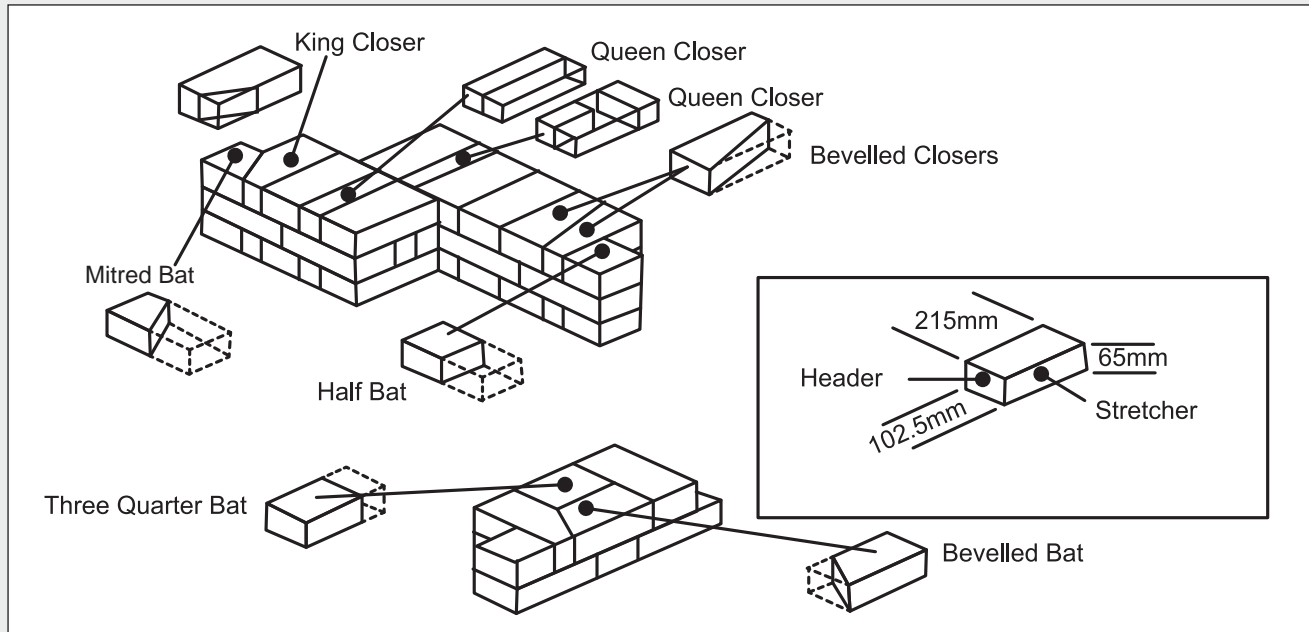

**English Bond**

This bond has headers and stretchers in alternate courses, with a closer placed next to the quoin header to form the quarter lap (quoin = corner), or alternately a three - quarter bat can be placed at the quoin but only in the stretcher course. This is a very strong bond, with no straight joints appearing in any part of the wall. The face of the wall is monotonous to look at, and hence it is normally used in walls where strength is preferable to appearance and always used in conjunction with engineering bricks.

**English Bond**

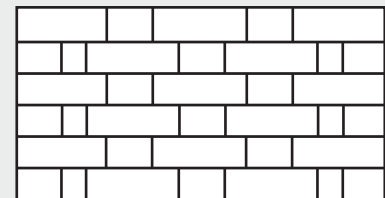

**Stretcher Bond**

A pattern made using only stretchers, with the joints in each row (or course) centred on the bricks in the row below. Not structurally strong or aesthetically interesting, but very common. It is often used for curtain walls one brick thick.

**Stretcher Bond**

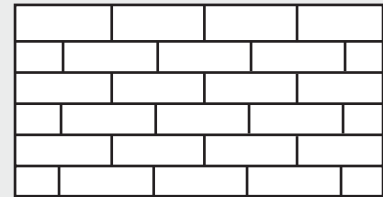

**Flemish Bond**

This consists of alternate headers and stretchers in the same course with the headers in one course being placed centrally over the stretcher in the course below. A closer is placed next to the quoin header to form the quarter brick lap. Flemish bond is used in walls of a decorative nature where strength is not important, as there are internal straight joints of a quarter - brick in length which appear at intervals along the wall.

**Flemish Bond**

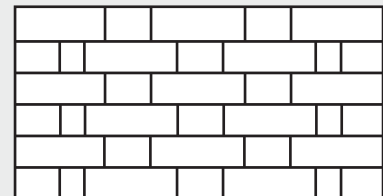

**Header Bond**

This is used in walls curved on plan. It consists of full bricks laid header-wise with a three - quarter bat on alternate courses or if you have a tight curve in a one brick thick wall you can use snapped headers on either side of the wall (snapped = half).

**Header Bond**

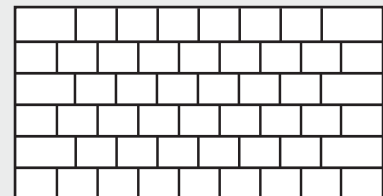

Unless otherwise specified the English Bond shall be used.

**9.6 PLASTERING**

Plasterwork refers to construction or ornamentation done with plaster, such as a layer of plaster on an interior wall or plaster decorative mouldings on ceilings or walls. Plastering aims at giving the wall an even surface which can then be painted. Builder' sand-cement plaster is the most common whilst gypsum based plasters may also be used for internal plastering. The plastering guide published by the Cement and Concrete Institute (South Africa) is reproduced herein and attached in the Appendices. It is a useful guide for contractors and project Supervisors.

The following Box 9-3 below gives productivities of plasterers for horizontal and vertical surfaces. Assume the Plasterer is working with two general workers.

**Box 9-3: Productivity for Plastering**

One Plasterer can plaster 22.5 m<sup>2</sup>/day per coat to horizontal surfaces  
 One Plasterer can plaster 31.5 m<sup>2</sup>/day per coat to vertical surfaces

Source: CIDB

**9.7 PAINTING**

The primary functions of paint are to provide protection to constructed materials and components economical and at the same time (in particular for buildings) providing surface decoration to the painted surfaces. Paints are complex chemicals with their composition varying depending on the type and manufacturer<sup>20</sup>.

<sup>20</sup> Wikipedia



The basic components of paint are a binder, pigment and solvents. The binder is the liquid component up to form the surface film. It may compose of linseed oil, drying oils, synthetic resins and water. Its purpose is spread the paint and bind the pigment. The pigment on the other hand provides the body, colour, durability and corrosion properties of the paint. Lead pigments are poisonous and paints which contain them should be avoided or used with extreme care. Titanium Dioxide is an acceptable alternative pigment and is not poisonous. Solvents and thinners may be added to paint in order to alter its viscosity<sup>21</sup>.

### 9.7.1 DIFFERENT TYPES AND CHARACTERISTICS OF PAINTS

Although there are many types of paint in the market, the most common types are Oil Based and Water Based Paints. Oil based paints are used for priming, as undercoats and for finishing and they are suitable for most applications if used appropriately with primers and undercoats. Finishing grades are available in a wide range of colours and provide a wide range of finishes such as matt, semi-matt, eggshell, satin, gloss and enamel finishes. Polyurethane paints have a good hardness and are resistant to water and cleaning.

Water based paints are usually emulsion paints. The finishes for these paints are achieved by adding water medium additives such as alkyd resin and Polyvinyl Acetate (PVA). Finishes include matt, eggshell, semi-gloss and gloss. These paints are quick drying and available with a washable finish. They are suitable for most applications.

Water based paints have low proportions of volatile organic compounds and are thus more environmentally friendly. They are also washable with soap and water thus reducing hazardous waste generation. However, these paints corrode steel and aluminium and thus should not be used on these surfaces. They also have lower solvent and temperature resistance thus they should not be used in constantly wet areas or areas with high temperatures such as boiler rooms, furnaces and the like. At low humidity water based paints dry too fast resulting in uneven surfaces whilst at high humidity they dry too slowly resulting in sagging.

### 9.7.2 PAINT APPLICATION

Paint can be applied to most surfaces provided the receiving surface is properly prepared, proper sequence of paint coats is followed and the suitable type of paint is used for the job.

**Surface Preparation:** It is of critical importance that the receiving surface is properly prepared since most failures can be traced to poorly prepared surfaces. All dirt, grease, dust should be removed from the receiving surface. The final surface should provide an adequate key for the paint.

For Timber to receive paint it should be dry with a moisture content of less than 18%. The timber surface should be sand papered to produce a smooth surface brushed and cleaned of all dust. Grease should be removed with a suitable solvent. Knots should be sealed with two coats of alcohol based resin called knotting or cut out and replaced with sound timber. After priming cracks and fixing holes should be sealed with putty or appropriate filler. Each paint coat must be allowed to dry hard and be sanded with a fine sand paper before applying the next coat.

Iron and Steel surfaces should wire brushed to ensure that they are free of all rust, mill scales, oils, grease or wax. For large scale projects mechanical means such as sand blasting, flame cleaning or chemical processes should be considered.

Plaster surfaces should be dry, smooth and free of defects before any paint is applied. Plasters which contain lime should be treated with an alkaline resistant primer when dry before applying the paint.

<sup>21</sup> Building Construction Handbook, R. Chudley & R. Greeno, 1999

**Priming Coats:** should be used on unpainted surfaces in order to obtain the necessary adhesion and to inhibit corrosion of steel surfaces.

**Undercoats:** are applied on top of primers after all defects have been made good as necessary.

**Finish:** is applied in one or more coats over the undercoat to impart the required finish and colour.

### 9.7.3 PAINTING TOOLS

Tools for painting are general widely available. When using water based paints the tools used should be resistant to water corrosion thus steel based tools should be avoided when using these paints.

The brushes used should be to specification. Compressed air sprays or airless sprays can be used for large projects. Rollers of width 50mm to 450mm can be used for flat and textured surfaces. All tools should be thoroughly cleaned after use.

### 9.7.4 ESTIMATING PAINT QUANTITIES

The covering capacity of paint is dependent on the quality of paint, the type of surface to be painted, skill of the painter, the weather and so on. The Manufacturer for each type of paint will specify a Theoretical Spread Rate (TSR) which is the area that a litre of paint will cover. However, the TSR is calculated based on a paint being applied on a smooth surface such as smooth plaster or a smooth steel surface. Therefore, in order to make accurate estimates of quantities the TSR should be adjusted based on experience so as to compute the quantities accurately.

If a Manufacturer specifies a TSR of 10m<sup>2</sup>/litre and you need to paint 140m<sup>2</sup>, the theoretical volume of paint required will be:

$$\frac{140 \text{ m}^2}{10 \text{ m}^2/l} = 14 \text{ l}$$

However, from your experience if you authoritatively know that for the type of surface you want to paint the effective Spread Rate is 7m<sup>2</sup>/litre, it is advisable that you use this rate and order 20 litres and further allow an extra 5 to 10% for spillages.

### 9.7.5 PAINTER PRODUCTIVITIES

It is not easy to give a global guide for paint tasks. However, as a general guide a Painter can paint a single coat of between 60m<sup>2</sup> to 80m<sup>2</sup> of walls per day. For new metal surfaces a painter can complete up to 90m<sup>2</sup> per day but for decorative or specialist paintwork such as doors and window frames a skilled painter may complete 20m<sup>2</sup> of work. The following guide is recommended by CIDB in South Africa.

**Table 9-7: Productivity for Painting**

Description	Productivity
Undercoat and two coats paint to walls	37.8 m <sup>2</sup> /day
Undercoat and two coats paint to ceilings	30.6 m <sup>2</sup> /day
Two coats varnish to wood	32.4 m <sup>2</sup> /day
Prime, first coat and two coats enamel to surfaces	32.4 m <sup>2</sup> /day

Source: CIDB. Assume each painter works with one unskilled worker.



## 10. SITE ADMINISTRATION AND WORK ORGANISATION

### 10.1 SETTING UP A CAMP

Before construction commences, a site camp needs to be set up to accommodate the supervisors, workers, materials, tools and equipment. The site camp needs careful planning to provide site staff with a basic comfort, and adequate storage and security for equipment and materials.

#### 10.1.1 LOCATION

The selection of a suitable camp location should be made by the Site Agent or supervisor and the following issues should be taken into consideration:

- it should be close to the construction site as far as is possible, preferably in walking distance,
- it should have access to drinking water,
- it should be located on high, well-drained land,
- it should have sufficient space for parking equipment after working hours, and
- it should be easily accessible to project vehicles bringing equipment and materials.

The size of the camp depends on the size of your project, what type of works you are carrying out and how far you are from the head Office.

In most cases, the site camp can be set up in the local village where all or part of the works are to be constructed. Then, suitable accommodation and stores can be rented from the local villagers. In more remote places, the entire site needs to be established by the project.

Standard requirements for a site camp are:

- accommodation for the supervisors and equipment operators,
- a site office,
- a site store,
- appropriate cooking facilities,
- ablution facilities (separate for females and male),
- extra site store for fuel, oil and lubricants, and
- Security Fencing.

#### 10.1.2 SITE SUPERVISORY STAFF

A Trained supervisor, responsible for a site, is usually capable of effectively controlling a labour force of 100 to 150 workers. Gangs (some authors refer to them as Crews), formed for the different operations, normally range from 5 to 25 workers, depending on the nature and amount of work to be carried out. Among the workers in each gang, one person should be appointed their leader, normally referred to as the Gang leader. This person will receive the work instructions from the site supervisor and hand them on to the workers in his/her gang. The Gang Leaders support the site supervisor in coordination and supervision.

It is good practice to allow the gangs work on the same operation for longer periods to enable to master skills on the tasks they are assigned to. This will improve productivity on site and ensure the work gain marketable skills which will be beneficial to them beyond the project period.

#### 10.1.3 LABOUR RECRUITMENT

Normally, labour is recruited from the villages in the vicinity of the works within a walking distance of 5km. However, in some cases, the works may be located in very remote areas where there is a limited supply of labour. In such cases provision should be made for daily transportation of workers, or workers need to be housed on site. Unless local





housing is available for the migrant labour, this will require a considerably larger camp. In such a situation, temporary dwellings and proper sanitation facilities needs to be erected at the camp. In addition, arrangements need to be made so that the workers have regular access to grocers and markets.

Obviously, this is a more expensive solution to labour recruitment and should be avoided if possible.

Figure 10-1: Labour recruitment in Mt. Elgon, Uganda



## 10.2 SITE SUPPORT ACTIVITIES

### 10.2.1 DRINKING WATER

People who are carrying out physical work and exposed to elements need to drink a lot of water to prevent dehydration. It is therefore important for the workers to have water available on the work site. If there is no potable water within the vicinity of their job site, some arrangement should be made to supply and store water for drinking purposes. This normally implies that it is necessary to engage a couple of workers to transport clean water to the work site and the camp.

The amount of drinking water required varies with the weather conditions, but a minimum of 3 litres per person per day should be provided.

### 10.2.2 FIRST AID

Every site should have access to a first aid medical kit(s) commensurate with the size and spread of the workforce. The medical kit should be administered by someone who is properly trained in using its contents. The first aid kit should be regularly replenished, so it is effective when an accident occurs. However, dispensing of medications is not recommended, workers with serious ailments should be transported to the nearest Health centre for proper medical care.

Figure 10-2: First Aid Officer on site



### 10.3 WORK ORGANIZATION

Work programming is to arrange and distribute the construction works between the gangs of workers in such a way that the most economic use is made of the available labour, material, tools and equipment. This includes planning the works, taking the following items into account:

- in which order work operations and activities should follow, the construction sequence,
- the numbers of workers in each group, i.e. gang size and balancing,
- how to motivate the labour, using incentives, such as task work, and
- how instructions are given and received in an efficient manner, avoiding misunderstandings and incorrectly executed works.

Figure 10-3: Poorly organized site



Figure 10-4: Well organized site



### 10.3.1 WORK PROGRAMMING

#### Construction Sequence

Once the site camp has been established and supplied with materials, tools and equipment, construction works can commence.

Infrastructure construction works are divided into a number of operations, each sub-divided into a series of activities. The separate operations on a construction site have to follow each other in a logical sequence.



For example in pipe laying, works should follow the sequence as shown in Table 10-1 below:

Table 10-1: Pipe Laying Construction Sequence

Operation	Activities
<b>Establishment and Support Activities</b>	Procurement of Tools and Equipment Work at the Site Camp Preliminary Setting Out
<b>Setting Out</b>	Detailed Setting Out
<b>Clearing</b>	Bush clearing Grubbing Tree and stump removal Boulder removal
<b>Earthworks</b>	Excavation
<b>Pipe Bedding</b>	Select Material from excavated material, Procure from Rivers/Borrow Pits/ Commercial Sources, place and compact bedding material
<b>Pipe Laying</b>	Procure, Transport, Unload, place along trench and lay pipes
<b>Earthworks</b>	Partial Backfilling
<b>Pipe Testing</b>	Testing to Specification
<b>Earthworks</b>	Backfilling
<b>Earthworks</b>	Disposal of excess material: Loading, Haulage, Unloading

Normally, each activity is carried out by a separate group of workers. Pipe Bedding and Laying can be undertaken by one gang under the supervision of a Skilled Pipe/Drain Layer. If the activities are not properly planned and are too close to each other, the work might be disrupted (e.g. an excavation gang might have to wait for a clearing gang to finish). On the other hand, when activities are spaced too far apart, the length to supervise will become unnecessarily long.

When commencing on a new project, it is important to stagger the above operations, allowing sufficient time gaps before starting the next operation. This will also allow the supervisor to organise the work properly and give basic instructions and training to the newly recruited labour.

### 10.3.2 DAILY WORK PLANNING

A supervisor must always plan ahead by at least one day. After the workers have completed their daily work, the supervisor records the outputs achieved on each of the activities. Based on the production achieved and the overall plan for the project, a plan for the following day is prepared. This plan sets the daily production targets for each of the planned activities.

To prepare these work plans properly, the supervisor needs to know what has happened on the site before. Without information such as what resources were needed to produce a given output, why certain targets were not met, etc., proper planning is impossible. To get the right information on time, a well-functioning reporting system is required.

### 10.3.3 GANG BALANCING

Balancing of gang sizes, i.e. ensuring that the labour is used in the most efficient way, and that each of the operations on average proceeds at the same pace, is the daily task of the site supervisor.

Good gang balancing is important because it also determines the coverage of the construction site. If the gangs are not well balanced, the result may be that the work site spreads out and becomes too large to supervise in an efficient manner, or that it becomes too concentrated and the workers are working in a small and congested area thus interfering with each other.

The amount of work will vary from location to location on the project. Therefore there will be a demand for adjusting the number of workers in each gang. An example of typical gang balancing is given in Box 10-1 below.

**Box 10-1: Practical Gang Balancing**

On Section A of a proposed pipeline, there is a lot of bush clearing and very shallow (0.7m deep) soft excavation needed, and on the following Section B there is limited amount of clearing but heavy excavation works. This implies that after clearing and earthworks have been completed on Section A, a number of workers needs to be transferred from the clearing gang to the earthworks gang. If this is not done, the clearing gang will advance too fast and the earthworks operation will proceed too slowly on Section B - resulting in a stretched work site which may become difficult to supervise.

Details of the portions of work:

Description	Units	Section A	Section B
Length	m	50	50
Type of Clearing		Thick	Light
Volume of Clearing	m <sup>2</sup>	150	150
Clearing Task Rate	m <sup>2</sup> /wd	100	350
Pipe Diameter	mm	160	160
Trench Width	mm	760	760
Pipe laying task Rate	m/wd	2.7	2.7
Mean Depth	mm	700	1500
Type of Excavation		Soft	Medium
Excavation Task Rate	m <sup>3</sup> /wd	5	3.5
Backfilling Task Rate	m <sup>3</sup> /wd	4	4

Assuming you have the following Gangs:

- Clearing Gang
- Excavation Gang
- Pipe Laying Gang
- Backfilling Gang

If Each Gang has to complete the portions of work in one Day what are the gang sizes required for each portion of work?

For Section A:

Clearing

$$\text{Number of Workers} = 150\text{m}^2 \div (100 \text{ m}^2/\text{wd} \times 1\text{d}) = 1.5 \text{ workers}$$

2 workers can be assigned to the task with one working a full day whilst the other will be reassigned after half the day.

Excavation

$$\begin{aligned} \text{Number of Workers} &= (50\text{m} \times 0.76\text{m} \times 0.76\text{m}) \div (5 \text{ m}^3/\text{wd} \times 1\text{d}) \\ &= 26.6 \text{ m}^3 \div (4 \text{ m}^3/\text{wd} \times 1\text{d}) \\ &= 6.7 \text{ workers} \\ &= 7 \text{ (rounded off to whole number)} \end{aligned}$$

7 workers can assigned to the task with five working a full day whilst one will be reassigned after half the day and so on.



So for work to proceed smoothly the gang sizes shall be as below when rounded off to next whole number.

Description	Gang Size for	
	Section A	Section B
Clearing	2	1
Excavation	6	17
Pipe laying	19	19
Backfilling	8	18

We have allowed for 20% bulking when backfilling.

### 10.4 WORKER'S REMUNERATION AND INCENTIVE SCHEMES

Payment of works can be organised in various forms, depending on the nature of work and type of funding. It is necessary to investigate which incentives can be used and which systems will be the most effective. Also, the workers have to understand and support the system which is introduced. If the system is not regarded as fair, the workers will cease to turn up to work.

#### 10.4.1 DAILY PAID WORK

Daily paid workers are paid a fixed sum for each day in return for a fixed number of working hours regardless of his/her work outputs. This system is often used when starting up a new project before an incentive scheme has been established. It is also used as the basis payment when productivities are low and the limits for the receipt of bonuses are not reached. This payment system is applied for most site support activities, such as store keeping, the watchman and provision drinking water.

#### 10.4.2 TASK WORK

It is a system of work whereby a fixed daily wage is paid to a worker in return for a fixed quantity of work completed within about 5 ~ 6 hours. The worker(s) is/are free to go home as soon as the set quantity of work has been completed and approved. Tasks can be given to individuals or to groups of workers. Production is assured as payment is made only upon production. This system requires close supervision and monitoring in the daily laying out of work, overall setting of task size, checking and approving the work.

#### 10.4.3 PIECE WORK

In this system, the worker is paid a fixed sum per unit of output. The worker is thus paid on the basis of small quantities or pieces of output. There is no reference made to the amount of time it takes to accomplish one piece. The daily output is left to the discretion of the worker, who can thus increase his daily earnings by producing more. This system requires good control and flexible payment conditions and is therefore favoured and suitable for private employers. There is however, the tendency for self-exploitation as no limit is placed on the amount of work a worker can do. It is thus difficult for a public body or in large projects to effectively manage such a system.

#### 10.4.4 OTHER FORMS OF PAYMENT

In areas where food supply is limited, payment in the form of say food parcels may act as an effective incentive. However, there are certain international standards which must be observed when paying with food for work. Unless the Government declares an emergency situation in the area, the food payment should be combined with a certain minimum amount paid in cash. In general however, this system of remuneration needs careful Policy consideration before implementation.

## 10.5 TASK RATES

To be effective and fair, the tasks must be estimated correctly and set out properly. The supervisor therefore needs to know in detail how to set out task work and which task rates to use for the various activities in different circumstances (hard or loose soil, wet or dry soils, thick or sparse bush, etc.).

Task rates or piece rates can be set on most activities. In general, it is better to set a lower task rate rather than organising the workers on daily paid work. For instance the following activities may be organised as task work:

- Grass and topsoil removal (grubbing)
- Excavation and backfilling/compacting
- Pipe Bedding
- Culvert laying
- Loading
- Hauling for short distances
- Unloading
- Spreading

It is the responsibility of the site supervisor to calculate and set the task. For this, it is necessary to establish (i) the quantity of works (area, volume or numbers) and (ii) the difficulty of the work (loose or hard soil, etc.)

The correct amount of work one worker has to complete in one day, has to be established by detailed measurements of productivity under various conditions. For this, the daily and weekly reporting system will provide good support for the supervisor. When a new site is established, it may initially be necessary to organise some of the work on a daily paid basis. Based on the productivities during the first couple of weeks, it is possible to establish and refine the task rates on the work site.

A correct set task should allow the average worker to finish their day's work in approximately 75% of the normal working hours.

It is the responsibility of the site supervisor to ensure that the workers receive their tasks in the morning immediately when they arrive, and that the amount of work is fair and just. The size of the task must therefore be carefully monitored to ensure that the amount of work given to each worker is neither too little, nor too much. The task rates given in this document are given as a guide and should ideally be adjusted to suit peculiar conditions of each particular site.

The setting out task should be done one day earlier so as to minimise delays in the following day.

## 10.6 INSPECTION AND SUPERVISION

Giving and receiving instructions is a major part of the responsibilities of the site supervisor. The manner in which instructions are given influence the manner in which they will be carried out. Before instructions are given, it is important to specifically know:

- What work needs to be done,
- How it should be carried out,
- Who will do it, and
- the difficulties involved in doing it.

Instructions can be given either directly to the person who will carry out the work, or indirectly through a gang leader. Direct instructions to all concerned workers including their gang leader should be used as much as possible. Indirect instructions can be given through a gang leader when he/she as well as the workers are familiar with the task and the work methods. Questions should be asked to check whether the instructions given have been understood.



If the work is not familiar, careful attention must be given to explaining the work in detail to the entire gang. In many cases, it would be useful for the supervisor to actually demonstrate the work and how it is properly done.

Whenever practical, instructions should be given in writing or written down when received. This applies in particular to instructions concerning measurements and technical designs.

### 10.6.1 QUALITY CONTROL

The supervisor needs to inspect and approve the work before the workers are released for the day. On receiving notification from the gang leaders on the completion of a certain task, the supervisor shall inspect and certify the works.

If the work has been satisfactorily completed, the group or individual may be released for the day. If the work is not complete, it should be corrected before the group or individual worker is allowed to leave the site.

If the task is not completed before the end of the normal working day (maximum of eight hours), the supervisor needs to find out the cause of the delay - whether the cause lies with the workers or with his/her own setting of the task. If the reason for non-completion is one of the following, the workers should be released:

- major difficulties not considered when the task was set (i.e. heavy roots, big rocks, etc.),
- incorrect measurement or calculation of the task,
- smaller work force than ordered (if a group task was set),
- bad weather conditions during parts of the day.

Support gang should be engaged the following day to complete the unfinished work. If the reason for non-completion lies with the workers, they should complete the task before being released.

## 10.7 REPORTING

Global experience in Employment Intensive projects can reveal that

- Planning and reporting procedures are often not:
  - o adapted for effective use by the private sector;
  - o well designed and standardized;
  - o informative and comprehensive on essential issues;
  - o targeted for action and feedback by the appropriate manager;
  - o given due importance;
  - o produced in due time;
- Computerized systems can make planning and reporting of basic facts/statistics simple and interactive, producing summarized information for management action. Initially, however, computerized systems should be introduced with great caution and backed up with a functioning manual system;
- Serious omissions (e.g. failure to report costs, state and utilization of equipment) often deny project managers vital inputs for decision making;
- The importance of good planning, monitoring and reporting as a primary function of effective management tends to be underestimated.

The Table below suggests reporting mechanisms for Implementing Agencies and Contractors involved in Employment Intensive projects:

Table 10-2: Reporting Mechanisms

General planning and reporting systems	Contractor's internal system	Government Department/Municipality/ Contracting agency's system
Daily	<ul style="list-style-type: none"> <li>• Resource use:                             <ul style="list-style-type: none"> <li>- Muster roll</li> <li>- equipment</li> </ul> </li> <li>• Materials</li> <li>• Tasks</li> <li>• Planned and actual outputs</li> <li>• Problems on site</li> </ul>	<ul style="list-style-type: none"> <li>• Daily site diary</li> <li>• Daily site record of works</li> </ul>
Weekly	<ul style="list-style-type: none"> <li>• Resource use:                             <ul style="list-style-type: none"> <li>- equipment</li> <li>- materials</li> </ul> </li> <li>• Planned and actual outputs</li> <li>• Costs</li> <li>• Problems on site</li> <li>• Forecasts</li> </ul>	<ul style="list-style-type: none"> <li>• Record of site instructions</li> <li>• Weekly works measurements</li> <li>• Inspection reports</li> </ul>
Monthly	<ul style="list-style-type: none"> <li>• Resource use:                             <ul style="list-style-type: none"> <li>- equipment</li> <li>- materials</li> </ul> </li> <li>• Planned and actual outputs</li> <li>• Costs</li> <li>• Problems on site</li> <li>• Forecasts</li> </ul>	<ul style="list-style-type: none"> <li>• From site to management:                             <ul style="list-style-type: none"> <li>- progress</li> <li>- statistics</li> <li>- financial</li> <li>- problems</li> <li>- forecasts</li> </ul> </li> <li>• Abridged Reports to senior management</li> </ul>
Quarterly / yearly		From management to government departments and external funding agencies: <ul style="list-style-type: none"> <li>• Summary progress report                             <ul style="list-style-type: none"> <li>- Financial report</li> <li>- Technical and Physical Progress</li> <li>- Plan of operations</li> <li>- Reviews /evaluations / studies</li> </ul> </li> </ul>

Source: ILO

Box 10-2 below outlines current practice from South Africa in the implementation of the Expanded Public Works Programme.

**Box 10-2: South African Experience in EPWP**

**Project Structures**

The table below provides a summary of structures to be put in place for efficient implementation of EPWP/LIC project:

Arrangements/Structures	Steps to follow
Establishment of a vibrant Project Steering Committee to oversee the project and ensure workers' welfare	Stakeholder Identification and Communication Strategy Conducting Community Awareness Campaigns Identify and establish Project Steering Committee(s) (PSC) in project areas
Providing an induction course at the beginning of project to the workers which should cover the following:	Induction process should entail Brief on Labour Intensive Construction methods and the activities to be undertaken by the workers on the project Task work system and its advantages to the workers Applicable Daily wage rate on the project and mode of payment Conditions of worker's employment including disciplinary procedures





Arrangements/Structures	Steps to follow
Establishment of a transparent recruitment procedures	
Provision of Workers' Employment contracts which details all terms of employment.	<ul style="list-style-type: none"> <li>Application of fair task work rates</li> <li>Provision of good quality handtools, requisite protective clothing and ensuring safety on site</li> <li>Ensuring prompt/timely payment to workers</li> <li>Establishment of clear disciplinary procedures</li> </ul>

**STAKEHOLDER IDENTIFICATION AND COMMUNICATION STRATEGY**

Consultation and participation of all key stakeholders is essential for successful implementation of LIC projects which are mostly community-based programmes.

Prior to commencement of the Project, it is important to identify the key local stakeholders who need to participate in the project implementation and with whom the client of the Project, consultants and contractors need to interact. Key stakeholders should include amongst others, the relevant local government, traditional leaders, development forums, community structures and representatives.

The process of identifying stakeholders needs to follow a participatory process. One of the key activities is to conduct a Rapid Rural Appraisal, i.e. a process of learning about community conditions and dynamics in an interactive manner following a systematic approach that is designed to draw inferences, conclusions, hypothesis and assessments within a limited period of time.

Community Awareness exercise can be undertaken by facilitating briefing meetings and conducting workshops to ensure stakeholders and the general publics' understanding of programme background and objectives, scope of work, impact, benefits, and Client's policies and principles for project implementation, and their different roles and responsibilities. Communication strategy should also be established whereby different stakeholders are involved in the programme and receive the necessary information in order to fully participate in decision-making.

**ROLE OF PROJECT STEERING COMMITTEE(S) (PSC)**

The PSC will represent the beneficiary community on the project. The PSC enables stakeholder participation, in particular the community and the client, in various planning, managing and decision-making processes through the detailed design and implementation phases of the project. The PSC may be a temporary structure that ceases to exist once the project is implemented. Since the PSC is or might be a temporary body, it is important that it does not become the focus of all capacity building and training efforts. Thus PSC capacity building and training should be limited to the specific roles and responsibilities outlined in the Terms of Reference (TOR) for PSC.

**ADOPT A TRANSPARENT LABOURERS' RECRUITMENT PROCEDURE**

Whenever there is a need to recruit labourers at any of the Client Body's EPWP project sites, the following guidelines are recommended to be followed to ensure transparency and equitable distribution of employment in the project area:

Contractor signs contract with Client Body for a construction work to be done which among others specifies the number of workers required.

The client Body writes a letter or through an appointed Social Facilitator (e.g. IDT or private Social Consultants), coordinates a meeting with the district and the local municipality to inform them about the project to be carried out by contractors in the district.

Local community, through all structures available including the local administration are informed and consulted about the establishment of the EPWP project. The Project Steering Committee (PSC) is established.

The PSC makes an announcement of workers required from relevant communities within the project corridor. The recruitment of the workers is announced at least a month in advance using appropriate community structures.

Notice of recruitment is placed in public places within the community and announcements are made in all community gatherings, events and meetings e.g. funerals, burial clubs, schools, churches, tribal meetings, cultural events, etc.

The recruitment notice should specifically state the following requirements:

- Villages where the recruits would come from within a radius of 5km of the project area.
- Target group
- Recruitment date and venue
- Number of workers needed.
- Recruitment requirement e.g. positive identification ID
- Exclusion criteria

The following people should be present to witness the recruitment:

- Client Body representative;
- Social Consultants (IDT, or private);
- Project Steering Committee and;
- The Contractor.

The community representatives and residents should be informed about the recruitment procedures and are to be assisted to understand them clearly.

Members of the community who are economically active are given an opportunity to apply for work. A roster of all interested and eligible workers is prepared and distributed to the Contractor and Project Steering Committee.

The Contractor is required to make maximum possible use of the local labour force from the communities where the project is being implemented. Communities in this regard refer to all the surrounding villages or settlements or any group of people living within a radius of 8km from the project location.

**Local labour** is defined as people who reside in the community within the project area who have been identified and selected to be workers in this programme.

**Key personnel** are defined as foremen and skilled labourers of the contractor, without whom the particular job could not be accomplished. As far as possible these people should impart their skills to individuals within the community workforce who show a keen interest and display a willingness to learn. (The use on non-local labour should where possible be limited to key personnel only.)

## RECRUITMENT PROCEDURE

The recruitment of the workers will basically be implemented as follows:

- (i) A general list of all individuals willing to work on the project is prepared per village and submitted to the PSC as well as the contractor. The PSC and contractor go through the list and ensure that each individual meets the preference requirements of the EPWP. The targeted gender composition in this programme is: Female = 40%; Male = 60%. It is also recommended that from the gender balance above, 30% comprises of Youth (18-35) and, 2% Disabled.
- (ii) The required number of workers is then selected using ballot system from amongst the able-bodied people.

After the selection, each labourer should be issued a personal Employment Form in duplicate, one copy is to be given to the labourer and the other copy is to be retained by the contractor as a copy for reference. It may not be possible to call all the labourers to start work as from the first day of operations. They will have to be engaged



and disengaged in according to the contractor's approved planned work sequence. The workers should also each be issued with a Certificate of Service on their successful completion of the project.

### **CONTRACTOR'S STAFF AND LABOUR WELFARE**

Labour Intensive projects normally employ large labour forces, whether executed by Contractors or by force account. In this situation there is always a danger of exploitation of the labour force and could be counter-productive in the long run. Contractors may not see the advantages of good labour- and staff management because the benefits are difficult to quantify and do not appear directly on the balance sheet. The most fundamental management principle that must be adhered to in all EPWP projects is prompt payment of fair labour wages. Other welfare issues which must also be well taken care of are:

- a) Issue of good quality tools,
- b) Provision of protective clothing, goggles etc. when needed and
- c) Provision of first-aid kits, medicines etc. on site,

All of the above are the Contractors' responsibilities.

Protection of the labour force and staff against exploitation should be of equal concern for the Project management and local leaders in the municipalities where the projects are operating, as it is for the Consultants, Project Managers or Contractors. Short of forming Trade Unions for casual labour, which would not be feasible, the recommendations above institute proper representation of labourers and staff to pursue matters of concern for their own welfare. It is equally important that all parties understand the dual interests and responsibilities they share for the productive implementation of EPWP labour intensive projects.

The appointment of Community Liaison Officer (CLO) is the first control mechanism put in place to guard against such exploitation of workers. The CLO monitors the welfare of worker reports regularly on the same. The CLO also countersigns on Contractors' Monthly Salary and Wages Returns and submits his/her Workers' Welfare Report on a monthly basis.

## 11. CONSTRUCTION HAND TOOLS AND EQUIPMENT

### 11.1 SPECIFICATION FOR TOOLS

In labour-based infrastructure works, handtools are used to produce the same results as heavy Capital Equipment does in equipment-based works. It is therefore important to select and maintain your tools properly.

It is therefore important to use and maintain the tools properly. All Senior Site Personnel must be aware of this in order to be able to instruct the labourers accordingly. Even if the handtools are readily available in the local market, it is advisable that tools employed in labour-based works be made to a recommended basic standard. A minimum selection criteria framework should be adopted by every contractor. The choice of correct and good quality handtools allows higher productivity, while cheap handtools will, although saving some money initially, reduce your productivity in the long run and need to be replaced in a shorter period which likely leads to lower profits.

It is also worth considering that the overall cost of handtools is small compared to the labour cost. The cost of a shovel often equals something like five days' wages of a labourer. If you assume that a good quality tool lasts for 6 months of heavy-duty work, the cost represents only 3 ~ 4 per cent of the labour cost. However, the condition of your handtools strongly influences the productivity your labourers can achieve. If the labourers have to use tools that are not suitable, or are worn out, they cannot produce as much as they could with tools in good condition (in many cases you have only half the productivity if the tools are in bad condition). Considering that profit depends on productivity, it is easy to see the strong economic argument for ensuring that your labourers have access to appropriate quality tools.

Allocating additional resources when buying high quality tools usually pays off, because:

- Low quality tools need to be replaced earlier than high quality tools;
- Working with worn or partly broken tools means low labour productivity.

### 11.2 PROCUREMENT OF HAND TOOLS

The market is currently flooded with a variety makes of tools. These vary in quality from the reliable and durable to the unreliable and sub-standard tools. When procuring tools it is advisable to maintain a database that will detail the following:

- Date of Purchase
- Name, Address and Contact Details of Manufacturer
- Name, Address and Contact Details of Supplier
- Type of Tool
- Quantity of Tools
- Make and Model Details
- Unit and Total Price
- Warranty and Guarantee Details
- Details and Dates of any Tools returned and exchanged free of charge during Warranty/Guarantee Period.
- Details and Dates of any Tools returned and exchanged with additional charge of charge during Warranty/Guarantee Period.
- Diary of damage or written off tools after Warranty/Guarantee Period.

A normal spreadsheet is adequate for the database. This will assist you in avoiding repeat purchases of sub-standard tools.



### 11.3 WATER AND SANITATION HAND TOOLS

Table 11-1 below gives details of typical activities and hand tools required a typical Water and/or Sanitation Project.

**Table 11-1: Water and Sanitation Hand Tools**

Activity	Tools
Bush clearing	Axe, saw, rope, hook
Grass clearing	Slasher, spade, hoe, fork, rake
Stripping ground cover and grubbing out roots, haul to nearby dump and spread	Pick, hoe, shovel, fork, rake
Grubbing out roots	Pick, hoe, shovel, fork, rake
Destumping (removal of stumps and large roots)	Pick, shovel, axe
Excavation (measured in place) Loose soil Sticky soil Firm soil Hard stony gravel Hard Rock	Shovel Spade, fork, forked hoe Pick, shovel, spade, hoe Pick, shovel, crowbar Firewood, water, sledge hammers, wedges, pick, shovel, crowbar
Loading (measured loose) into: Wheelbarrow, Trailer or Truck	Shovel
Wheel-barrow haul (measured loose; haul and unload only)	Wheelbarrow (Note production increases 30% for good haul route and decreases 30% for poor haul route)
Pipe Bedding	Shovel, spreader, hoe
Spreading loose material (loose m <sup>3</sup> )	Shovel, spreader, hoe
Compaction and re-levelling	Roller, string lines, straightedge, shovel, spreader.
Compaction by pedestrian-controlled double drum vibro-roller	"Stampede" rollers: R75/50 S R90/55 S
Loosen material in trench with pneumatic tools	Compressor, pneumatic tools, team of 4 people
Screen bedding material	Sieve, shovel
Offload flat-bed truck or trailer	Shovel
Trench backfill, hand compaction	Shovel, spreader, hand-tamper, watering can
Collecting loose stone	Gloves, wheelbarrows
Quarrying, prying out cracked rock	Crowbar, gloves, sledgehammer.
Backfill trench and compact	Shovel, watering can, hand-tamper
Pipe Laying (General)	Gloves, Ropes, shear legs
uPVC pipes	Fine-toothed saw or pipe-cutter, Knife, Strap wrench (pair), Marking pen, Measuring tape, Rasp or bevelling tool, Screw driver, Spade extractor, Plastic bags, rubber bands
HDPE pipes	Fine-toothed saw or pipe-cutter, Knife, Strap wrench (pair), Plastic bags, rubber bands, Rasp or bevelling tool, Screw driver, Measuring tape
LDPE pipes	Fine-toothed saw or pipe-cutter, Shifting spanner (small), Measuring tape Knife, Screw driver, Plastic bags, rubber bands

Activity	Tools
Working Surfaces	Workbenches (permanent or portable type)
Holding Devices	Bench vice (used when cutting with hacksaw, dismantling and assembling valves), Pipe vice (used when cutting reaming and threading pipes), Chain vice (support bigger sizes of pipes)
Threading tools	External thread stock and die (used for cutting external threads on pipe conduits and steel bars), Internal thread taps (used for cutting internal threads, extending and re-cutting slightly damaged threads in bottom holes and nuts)
Measuring tools	Tape measure, Folding rule, Steel scale, Try square, Spirit level, Venier callipers
Assembling/disassembling tools	Pipe wrenches (for screwing and unscrewing pipes and pipefitting together), Chain wrench (for bigger pipes), Shifting spanner (used on hexagonal shaped items only), Open end spanner, Ring spanner, Water pump pliers, Screw drivers, Allen keys
Traffic Control Equipment	Portable "Stop", "Go" Signs, Red Flags, Black Yellow Cones
Miscellaneous tools	Hammers, Chisels, Bow lamp, Soldering iron, Steel brushes, Clamps
Miscellaneous Machinery	Threading machine (used for threading, cutting and reaming), Bending machine (for bending pipes), Drilling machine, Bench grinder

Source: CETA

## 11.4 CONVENTIONAL EQUIPMENT

In a labour-based project it may not be feasible to use only labour and light equipment. For example if in a pipeline project the bedding material has to be hauled for long distances, conventional Tipper trucks can be used for that purpose. Table 11-2 is a general guide for conventional equipment that may be used in a typical infrastructure project. See Figure 11-1 below.

Figure 11-1: Hydraulic Excavator (TLB)



Table 11-2: Conventional Equipment

Activity	Conventional Equipment
Excavation	Back Hoe Hydraulic Excavators
Loading	Front End Loaders
Haulage	Tipper Trucks
Spreading	Dumpers, Graders
Compaction	Rollers, Plate Compactors
Other	Water Bowsers, Cranes

### 11.4.1 OWNING AND OPERATIONAL COSTS

The total Equipment cost consists of owning and operating costs as shown in Figure 11-2 below. For Hired equipment you should be able to use the hire rate and the Equipment's productivity to workout the rate of a particular activity. For your own equipment you should be able to workout your owning and operational costs and together with the equipment's productivity you can then build a rate for your activity as listed in the BOQ pr Schedule of activities. The Supplier/Manufacturer of the Equipment and your Accountant can provide assistance in this regard.



Figure 11-2: Equipment Costing Framework

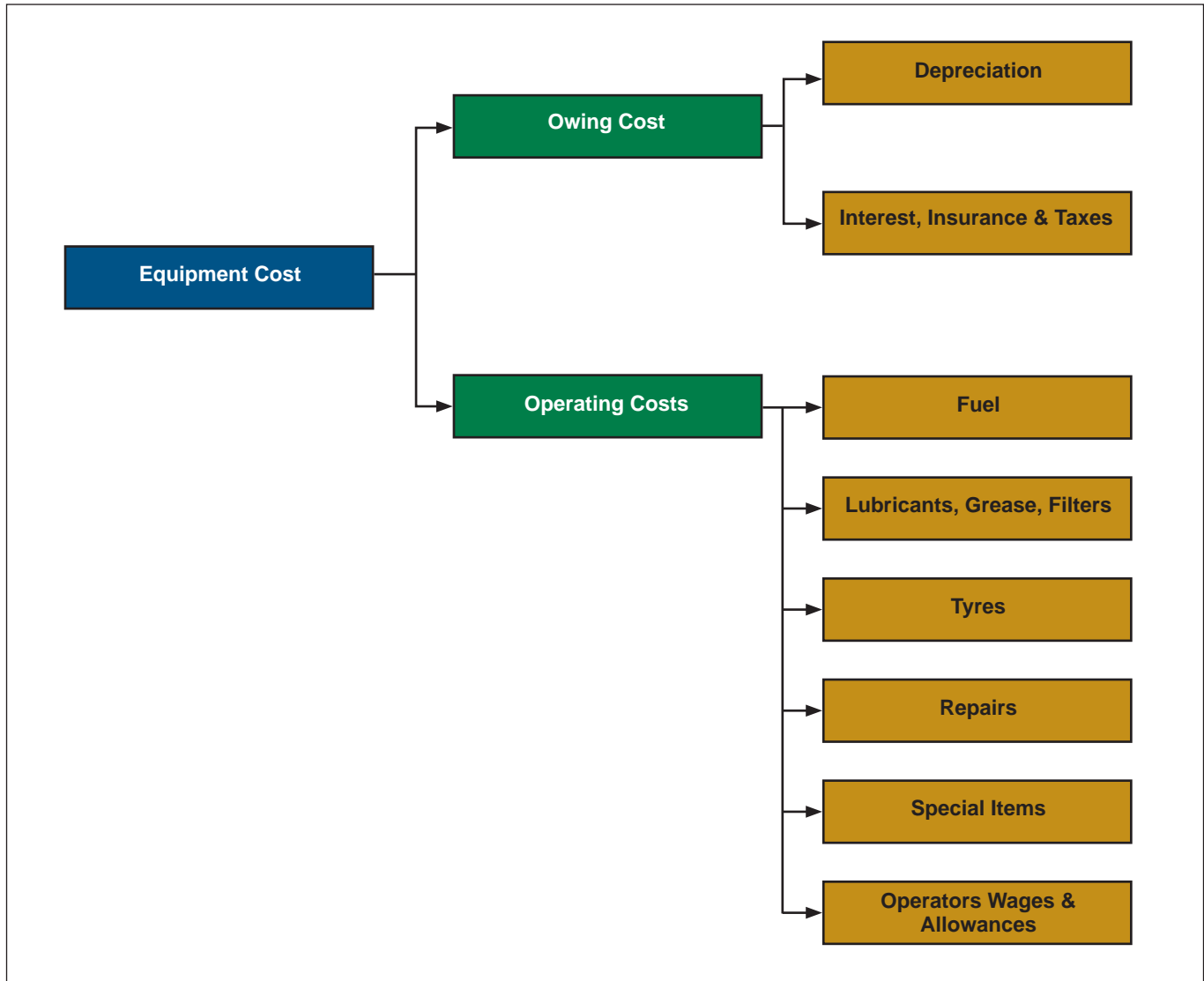

## 12. TENDERING AND PRICING

### 12.1 PRINCIPLES FOR COST ESTIMATING

Estimating costs is a very complex task which requires a lot of experience. It is important that you understand at least the principles of costing.

#### 12.1.1 PURPOSE OF COST ESTIMATION

Estimation involves determining possible cost of work at hand based on the scope of work, current prices of inputs with due consideration of fluctuation of prices over the project period, overheads and profits (if outsourced). Estimating can assist in:

- Building of cost of works. For contractors, it assists them in tendering for work. For Programme Managers and community groups, it assists them to know how much the work will cost.
- Planning: enables timely ordering of the project resources, enables project control and allows you to prepare a cash flow analysis.
- Financing: allows the Programme Managers and contractors to establish the need and evaluate options for financing, e.g. bank loan or overdraft. It allows community groups to prepare cash flow forecasts for financiers.
- Construction: enables Programme Managers and contractors to effectively control project progress and expenditures (cost overruns).

#### 12.1.2 COST COMPONENTS

For normal tenders prepared by contractors, the tender sum for any work item is made up basically three components namely Direct costs, Indirect costs and Profit. The box below gives descriptions of typical direct and in direct costs.

##### Box 12-1: Typical Cost Components

###### Direct Costs

- Labour and tools
- Plant and Equipment
- Material including Transport costs

###### Indirect Costs

- Preliminaries
  - o Site camp facilities
  - o Insurance
  - o Bonds and/or Securities
  - o Road signs
  - o Safety measures
  - o General transport, support or standby equipment
  - o Tendering costs
  - o Accommodation
  - o Salaries, allowances and expenses for supervisory staff
  - o Hire of support equipment





- Selected Major Risks
  - o Bad weather
  - o Work to be redone – especially on work you have not done before
  - o Delayed payment
  - o Carelessness by employees
  - o Price Increases
- Company costs
  - o Company facilities, i.e. offices, stores, workshop (a proportion of the costs to be covered by each contract), security
  - o Interest on loans, etc. (e.g. bank loan to procure equipment or facilities)
  - o Depreciation or replacement of equipment and/or facilities (several possibilities, for example it can be part of the preliminaries or included in the equipment cost when calculating the direct costs. Most important, make sure it is not forgotten).
  - o General expenses (e.g. stationery for administration, electricity bills for office)
  - o Cost for training of staff
  - o Book-keeping, accountants and auditors fees
  - o Protective clothing (if it can be used on many sites)

**Profit**

Based on your assessment of the current situation in the construction market, levels and nature of competition, and scope of work.

**Contingencies**

An amount (or a percentage) is often set aside to cover contingencies. This is an allowance for unforeseen costs resulting from activities not included in the contract. A contingency post helps all parties by offering an opportunity to i) cope with unforeseen problems, and ii) enhance the value of the job by improving specifications or adding minor items.

## 12.2 PRICING

### 12.2.1 LABOUR RATE

The Labour Rate should be Gross Wage which includes the Basic Wage plus Housing, Transport, Site and Miscellaneous allowances where applicable. Miscellaneous may include:

- Unemployment Insurance
- Social Charges including Workmen' Compensation, leave days etc.
- PPE factor
- Risk and Unproductive Time
- Overtime

### 12.2.2 TOOLS RATE

The rate for tools should be calculated per worker per day. It is always economical to procure the required set of tools in bulk for a particular project as the Contractor may benefit from bulk purchase discounts. The total cost can then be spread over the project period depending on the useful life of the tools. The cost of tools needed over a period for a certain number of workers should be computed as shown in the example below.

If a contractor needs R100,000.00 (One Hundred Thousand South African Rand) for tools for a year for 100 workers. The Total worker days for the year for the workers = 100 x 22 x 12 = 26,400 worker days  
 Assuming 22 working days per month.  
 Therefore rates for tools = R100,000/(26,400) = R3.79/wd  
 Note: The total working days should exclude holidays and construction shutdown in December/January.

### 12.2.3 PLANT RATE

Plant hire costs for company owned and /or hired plant should be incorporated into the rates.

### 12.2.4 MATERIAL AND TRANSPORT RATE

Material component should allow for the actual cost of the material including collection, transportation, unloading, storage, wastage, and other handling costs.

Examples to illustrate pricing for various works components are included in the Appendix.

## 12.3 COST BREAKDOWN OF WORKS

Total costs of works are commonly categorized under major bill items for ease of costing and budgeting. An example of a cost breakdown for a single storey house is shown below.

**Table 12-1: Cost Breakdown of Houses**

Item	Description	Percentage
1	Excavations and Concrete Foundations	3%
2	Brickwork up to Plinth	5%
3	Superstructure-Brickwork	25%
4	Roofing	20%
5	Flooring	6%
6	Woodwork, doors, windows	15%
7	Internal Finishes	6%
8	External Finishes	3%
9	Water supply	4%
10	Sanitary work	8%
11	Electrical Works	5%
<b>Total</b>		100%

*See Appendix 3 for pricing for Pipe Construction Works using the LIC Approach.*

Source: Indian Practical Civil Engineer's Handbook

## 12.4 CONTRACT PROCEDURES

The information on Contract Procedures given below is not meant to be exhaustive. It is rather presenting salient issues related to Contracts Management for Employment Intensive Infrastructure works. For more detailed information users are advised to consult relevant publications from the ILO or other organizations.

### 12.4.1 CONTRACTING PARTIES

For most conventional Employment Intensive Infrastructure contracts the different parties have distinct roles and responsibilities:

- The Client, either a Department, Municipality, Statutory authority or private entity, makes an agreement with a Consulting Engineer (consultant), Principal Agent or Project Manager to design a project and to manage the contract.



- The Consulting Engineer/Principal Agent/Project Manager is usually a consultant and is in charge of designing and supervising the project on behalf of the client. On site the Consultants is usually represented by the Resident Engineer or the Engineer’s Representative (Technician).
- A Contractor, who is usually selected through a normal procurement processes, undertakes the construction work. The Contractor is responsible for the proper execution of the work. On site a Site Agent usually represents the Contractor.
- The contractor hires skilled and unskilled Workers for the labour activities. A contract between the contractors and the workers regulates the employment conditions.

Table 12-2: Duties of the Engineer

<p><b>Administrative duties:</b></p> <ul style="list-style-type: none"> <li>• Maintaining daily site records and preparing progress reports on the status of the project;</li> <li>• Ensuring liaison with the local authorities and institutions, particularly on matters such as land disputes, authorisations to carry out surveys, access to quarries, etc.;</li> <li>• Suggesting suspension of the works to the Client in case of serious flaws;</li> <li>• Issuing of the completion certificate and the maintenance certificate for the handing over of the works;</li> <li>• Playing the role of a mediator in the settlement of disputes between the Contractor and the Client;</li> <li>• Ensure that workers are paid according to the schedule and rates agreed;</li> <li>• Arrange site meetings.</li> </ul>
<p><b>Technical duties:</b></p> <ul style="list-style-type: none"> <li>• Ensuring that the Contractor has complied with work standards, Conditions of contract and the schedule of works specified in the contract;</li> <li>• Informing the Client promptly of any defects for which the Contractor is responsible and which could be detrimental to the quality of the project;</li> <li>• Providing technical and managerial advice to the Contractor, as needed;</li> <li>• Ensuring that the Contractor respects the planned time schedule for the works;</li> <li>• Advising the Client on possible modifications in the plans, specifications and work methods;</li> <li>• Ensuring proper execution of remedial works before final handing over of works.</li> </ul>
<p><b>Financial duties:</b></p> <ul style="list-style-type: none"> <li>• Liaise with the clients representative to ensure regular budgetary provision for the work under contract;</li> <li>• Carry out surveys with the Contractor to calculate the quantities of works actually completed;</li> <li>• Certifying monthly statements and submitting interim certificates to the Client for payment;</li> <li>• Liaise with the client representative to ensure the timely payment of certificates.</li> </ul>

Table 12-3: Type of Contractors

TYPE	DESCRIPTION	TYPE OF WORKS
<b>Petty Contractors (Sole Trader)</b>	<ul style="list-style-type: none"> <li>• Single person</li> <li>• Labour only</li> <li>• Limited skills</li> <li>• Not registered</li> </ul>	<ul style="list-style-type: none"> <li>• Infrastructure maintenance,</li> <li>• Labour only sub-contracts,</li> <li>• Repair works</li> </ul>
<b>Small-scale Contractors</b>	<ul style="list-style-type: none"> <li>• Sole Trader</li> <li>• Closed Corporation<sup>22</sup> (owned by 1 to 10 shareholders)</li> <li>• Local builders</li> <li>• Possess some basic Equipment and hand Tools</li> <li>• Registered as tradesmen</li> <li>• Registered with relevant Bodies at lower grades</li> <li>• Capital security low</li> <li>• Possess some technical Skills but limited</li> <li>• Managerial experience</li> </ul>	<ul style="list-style-type: none"> <li>• Building construction,</li> <li>• Sub-contracts for special skills,</li> <li>• Construction and repair of simple structures,</li> <li>• Rural infrastructure rehabilitation</li> </ul>
<b>Medium sized Contractors</b>	<ul style="list-style-type: none"> <li>• Registered</li> <li>• Possess some equipment</li> <li>• Capital security limited</li> <li>• Entrepreneurial skills technical and managerial skills</li> </ul>	<ul style="list-style-type: none"> <li>• Medium Infrastructure works,</li> <li>• Major rehabilitation works,</li> <li>• Pipeline Construction</li> <li>• Pump Stations, Building Works</li> </ul>
<b>Large-scale Contractors</b>	<ul style="list-style-type: none"> <li>• Registered</li> <li>• Good access to equipment</li> <li>• Good capital security</li> <li>• Proven entrepreneurial</li> <li>• Skills</li> <li>• Good technical and managerial skills</li> </ul>	<ul style="list-style-type: none"> <li>• Large infrastructure programmes</li> <li>• Complex building and engineering projects</li> <li>• Works appropriate for</li> <li>• Equipment-intensive work methods</li> </ul>

### 12.4.2 TENDER AND CONTRACT DOCUMENTS

The Tender Documents provide all the legal, Background and technical information to the Tenderers, which will enable them to submit valid and competitive tenders and enter into contract with the client for the provision of the works as specified in the contract. The Contract although normally prepared by the Client should protect both the Client and the Contractor. It should explicitly state the rights and obligations of the Contracting parties. The Client:

- Should clearly specify what he wants to construct.
- The Quality and quantity of the works (in the BOQ and Specifications)
- State whether the works should be predominantly Labour or Machine based
- State who is eligible to Tender
- How the eligible Tenderers may offer their services ( as stated in the Instructions to Tenderers and Forms of Tender”)
- Guarantees that the offers given are serious (“Tender Bonds or Securities”)
- Guarantees of value for money (“Advance Payment Bonds/Security”, Performance Bonds/Security”) and
- The rules and regulations that govern the Project (Conditions of Contract)

Standard Tender/Contract Documentation commonly used in South Africa are presented as reference in Appendix 2.

<sup>22</sup> Applicable to South Africa



## 13. CONSTRUCTION MEASUREMENTS AND CALCULATIONS

### 13.1 THE INTERNATIONAL SYSTEM OF UNITS (SI)

The International System of Units (SI) developed over the years has resulted in so called base units. The SI units are predominantly employed in construction works, thus Programme Managers and Contractors should be able to convert all non-SI units during calculations so as to avoid measurement errors in the Field. The Table below shows Base Units relevant to the Construction Sector.

**Table 13-1: Base Units**

Description	Unit	Symbol
Length	metre	m
Mass	kilogram	kg
Time	second	s
Electric current intensity	Ampere	A
Absolute temperature	Kelvin	K

### 13.2 USEFUL CALCULATIONS AND METRIC CONVERSIONS

#### 13.2.1 LENGTH

The following are common Metric Conversions for length:

**Table 13-2: Common Length Conversions**

Measure	Equivalent to	Measure	Equivalent to
10mm	1cm	100cm	1m
1000m	1km	1000mm	1m
1inch	25.4mm	1foot	304.8mm
1inch	2.54cm	1foot	30.48cm
12inches	1foot	1foot	0.3048m

#### 13.2.2 VELOCITY

The following are common Conversions for velocity:

**Table 13-3: Common Velocity Conversions**

Description	Symbol	One Unit is Equivalent to
Inch per second	in/s	91.44 m/h
Foot per second	ft/s	1.09728 km/h
Yard per second	yd/s	0.9144 m/s
Mile per hour	mile/h	1.609 km/h
Metre per second	m/s	3.289 ft/s
Metre per second	m/s	3.6 km/h
Kilometre per hour	km/h	0.622 mile/h



### 13.2.3 AREA

The following are common conversions for aerial measurements:

**Table 13-4: Calculations for areas of common shapes**

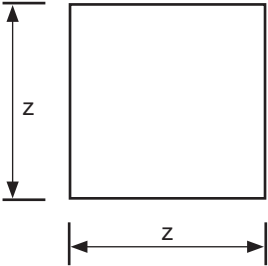
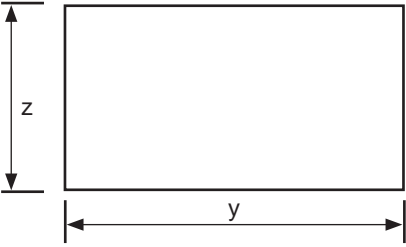
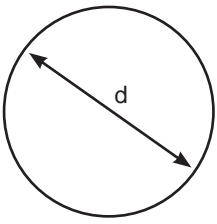
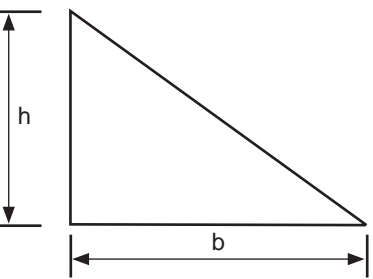
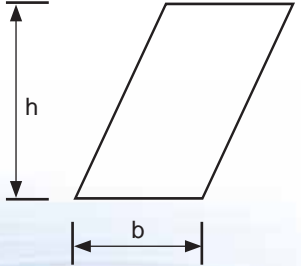
Shape	Description	Area Formula
	Square	$Area = z \times z$
	Rectangle	$Area = y \times z$
	Circle	$Area = \frac{\pi d^2}{4}$
	Triangle	$Area = \frac{b \times h}{2}$
	Rhombus	$Area = b \times h$

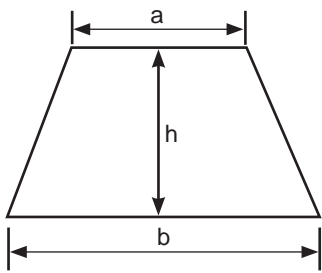
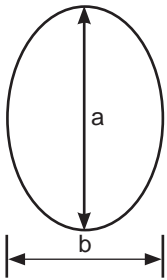
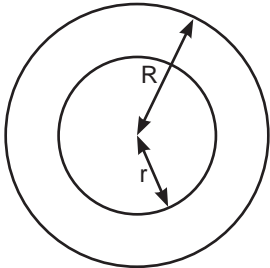
	<p>Trapezium</p>	$Area = \frac{(a + b)}{2} \times h$
	<p>Ellipse</p>	$Area = \pi \times a \times b$
	<p>Annulus</p>	$Area = \pi (R^2 - r^2)$ $= \pi (R - r)(R + r)$

For irregular polygons you can break them into triangles, squares and rectangles in order to calculate the area. Figure 13-1 below shows an irregular shape that could represent an area to be cleared, paved and so on. The total area of the site will thus be:

Total Area = Total Area of Triangles (i.e. A+B+C+D+F) + Total Area of Rectangles (i.e. E+G)  
 = A+B+C+D+F+ E+G

Figure 13-1: Irregular Polygon

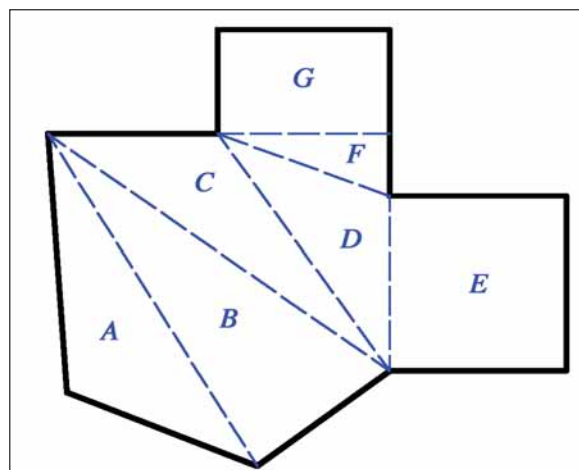





**13.2.4 VOLUME**

The following are common conversions for volume measurements (See Table 13-5) and typical volume calculation formulae (See Table 13-6) encountered in construction:

**Table 13-5: Common Volume Conversions**

Description	Symbol	One Unit is Equivalent to
Cubic inch	in <sup>3</sup>	16.3871 cm <sup>3</sup>
Cubic foot	ft <sup>3</sup>	28.317 l
Imperial gallon	UK gal	4.5461 l
US gallon	US gal	3.7854 l
Cubic Metre	m <sup>3</sup>	1,000,000 cm <sup>3</sup> 1,000 l 220 UK gal 264 US gal
Barrel		

**Table 13-6: Calculations for volume of common shapes**

Shape	Description	Area Formula
	Rectangular Prism	$Volume = h \times l \times b$
	Triangular Prism	$Volume = \left(\frac{h \times l}{2}\right) \times b$
	Quadrilateral Prism	$Volume = \left(\frac{m + l}{2}\right) \times h \times b$

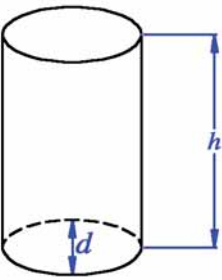
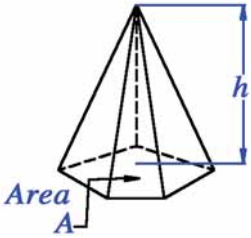
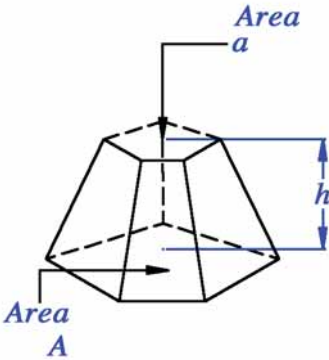
Shape	Description	Area Formula
	Cylinder	$Volume = \left(\frac{\pi \times d^2}{4}\right) \times h$
	Pyramid	$Volume = \frac{A \times h}{3}$
	Truncated Pyramid	$Volume = \frac{h}{3} \left\{ A + a + \sqrt{(A \times a)} \right\}$

*Please note: 1m<sup>3</sup> is the volume of an excavation whose width, length and depth are all equal to 1m.*

### 13.2.5 MASS, WEIGHTS AND DENSITIES

The following are common conversions for mass measurements:

**Table 13-7: Common Mass Conversions**

Description	Symbol	One Unit is Equivalent to
Tonne	t	1,000 kg
Kilogram	kg	1,000 g
Pound	lb	453.592 g

**Definition:** 1 kilogram (kg) is the weight of one litre of water with a temperature of 4°C. Typical densities and weights of construction materials are given in Table 13-8 below:



Table 13-8: Weights of Selected Materials

Material	kg/m <sup>3</sup>	Material	kg/m <sup>3</sup>
Steel and iron	7,800	Stone for masonry work (dense)	2,500-3,000
Aluminium	2,700	Stone for masonry work (porous)	2,200-2,500
Copper	8,900	Building sand (natural moisture)	1,900-2,100
Lead	11,340	Building sand (dry)	1,800-2,000
Wood	400-800	Gravel (clean, without fines)	1,500-1,800
Hardwood	700-1,000	Cohesive soil	1,800-2,000
Asphalt	1,600-2,000	Heavy clay	1,800-2,000
Bitumen	1,100	Cement or lime mortar	1,900-2,100
Cement stone wall (with mortar)	1,800-2,000	Cement (loose)	1,200-1,400
Lime stone wall (with mortar)	1,600-2,000	Lime (loose)	900-1,300
Brick wall (with mortar)	1,300-1,500	Concrete with reinforcement	2,300-2,500
Masonry wall (with mortar)	2,000-2,200	Water	1,000

13.2.6 PRESSURE

Water pressure (P) is defined as distributed force (F) acting on an area (A).

$$P = \frac{\text{Force (F)}}{\text{Area (A)}}$$

Where: F is measured in Newtons (N)  
 A is measured in m<sup>2</sup>  
 P is measured in Pascal (Pa)

The following are common conversions for pressure measurements:

Table 13-9: Common Pressure Conversions

Description	Symbol	One Unit is Equivalent to
Pascal	Pa	1 N/m <sup>2</sup>
Atmosphere	atm	101,330 Pa
A millimetre of Mercury	1 mm Hg	133.32 Pa
A millimetre of Water	1 mm H <sub>2</sub> O	9.8067 Pa
Bar	Bar	10.1998 m of head

### 13.2.7 ELECTRICITY AND ENERGY

The following are important aspects of electrical power:

**Table 13-10: Symbols and Units of Electrical Power**

Description	Symbol	Unit	Unit Symbol
Current	I	ampere	A
Voltage of a direct current or a single-phase alternating current (line-to-neutral voltage)	e	volt	V
Voltage of a three-phase alternating current (line-to-line)	E	watt	W
Active power	P	volt-ampere	VA
Apparent power	EI	ohm	Ω
Resistance	R	ohm	Ω
Reactance	X	ohm	Ω
Impedance	Z		
Power factor (or tan∅)	cos∅		
Efficiency	p	Percent	%
Capacitance	C		
Self-inductance	L		

### 13.2.8 SLOPES

Definition: A slope shows the steepness of an ascent or descent.

**Figure 13-2: Slope Calculation**

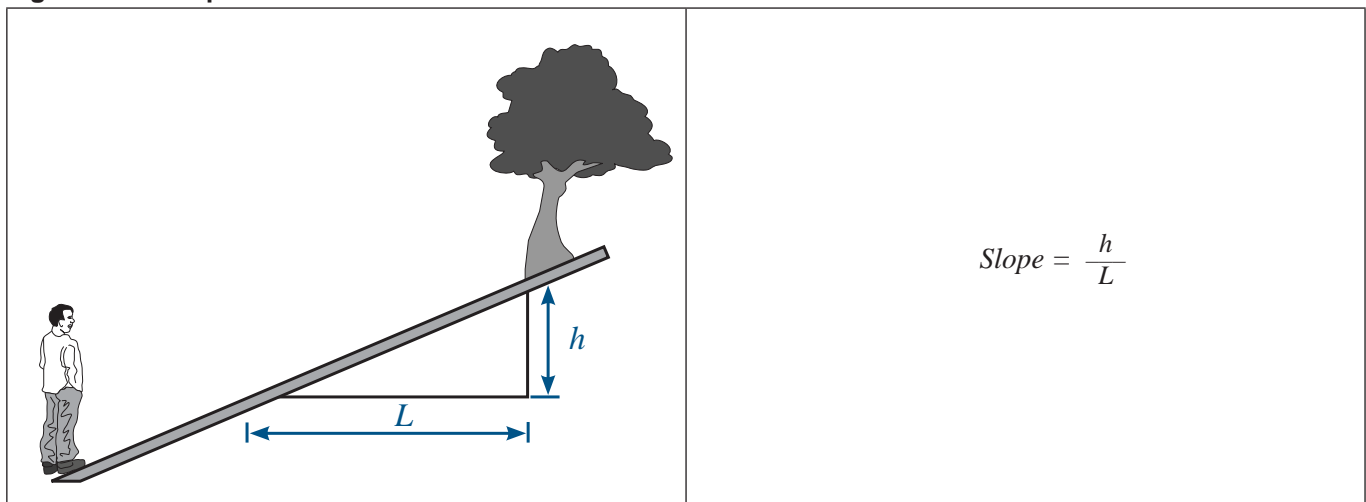

Slope calculation: Slopes can be expressed as a ratio or in percentage.



## 14. REFERENCES

- Ali, M. (2001), *The Sweeping Business*, WEDC
- Bentall, P. et al (1999), *Employment – Intensive Infrastructure Programmes: Capacity Building for Contracting in the Construction Sector*, ISBN 92-2-111 581-X, ILO
- Beusch, A. et al (2002), *Site Supervisor Course for Labour-Based and Community-Managed Upgrading of Urban Low-Income Settlements-Basic Course Manual*, ILO-ASIST
- Beusch, A. et al (2002), *Site Supervisor Course for Labour-Based and Community-Managed Upgrading of Urban Low-Income Settlements-Skills Course Manual*, ILO-ASIST
- Beusch, A. et al (2002), *Site Supervisor Course for Labour-Based and Community-Managed Upgrading of Urban Low-Income Settlements-Supervisor’s Site Reference Handbook*, ILO-ASIST
- Bentall, P., Beusch, B. and de Veen, J. (1999), *Green Guide: Employment - Intensive Infrastructure Programmes: Capacity Building for Contracting in the Construction Sector Guidelines*, ISBN 92-2-111 581-X, ILO
- Bulawayo City Council (1979), *Council Approved Tasks*
- CETA, *Labour Intensive Construction and Maintenance of Water and Sanitation Services: Construction Supervisor Course Module 18*, CETA
- Chudley, R. & Greeno, R. (1999), *Building Construction Handbook*, ISBN 0 7506 3753 0, Butterworth-Heinemann, 3rd Edition,
- CIDB (2006), *Standardized Construction Procurement Documents for Engineering and Construction Works*, CIDB
- CIDB et al (2005), *Labour-based methods and technologies for employment-intensive construction works - A CIDB guide to best practice Part1 to 4*, CIDB
- Clay Bricks: *Technical Guide*
- Cointreau-Levine, S. et al (2000), *Guidance Pack: Private Sector Participation in Municipal Solid Waste Management*, ISBN: 3-908001-90-0, Swiss Centre for Development Cooperation in Technology and Management
- Concrete Manufacturers Association (2003), *Concrete Pipe and Portal Culvert Installation Manual*, ISBN 0-620-13661-8
- Concrete Manufacturers Association (2006), *Concrete Pipe and Portal Culvert Handbook*,
- Concrete Pipeline Systems Association (2006), *Technical Guide No 4- Installation of Manholes*, Concrete Pipeline Systems Association
- CSIR (2000), *Guidelines for Human Settlement Planning and Design*, ISBN 0-7988-5498-7, CSIR
- DEAT (2000), *White Paper on Integrated Pollution and Waste Management for South Africa*, DEAT
- Deverill, P. et al (2002), *Designing Water Supply and Sanitation Projects to meet Demand in Rural and Peri-urban Communities Book 3: Ensuring Participation of the Poor*, WEDC
- Deverill, P. et al (2002), *Designing Water Supply and Sanitation Projects to meet Demand in Rural and Peri-urban Communities Book 1: Concept, Principles and Practice*, WEDC
- Deverill, P. et al (2002), *Designing Water Supply and Sanitation Projects to meet Demand in Rural and Peri-urban Communities Book 2: Additional Notes for Policy Makers and Planners*, WEDC
- DWAF (2001), *Quality of Domestic Water Supplies Volume 3: Analysis Guide*, DWAF



- DWAF (2004), Technical Guidelines for the Development of Water and Sanitation Infrastructure, Second Edition, DWAF
- DWAF(2002), Sanitation Technological Options, DWAF
- DWAF(2005), Sanitation Job Creation: A Guideline for Municipalities, DWAF
- DWAF(2005), Sanitation Job Creation: Stakeholder Position Paper, DWAF
- FAO (2001), Guidelines for the Technical Specifications and Procurement of Agricultural Hand Tools, AGSE/FAO
- Goldie Scot, H. et al (2002), Sustainable community-managed and labour-based upgrading of urban low-income settlements-Handbook, ILO-ASIST
- Goldie Scot, H. et al (2002), Sustainable community-managed and labour-based upgrading of urban low-income settlements-Trainers' Notes, ILO-ASIST
- Goldie Scot, H. et al (2002), Sustainable community-managed and labour-based upgrading of urban low-income settlements-Workbook, ILO-ASIST
- Hammett, M. (1999), Bricks: Notes on their properties, The Brick Development Association Limited (UK)
- Harvey, P. et al (2002), Emergency Sanitation: Assessment and Programme Design, WEDC
- ILO-ASIST, Small-scale Contracting- Module 2 Contracts Management, ASIST-AP
- Intech Beusch & Co.(2004) Contractor's Handbook Labour-based Road Works, NORAD/RDTS
- Johannessen, B. (1997), Technical Manual - Labour Based Construction Methods, ILO
- Khanna, P.N. (1991), Indian Practical Civil Engineers' Handbook, 13th Edition, Engineers' Publishers
- Kong, F.K. et al (1989), Reinforced and Prestressed Concrete, 3rd Edition ELBS 1989
- Mara, D.D. et al (1992), Waste Stabilisation Ponds: A Design Manual for Eastern Africa, ISBN, 0 9519869 0 2; Lagoon Technology International
- NDPW (1993), Specification of Materials and Methods to be used, NDPW Pretoria, 4th Edition
- Obande, M.O. (1996), Block laying and Concreting, ISBN 0 582 06201 2, ELBS, 2nd Edition
- Occupational Safety and Health Administration U.S. Department of Labor (2004), Worker Safety Series: Concrete Manufacturing, U.S. Department of Labor
- Paige-Green, P. (1998), Material Selection and Quality Assurance for Labour-Based Unsealed Road Projects, ILO-ASIST
- Palczynski, R.J. (2002), Study on Solid Waste Management Options for Africa- Project Report, ADB
- Penn, C., Technology Notes, WaterAid
- Petzetakis (2004), PVC Manual, Petzetakis
- Pickford, J. (1995), Low-cost Sanitation: A survey of Practical Experience, ISBN 1 85339 233 2, IT Publications
- Reed, R.A. (1995), Sustainable Sewerage: Guidelines for Community Schemes, ISBN 1 85339 305 3, WEDC
- Sansom, K. et al (Editor) (2003), Contracting out Water and Sanitation Services: Volume 2: Case studies of Service and Management Contracts in Developing Countries, WEDC
- Sansom, K. et al (Editor) (2003), Contracting out Water and Sanitation Services: Volume 1: Guidance Notes for Service and Management Contracts in Developing Countries, WEDC

- Southern African Plastic Pipe Manufacturers Association (2006), Technical Manual, SAPPMA
- Stiedl, D (1998), Productivity Norms for Labour-based Construction, ILO-ASIST
- Tournée, J. et al (2001), Community Contracts in Urban Infrastructure Works Practical Lessons from Experience, ILO-ASIST
- Triche, T. et al (2006), Water Supply & Sanitation Working Notes: Engaging Local Private Operators in Water Supply and Sanitation Services: Initial Lessons from Emerging Experience in Cambodia, Colombia, Paraguay, the Philippines, and Uganda: Volume 1: Overview of Experience, World Bank
- Tyco Water (2004), SINTAKOTE® Steel Pipeline Systems Design Manual, Third Edition, Tyco Water
- van de Haar, J. et al (1995), Design and Training Manual for Piped Rural Water Supplies in Zimbabwe, GTZ
- Viak AB (1989), Rural Water Supply Design Manual: Volume 2: Design Criteria and Technical Requirements, Government of Botswana
- Wallingford, H.R. et al (2003), Handbook for the Assessment of Catchment Water Demand and Use, DFID 2003
- Water Treatment Handbook, Degremont
- WaterAid (1988), Technical Handbook, 2nd Edition, WaterAid
- WEDC (1998), Synthesis Note: The Role of micro-enterprise in solid waste management, WEDC
- WELL/WEDC (1998), Guidance Manual on Water Supply and Sanitation Programmes ISBN 0906055 58 X, WELL/WEDC/LSHTM for DFID
- WHO (2000), Guidelines for Drinking-water Quality First Addendum to Third Edition: Volume 1: Recommendations, ISBN 92 4 154696 4, World Health Organization
- WISA (1988), Manual on the Design of Small Sewage Works, ISBN 0 620 11110 0, 1st Edition

## Web References

- [cnci.org.za/current\\_publications.htm](http://cnci.org.za/current_publications.htm)
- [en.wikipedia.org/wiki/](http://en.wikipedia.org/wiki/)
- [www.cat.com](http://www.cat.com)
- [www.diyfixit.co.uk/diy/building/plastering/plastering\\_2.html](http://www.diyfixit.co.uk/diy/building/plastering/plastering_2.html)
- [www.dur.ac.uk/~des0](http://www.dur.ac.uk/~des0)
- [www4/cal/roads/earthwk/earthwk.html](http://www4/cal/roads/earthwk/earthwk.html)
- [www.dwaf.gov.za/dir\\_ws/content/lids/sanitation.asp](http://www.dwaf.gov.za/dir_ws/content/lids/sanitation.asp)
- [www.environment-agency.gov.uk/subjects/waste](http://www.environment-agency.gov.uk/subjects/waste)
- [www.epa.gov/osw/](http://www.epa.gov/osw/) [www.lifewater.org/resources/tech\\_library.html](http://www.lifewater.org/resources/tech_library.html)
- [www.publicworks.gov.za](http://www.publicworks.gov.za)
- [www.rocla.co.za](http://www.rocla.co.za)
- [www.roymech.co.uk/Useful\\_Tables/Matter/Concrete.html](http://www.roymech.co.uk/Useful_Tables/Matter/Concrete.html)
- [www.usace.army.mil/publications/eng-manuals/](http://www.usace.army.mil/publications/eng-manuals/)
- [m.hse.gov.uk/waste/information.htm](http://m.hse.gov.uk/waste/information.htm)





## 15. APPENDICES

### Appendix 1: Pipe Specifications

Appendix 1 - Table 1: Supratuff PVC-U Pipes (Wall thickness in mm and mass in kg/m)

Size	PN	4	PN	6	PN	9	PN	12	PN	16	PN	20	PN	25
OD	mm	Kg/m	mm	Kg/m	mm	Kg/m	mm	Kg/m	mm	Kg/m	mm	Kg/m	mm	Kg/m
20									1.5	0.15	2	0.17		
25							0.15	0.19	1.9	0.23	2.5	0.27		
32					1.5	0.24	1.9	0.29	2.4	0.36	3.1	0.43		
40			1.5	0.3	1.8	0.36	2.3	0.45	3	0.56	3	0.68		
50	1.5	0.38	1.5	0.38	2.2	0.54	2.9	0.69	3.7	0.86	4.9	1.06		
63	1.5	0.49	1.9	0.6	2.8	0.85	3.6	1.08	4.7	1.37	6.1	1.67		
75	1.5	0.58	2.2	0.83	3.3	1.2	4.3	1.53	5.6	1.94	7.3	2.37		
90	1.8	0.82	2.7	1.2	3.9	1.68	5.1	2.17	6.7	2.77	8.7	3.4		
110	2.2	1.23	2.8	1.33	4.15	1.94	5.45	2.53	7.1	3.27	8.7	3.97	10.6	4.8
125	2.5	1.57	3.25	1.71	4.7	2.51	6.15	3.27	8.05	4.22	9.85	5.13	12.1	6.26
140	2.8	1.95	3.55	2.15	5.2	3.14	6.9	4.1	9	5.3	11	6.43	13.5	7.82
160	3.2	2.56	4.05	2.8	5.95	4.11	7.85	5.35	10.25	6.92	12.55	8.4	15.4	10.19
200	4	3.93	5	4.38	7.45	6.42	9.75	8.36	12.8	10.82	15.7	13.12	19.2	15.89
250	4.9	6	6.25	6.84	9.2	10.03	12.15	13.06	15.95	16.9	19.6	20.5	24	24.87
315	6.9	9.57	7.85	10.86	11.6	15.92	15.3	20.74	20.1	26.83				
355	7	12.09	8.95	13.8	13.7	20.22	17.2	26.34	22.55	34.08				
400	7.9	15.36	9.95	17.52	14.8	25.67	19.45	33.45	25.4	43.26				
450	9.4	19.93	11.2	20.95	16.55	30.51	21.8	39.63						
500	10	23.11	12.45	27.37	18.35	40.11	23.47	52.53						

Manufactured by Petzetakis as follows:

- Supratuff PVC-U Pipes are manufactured as follows:
- To SANS 966 Part 1 specifications.
- Size range 20 – 500mm outside diameter.
- Pressure range – PN 4 - PN 25.
- Plain ended in 20mm – 40mm sizes.
- With integral socket in 50 – 500mm sizes.
- Design stress - 10 MPa in sizes up to 90mm and PN 4 to PN 20.
- Design stress – 10 MPa in sizes 110mm to 500mm in PN 4.
- Design stress – 12.5 MPa in sizes from 110mm to 500mm in PN 6 to PN25.
- Light blue in colour.
- Lengths normally 6 metres



Appendix 1 - Table 2: Ultratuff PVC-A Pipes (Wall thickness in mm and mass in kg/m)

Size	PN	6	PN	9	PN	12	PN	16	PN	20	PN	25
OD	mm	Kg	mm	Kg	mm	Kg	mm	Kg	mm	Kg	mm	Kg
50	1.5	0.35	1.6	0.36	1.7	0.39	2.2	0.5	2.77	0.61	3.38	0.74
63	1.6	0.46	1.6	0.65	2.1	0.85	2.8	1.08	3.49	0.97	4.2	1.16
75	1.7	0.63	1.9	0.92	2.5	1.2	3.2	1.55	4.1	1.37	0.05	2.38
90	1.86	0.76	2.2	0.92	3.1	1.72	3.9	2.2	4.92	1.97	7.38	3.56
110	2.4	0.96	2.76	1.42	3.65	1.8	4.81	2.42	5.95	2.91	8.2	4.38
122	2.46	1.38	3.07	1.72	4.1	2.27	5.3	2.92	6.66	3.61	8.41	4.6
125	2.5	1.24	3.13	1.83	4.14	2.42	5.46	3.12	6.77	3.76	9.33	5.72
140	2.8	1.55	3.51	2.99	4.64	3	6.12	3.92	7.49	4.72	10.66	7.48
160	3.2	2.03	4.01	3.01	5.3	3.92	6.99	5.12	8.71	6.19	11.99	9.15
177	3.58	2.92	4.51	3.65	5.95	4.78	7.89	6.27	9.64	7.57	13.32	11.68
200	3.9	3.18	5.01	4.77	6.63	6.13	8.74	8	10.87	9.65	16.71	18.31
250	5	4.98	6.27	7.31	8.29	9.58	10.93	12.5	13.53	15.03	17.2	18.3
315	6.2	7.86	7.9	11.6	10.44	15.21	13.77	19.84	17.5	23.81		
355	7.2	9.99	8.9	14.73	11.77	19.32	15.52	25.2	19.7	30.23		
400	7.8	12.68	10.13	18.71	13.26	24.53	17.49	31.99	22.3	38.43		
450	9.4	20.76	11.6	21.49	15.4	28.57	24.95	39.97	24.95	51		
500	9.8	19.81	12.53	29.23	16.57	38.33						

Manufactured by Petzetakis as follows:

- To SANS 966 Part II specifications.
- Size range 50 – 500mm outside diameter.
- Pressure range PN 6 - PN 25.
- With integral sockets.
- Design stress 18.5Mpa.
- Dark blue in colour.
- Lengths normally 6 metres.

Appendix 1 - Table 3: Supramyn Pipes (Wall thickness in mm and mass in kg/m)

Size	PN7 air		PN6 water		PN9 water		PN12 water		PN16 water		PN20 water	
OD	mm	Kg/m	mm	Kg/m	mm	Kg/m	mm	Kg/m	mm	Kg/m		
<b>10MPa DESIGN STRESS PIPE</b>												
55	3.28	0.8	1.5	0.41	2.46	0.61	3.28	0.81	4.2	1		
90	5.1	2.2	1.8	1.2	3.9	1.68	5.1	2.2	6.7	2.77		
<b>12.5MPa DESIGN STRESS PIPE</b>												
105	6.4	2.8	2.7	1.33	3.9	1.8	5.1	2.31	6.8	3.03	8.3	3.7
110	6.75	3.7	2.8	1.89	4.2	1.99	5.4	2.5	6.89	3.33	8.7	4
155	9.35	6.1	3.8	2.86	5.8	4.01	7.6	5	9.92	6.4	12.5	7.9
160	9.7	6.78	4	3	6	4.16	7.3	5.3	9.5	6.7	11.85	6.7
200	12.1	10.62	5	4.69	7.4	6.49	9.2	8.2	11.9	10.6	15.7	10.05
210	12.6	11.3	5.3	4.96	7.7	6.77	10.3	9.27	10.3	9.27	16.5	15.5
250	15.05	15.6	6.3	7.39	9.2	10.01	11.45	13.06	15.04	16.9	18.52	20.5
315	19	26.13	6	7.8	11.53	11.6	16.08	14.43	20.74	18.95	26.83	

Appendix Table 4: Maincore PVC-U Sewer Pipes (Wall thickness in mm and mass in kg/m)

Size	100	KPa	200	KPa	400	KPa
	Pipe thickness	Mass per metre	Pipe thickness	Mass per metre	Pipe thickness	Mass per metre
OD	mm	Kg/m	mm	Kg/m	mm	Kg/m
110	2	0.75	2.75	0.91	3.2	1.22
160			4.2	2.27	4.8	2.41
200			5	3.38	6	3.76
250			6.3	5.56	7.3	5.96

Maincore multi-layer sewer pipes are manufactured by Petzetakis as follows:

- To SANS 1601.
- With foamed core in a multi-layer configuration.
- In sizes 110 – 250mm.
- With pipe stiffness of 100 KPa, 200 KPa and 400 KPa.
- With plain ends in 110mm.
- With integral sockets – 110-250mm.
- Beige in colour.



**Appendix 1 - Table 5: Supradur Sewer**

Size	Class 51-100kPa		Class 34-300kPa	
	mm	kg/m	mm	kg/m
110	2.2	1.23	3.2	1.74
160	3.2	2.56	4.7	3.65
200	3.9	3.93	5.9	5.7
250	4.9	6	7.3	8.82
315	6.2	9.57	9.2	13.96
355	7	12	10.6	17.74
400	7.8	15.36	11.7	22.44
500	10	23.11	15.45	34.09

Supradur sewer pipes are manufactured by Petzetakis as follows:

- To SANS 791 specifications
- Size range 110 – 500mm.
- Pipe stiffness 100kPa (Class 51)
- Pipe stiffness 300kPa (Class 34)
- Plain ended 110mm
- With integral sockets 110 – 500mm
- Beige in colour

**Appendix 1 - Table 6: Supradrain PVC-U Cable Pipes**

Size OD	Pipe Thickness mm	Unit Mass kg/m
50	1.5	0.38
63	1.5	0.49
75	1.8	0.82
90	1.8	0.82
110	2.2	1.23
125	2.5	1.57
140	2.8	1.95
160	3.2	2.56
200	4.0	3.93
250	4.9	6.0
315	6.9	9.57

Supradrain PVC-U cable pipes are manufactured by Petzetakis as follows:

- To SANS 966 part 1 dimensions for PN 4 pipe.
- Using 100 percent regrind material.
- Coloured black for easy identification.

Appendix 1 - Table 7: Slotted PVC-U subsoil drainage pipes

Pipe Size	Average Length slots (mm)	Width of slots (mm)	Distance between Slots(mm)	Number of rows
50	26	2.1	67.4	3
63	31	2.1	67.4	3
75	35	2.1	67.4	3
90	42	2.1	67.4	3
110	56	2.1	67.4	3
160	74	2.1	67.4	3
200	84	2.1	67.4	3

Slotted PVC-U subsoil drainage pipes are manufactured by Petzetakis as follows:

- Using 100 % reground material.
- To SANS 966 part 1 dimensions for PN 4 pipe.
- Complete with integral sockets
- Black in colour
- In 6 metre lengths
- Size range 50 to 200mm O.D.

Appendix 1 - Table 8: Maincase PVC-U Borehole Casings

Size OD (mm)	Size ID (mm)	Wall thickness (mm)	Unit Mass (kg/m)
110	100	5.04	2.57
110	97	6.62	3.32
114	103	5.6	2.87
125	114	5.73	3.32
125	110	7.52	4.29
140	127	6.41	4.17
140	123	8.42	5.37
160	145	7.33	5.43
160	141	9.62	7.01
168	151	8.5	6.52
186	168	8.75	7.25
200	181	9.16	8.44
200	176	12.03	10.93
228	210	9.2	9.48
250	227	11.46	13.19
250	220	15.04	17.05
315	293	10.95	16.08
315	286	14.43	20.95

Maincase PVC-U borehole casings are fabricated by Petzetakis using Supratuff pressure pipes as follows:-

- To SANS 966 part I specifications
- Size range 110mm to 315mm
- Threaded both ends to ASTM F 480 2 TPI and DIN 4925 specifications
- Slotted in sizes 0.5mm to 3mm
- Light blue in colour
- Lengths normally of 2.9m and 5.8 metres.



**Appendix 1 - Table 9: Long Hallmore's SINTAKOTE® Steel pipeline Systems**

Section Dimensions				Pipe Bore		Mass/metre				Mass/Pipe			
Steel Shell		CML	SK	Steel	CML	Steel	CML	SK	Total	Pipe Length			
OD	t	T	ts			M1	M2	M3	MTOT	6m	9m	12.2m	13.5m
mm	mm	mm	mm	mm	mm	kg/m	kg/m	kg/m	kg/m	Tonne	Tonne	Tonne	Tonne
114	4.8	9	1.6	104	86	12.9	6.5	0.5	19.9	0.12			
168	4.5	9	1.6	159	141	18.1	10.2	0.8	29.1	0.17	0.26		
168	5	9	1.6	158	140	20.1	10.1	0.8	31	0.19	0.28		
190	4.5	9	1.6	181	163	20.6	11.7	0.9	33.2	0.2	0.3		
190	5	9	1.6	180	162	22.8	11.6	0.9	35.3	0.21	0.32		
219	5	9	1.6	209	191	26.4	13.6	1	41	0.25	0.37		
240	5	9	1.6	230	212	29	15	1.1	45.1	0.27	0.41		
257	5	9	1.6	247	229	31.1	16.2	1.2	48.5	0.29	0.44		
273	5	9	1.6	263	245	33	17.3	1.3	51.6	0.31	0.46		
290	5	12	1.8	280	256	35.1	24.3	1.5	61	0.37	0.55		
305	5	12	1.8	295	271	37	25.6	1.6	64.3	0.39	0.58		
324	5	12	1.8	314	290	39.3	27.4	1.7	68.4	0.41	0.62		
324	6	12	1.8	312	288	47.1	27.2	1.7	76	0.46	0.68		
337	5	12	1.8	327	303	40.9	28.5	1.8	71.3	0.43	0.64		
337	6	12	1.8	325	301	49	28.4	1.8	79.1	0.47	0.71		
356	5	12	1.8	346	322	43.3	30.3	1.9	75.4	0.45	0.68		
356	6	12	1.8	344	320	51.8	30.1	1.9	83.8	0.5	0.75		
406	5	12	1.8	396	372	49.4	34.8	2.2	86.4	0.52	0.78	1.05	
406	6	12	1.8	394	370	59.2	34.6	2.2	96	0.58	0.86	1.17	
419	5	12	1.8	409	385	51	36	2.2	89.2	0.54	0.8	1.09	
419	6	12	1.8	407	383	61.1	35.8	2.2	99.1	0.59	0.89	1.21	
457	5	12	1.8	447	423	55.7	39.4	2.4	97.6	0.59	0.88	1.19	
457	6	12	1.8	445	421	66.7	39.2	2.4	108.4	0.65	0.98	1.32	
457	8	12	1.8	441	417	88.6	38.9	2.4	129.9	0.78	1.17	1.58	
457	10	12	1.8	437	413	110.2	38.5	2.4	151.2	0.91	1.36	1.84	
502	5	12	1.8	492	468	61.3	43.5	2.7	107.4	0.64	0.97	1.31	1.45
502	6	12	1.8	490	466	73.4	43.3	2.7	119.4	0.72	1.07	1.46	1.61
502	8	12	1.8	486	462	97.5	42.9	2.7	143.1	0.86	1.29	1.75	1.93
508	5	12	1.8	498	474	62	44	2.7	108.8	0.65	0.98	1.33	1.47
508	6	12	1.8	496	472	74.3	43.9	2.7	120.8	0.72	1.09	1.47	1.63
508	8	12	1.8	492	468	98.6	43.5	2.7	144.8	0.87	1.3	1.77	1.96
508	10	12	1.8	488	464	122.8	43.1	2.7	168.6	1.01	1.52	2.06	2.28
559	5	12	2	549	525	68.3	48.7	3.3	120.3	0.72	1.08	1.47	1.62
559	6	12	2	547	523	81.8	48.5	3.3	133.6	0.8	1.2	1.63	1.8
559	8	12	2	543	519	108.7	48.1	3.3	160.1	0.96	1.44	1.95	2.16
559	10	12	2	539	515	135.4	47.7	3.3	186.4	1.12	1.68	2.27	2.52
610	5	12	2	600	576	74.6	53.3	3.6	131.5	0.79	1.18	1.6	1.77
610	6	12	2	598	574	89.4	53.1	3.6	146.1	0.88	1.31	1.78	1.97
610	8	12	2	594	570	118.8	52.7	3.6	175.1	1.05	1.58	2.14	2.36

**Note:**

SK: SINTAKOTE lining. SINTAKOTE is a registered trademark. A black polyethylene coating is fusion bonded directly to the steel pipe, hence the coating is also known as Fusion Bonded Polyethylene (FBPE).

CML: Cement mortar lining.

Calculations based on:

**Masses:**

Steel shell:  $M1 = 0.02466(D-t)t$  kg/m

Cement lining:  $M2 = 0.00755T(D-2t-T)$  kg/m

SINTAKOTE:  $M3 = 0.00295Dts$  kg/m

Pipe Mass  $MTOT = M1 + M2 + M3$  kg/m

where

D = outside diameter of pipe mm

t = steel wall thickness mm

T = cement mortar lining thickness mm

ts = SINTAKOTE® thickness mm

Total mass may carry minor round-off error.

## Appendix 2: South African Standard Contract Documents and Specifications

The widely used Tender/Contract Document currently in South Africa is that produced by Construction Industry Development Board (CIDB). The CIDB’s Standardized Construction Procurement Documents for Engineering and Construction Works recommends two formats namely a three volume one and a single volume one whose contents are shown below:

**Appendix 2 - Table 1: CIDB Three Volume Tender Document Format**

Volume	Contents Number	Heading
<b>Volume 1</b>	Part T1: Tendering procedures	
	T1.1	Tender Notice and Invitation to Tender
	T1.2	Tender Data
<b>Volume 2</b>	Part T2: Returnable documents	
	T2.1	List of Returnable Documents
	C1.1	Form of Offer and Acceptance
	C1.2	Contract Data (Part 2: Data Provided By The Contractor)
	C2.2	Activity Schedule or Bill of Quantities
	T2.2	Returnable Schedules
<b>Volume 3</b>	Part C1: Agreement and Contract Data	
	C1.2	Contract Data (Part 1: Data provided by the employer)
	Part C2: Pricing data	
	C2.1	Pricing Instructions
	Part C3: Scope of Work	
	C3	Scope of Work
	Part C4: Site Information	
	C4	Site Information

**Appendix 2 - Table 2: CIDB Single Volume Tender Format**

Contents Number	Heading
<b>The Tender</b>	
Part T1: Tendering procedures	
T1.1	Tender Notice and Invitation to Tender
T1.2	Tender Data
Part T2: Returnable documents	
T2.1	List of Returnable Documents
T2.2	Returnable Schedules
<b>The Contract</b>	
Part C1: Agreement and Contract Data	
C1.1	Form of Offer and Acceptance
C1.2	Contract Data
Part C2: Pricing data	
C2.1	Pricing Instructions
C2.2	Activity Schedule or Bills of Quantities
Part C3: Scope of Work	
C3	Scope of Work
Part C4: Site information	
C4	Site Information





## Tender Procedures

Generally these should be guided by SANS 294: Construction procurement processes, methods and systems.

## General Conditions of Contract

The following General Conditions of Contract are available for use in South Africa:

- (i) General Conditions of Contract for Construction Works as published by the South African Institution of Civil Engineering.
- (ii) Conditions of Contract for Construction for Building and Engineering Works designed by the Employer ("Red Book") (1999) as published by the International Federation of Consulting Engineers (FIDIC).
- (iii) Conditions of Contract for Plant and Design-Build for Electrical and Mechanical Plant and for Building and Engineering Works, designed by the Contractor ("Yellow Book") (1999) as published by FIDIC.
- (iv) Conditions of Contract for EPC Turnkey Projects ("Silver Book") (1999) as published by FIDIC.
- (v) Short Form of Contract ("Green Book") (1999) as published by FIDIC.
- (vi) JBCC series 2000 Principal Building Agreement as published by the Joint Building Contracts Committee.
- (vii) JBCC series 2000 Minor Works Agreement as published by the Joint Building Contracts Committee.
- (viii) NEC3 Engineering and Construction Short Contract (ECSC) as published by the Institution of Civil Engineers.
- (ix) NEC3 Engineering and Construction Contract (ECC) as published by the Institution of Civil Engineers.

## Civil Engineering Specifications

SANS 1200 (formerly SABS 1200) should be incorporated into the Tender/Contract documents' Scope of Works. The list of SANS1200 Specifications is attached herewith in the Appendix. SABS intends to supersede the SANS 1200 suite with SANS 2001 suite.

### **SANS 1200 Standardised Specification for Civil Engineering Construction List (Formerly SABS 1200)**

SANS A	General
SANS AA	General (Small Works)
SANS AB	Engineers Office
SANS AD	General (Small Dams)
SANS AAH	General (Structural)
SANS C	Site Clearance
SANS D	Earthworks
SANS DA	Earthworks (Small Works)
SANS DB	Earthworks (Pipe Trenches)
SANS DE	Small Earth Dams
SANS DK	Gabions and Pitching
SANS DM	Earthworks (Roads Subgrade)
SANS DN	Earthworks (Railway Sidings)
SANS F	Piling
SANS G	Concrete (Structural)
SANS GA	Concrete (Small Works)
SANS GB	Concrete (Ordinary Buildings)
SANS GE	Precast Concrete (Structural)
SANS GF	Prestressed Concrete
SANS H	Structural Steelwork
SANS HA	Structural Steelwork (Sundry Items)
SANS HB	Cladding and Sheetwork
SANS HC	Corrosion Protection of Structural Steelwork
SANS HE	Structural Aluminium work
SANS L	Medium-Pressure Pipelines
SANS LB	Bedding (Pipes)
SANS LC	Cable Ducts
SANS LD	Sewers
SANS LE	Stormwater Drainage
SANS LF	Erf Connections (Water)
SANS LG	Pipe Jacking
SANS M	Roads (General)
SANS ME	Subbase
SANS MF	Base
SANS MFL	Base ( Light Pavement Structures)
SANS MG	Bituminous Surface Treatment
SANS MH	Asphalt Base and Surfacing
SANS MJ	Segmented Paving
SANS MK	Kerbing and Channeling
SANS MM	Ancillary Roadworks
SANS NB	Railway Sidings (Trackwork)



## Appendix 3: Pipeworks Pricing Example

Appendix 3 - Table 1: BOQ Extract

ITEM	LIC	DESCRIPTION	UNIT	QTY	RATE	AMOUNT
1.0		Site Clearance (DB 8.3.1)				
		(a) Clear vegetation and trees of girth up to 1m along the Lines of Sewer pipes of the following Diameters				
	LI	(i) 110mm	m	95,000		
	LI	(ii) 160mm	m	118,200		
	LI	(d) Remove topsoil to a depth not exceeding 150mm	m <sup>2</sup>	280,000		
2.0		Excavation (DB 8.3.2)				
2.01		Excavate in all materials for pipe trenches, backfill, compact and dispose of surplus excavated material along the trench servitude for pipes of diameters (a) Depth not exceeding 1.5m				
	LI	(i) 110mm	m	56,050		
	LI	(ii) 160mm	m	82,411		
2.02		Extra over excavations				
		(b) For disposal of excess excavated material to an approved spoil dump.				
	LI*	(i) Within 0.5km Freehaul distance. Allow for hand loading and haulage by wheel barrow for a maximum distance of 150m and hand spreading	m <sup>3</sup>	111,400		
	LI*	(ii) In excess of 0.5km Freehaul distance (Maximum distance 5km by Tipper Trucks, Loading by hand)	m <sup>3</sup> .km	12,290		
2.05		Opening up and closing down designated borrow pits (DB 8.3.3.2)	Sum			
5.0		Supply of Bedding Material (LB 8.2)				
5.01		Provision of bedding from Trench excavations (0.5km freehaul distance) (LB 8.2.1)				
	LI**	(a) Selected granular material (Each worker will select 1.8 m <sup>3</sup> per day)	m <sup>3</sup>	15,000		
6.0		Construction of Gravity Pipes (LD8.2)				
6.01		Supply, lay, joint, bed and test the following gravity sewer pipelines. (a) Class 34 uPVC (Solid Wall) pipes of nominal diameters indicated below, with Z-lok end socket laid in selected granular material				
	LI	(i) 110mm	m	95,000		
	LI	(ii) 160mm	m	118,170		
<b>TOTAL CARRIED TO MAIN SUMMARY</b>						

\*LI blended with Equipment

Selected Items are priced as below. Attempt the rest for yourself.



**DAILY LABOUR RATE:**

<b>1. Wages and Transport Allowance</b>			
Minimum Wage	= R 50.00	per day	At a minimum rate to be as per DOL/EPWP regulations and agreed with Implementing body.
Transport ( as a percentage of daily Wage) say 20%	= 20% * R50 = R10.00	per day	This should at least cover actual transport cost
Total Wage rate including transport allowance	= R(50+10)	per day	
	<b>= R60.00</b>	per day	

<b>2. Site Allowance</b>			
Total Mark-Up On Basic Wage	= 0.0%	Allow for markup as necessary.	
Site Support	= 20.0%	Allow for support as necessary.	
Handtools	= 10%	Allow for handtools as necessary. As an example, if you need say R100,000 for tools in year and your effective working days are 200/ year excluding holidays and Construction Shutdown. For your 100 workers the total worker days = 200*100= 20000, Therefore tool per worker day = 100000/20000 = R5/wd	
Total Site Allowance	= 30%		
Therefore Direct Daily Labour Rate	= R(15+60)		
	<b>= R75.00</b>	of basic wage.	

<b>3. Contractor Allowances</b>			
Overhead	= 10%	Allow for Overhead as necessary.	
Profit	= 10%	Allow for profit as necessary. Remember if your Profit markup is too high you may lose the bid and if its too low you may run at a loss if your other markups do not cover your actual cost.	
Total Contractor Allowance	= 20%		
	= 20%*R75	Of Direct Daily labour rate	
	<b>= R15.00</b>		

Therefore "All-in" Total Daily Labour Rate	= R(15+75)
	<b>= R90.00</b>

**Item 1(i) Site Clearance**

**Labour Rate R 90.00 per day**

<b>Labour and Tools</b>			
Productivity Rate for Site Clearance Assuming Medium Bush	200	m <sup>2</sup> /wd	
No. of Workdays to clear 1m assuming you need to clear a 4m width		4 × 1 = 4 m <sup>2</sup> per m	
Therefore Worker days		4 ÷ 200	= 0.02 wd
Rate for clearing		0.02 × R 90.00	= R 1.80 per m
<b>Total for Labour and Tools</b>			<b>= R 1.80 per m</b>
<b>Plant and Equipment</b>	No Plant needed		
<b>Total for Plant</b>			R 0.00 per m
Material			=R 0.00 per m
<b>Total for Material</b>			<b>R 0.00 per m</b>
<b>Transport</b>	For large schemes you may need to transport material to a dump site.		
<b>Total Transport</b>			R 0.00 per m
<b>Sub Total Rate</b>			R 1.80 per m
<b>Allow for 15% Profit</b>			R 0.27 per m
<b>Total Rate</b>			<b>R 2.07 per m</b>

**Item 2.01(i) Excavation**

Labour Rate R 90.00 per day

<b>Labour and Tools</b>			
Productivity Rate for Soft Excavation	5 m <sup>3</sup> /wd		
Productivity Rate for Backfilling	13 m <sup>3</sup> /wd		
Productivity Rate for Hand Compaction	9 m <sup>3</sup> /wd		
Volume to be excavated if trench width is 0.71m		1.5 × 0.71	= 1.065m <sup>3</sup> per m
Volume to be backfilled assume 1.2 bulking and additional 20% for backfilling up to 300mm above ground	1.065 × 1.2 × 1.2	= 1.5336 m <sup>3</sup> per m	
Volume to be compacted			= 1.5336m <sup>3</sup> per m
<b>No. of Worker days per metre</b>			
Excavation		1.065 ÷ 5	= 0.213 wd
Backfilling		1.5336 ÷ 13	= 0.117969 wd
Compaction		1.5336 ÷ 9	= 0.1704 wd
Therefore Total Worker days			= 0.501369 wd
Rate for Item	0.501369 × R 90.00	= R 45.12 per m	
<b>Total for Labour and Tools</b>			= R 45.12 per m
<b>Plant and Equipment</b>	No Plant needed		
<b>Total for Plant</b>			R 0.00 per m
Material			R 0.00 per m
Total for Material			R 0.00 per m
<b>Transport</b> For large schemes you may need to transport material to a dump site.			
<b>Total Transport</b>			R 0.00 per m
<b>Sub Total Rate</b>			R 45.12 per m
Allow for 15% Profit			R 6.77 per m
<b>Total Rate</b>			R 51.89 per m



Item 6.01 (ii) Pipe Laying

Labour Rate R 90.00 per day

<b>Labour and Tools</b>			
Productivity Rate for laying a 160mm dia pipe	2.7 m/wd		
No. of Workdays to lay and bed 1m		$1 \div 2.7$	= 0.37037 wd
Rate for laying 1m		$0.37037 \times R\ 90.00$	= R 33.33
<b>Total for Labour Tools</b>			= R 33.33 per m
<b>Plant and Equipment</b>	No Plant needed		
<b>Total for Plant</b>			= R 0.00 per m
<b>Material</b>			
Pipe Cost @ R330 per m plus 30% transport		$1 \times R\ 429.00$	= R 429.00 per m
NB. Supply of Bedding Material is priced Elsewhere in the BOQ			
<b>Total for Material</b>			R 429.00 per m
Transport Included in Material Price NB: Obtain Quotations from Transport Companies			
<b>Total Transport</b>			R 0.00 per m
<b>Sub Total Rate</b>			R 462.33 per m
Allow for 15% Profit			R 69.35 per m
<b>Total Rate</b>			R 531.68 per m

## Appendix 4: Successful Plastering <sup>23</sup>

### Table of Contents

1. Introduction
2. Requirements
3. Selecting materials
4. Mix proportions
5. Surface preparation
6. Application
7. Specifications
8. Conclusion

### 1. Introduction

Sand-cement plaster is used extensively in building work as a decorative or protective coating to concrete and masonry walls and concrete ceilings.

The aim of this publication is to provide the technical information needed for successful plastering. It is intended for architects, building contractors, building inspectors, and anyone in need of guidance to achieve a satisfactory standard of work.

Aspects dealt with include selection of materials, mix proportions, surface preparation and correct plaster application. This publication deals with conventional architectural applications of plaster. Special applications such as squash courts and swimming pools are outside its scope.

### 2. Requirements

Plaster has important requirements in the fresh and hardened states.

In the fresh state, plaster must be workable and cohesive, i.e. it must be plastic, and have good water retention. The properties of fresh plaster depend on the materials used, especially the sand, and on mix proportions.

In the hardened state, plaster must be: strong enough to hold paint and withstand local impact and abrasion; free of unsightly cracking; well bonded to the substrate; have an acceptable surface texture; and have acceptable surface accuracy (with reference to a plane or curved surface). The properties of hardened plaster depend on the properties of the fresh plaster and the substrate, and on workmanship.

The following sections give information that should make it possible to meet these requirements.

### 3. Selecting materials

As discussed in section 2, the properties of plaster in both fresh and hardened states depend to a large extent on the properties of the materials used. This section gives guidance on selecting materials.

#### 3.1 Cement

Use “common” cement complying with SANS 50197-1, or masonry cement complying with SANS 50413-1 strength class 22,5X or higher. Always ensure that the cement used bears an SABS mark. Note that it is illegal to sell cement which does not bear this mark.

The choice of cement should be based on the properties of the sand (see sections 3.2 and 3.3).

---

<sup>23</sup> As published by Cement & Concrete Institute (South Africa), 2006



### 3.2 Sand

Sand is by far the major constituent of a plaster mix and has a significant influence on its performance and material cost.

In South Africa, natural sands, i.e. pit, river and dune sands, are almost invariably used for plaster mixes.

An essential requirement is that sand should be free of organic matter such as roots, twigs and humus.

**Note:** “Karoo” sands, which consist mainly of disc shaped dark-coloured particles, should not be used for plastering.

This is because they exhibit excessive swelling and shrinkage with increasing and decreasing moisture content. Crusher sands are also not generally suitable due to their angular particle shape. However, crusher sands are used successfully in rich mixes for special applications such as squash court plastering.

**Important properties of sands are:**

- Clay content
- Grading
- Maximum particle size
- Particle shape

SANS 1090:2002 the standard covering sand for plaster and mortar gives limits for certain properties of sands but these should be regarded as no more than a guide. It has been found that sands meeting this standard do not necessarily produce satisfactory plaster; conversely sands that do not meet this standard may produce acceptable mixes.

**Grading**

Ideally, the sand should have a continuous grading, from dust to the largest particles. The fractions passing the 0,15

mm and 0,075 mm sieves (“fines”) are important because they significantly influence the water requirement, work ability and water retentivity of the mix. Increasing these fractions results in increased water requirement (with consequent lower strength and higher shrinkage), but improved workability and water retentivity. The optimum fines content is therefore a compromise between these properties.

A sand lacking in fines may be used with hydrated builder’s lime, mortar plasticizer, or masonry cement (see section 3.3).

Sand with excessive fines may be improved by washing or by blending with suitable coarser sand.

Recommended gradings are shown in Table 1.

**Appendix 4 - Table 1: Recommended grading for plaster sand**

Sieve size mm	Percentage passing sieve by mass
2.36	100
1.18	100–70
0.60	100–45
0.30	65–25
0.15	40–10
0.075	15–5

Note: Some coarser material may be acceptable, or desirable, for textured decorative work.

- Such sieves are expensive and normally found only in laboratories. For a field test, place a few handfuls of dry sand in the foot of a nylon stocking and tie closed. Shake the sand and collect the dust in a bowl.

### Maximum particle size

For conventional smooth plaster, all the sand should pass through a sieve with 2,36 mm square openings. For coarsely textured decorative work the corresponding sieve size is 4,75 mm.

Oversize particles (and lumps) should be removed by sieving.

### Clay content

Only a small proportion of clay can be tolerated in plasters and.

Sands with high clay content may generally be recognised as follows:

- The fraction that passes a 0,075 mm sieve can, after being moistened, be rolled into a thread about 3 mm or less in diameter.
- Plaster mixes made with such sands are:
  - Very “fatty” and tend to cling to a trowel
  - Have a high water requirement

*(See Assessing the suitability of sand for plastering below.)*

Specialist advice should be sought if there is any doubt about the content and type of clay in a sand.

### Assessing the suitability of a sand for plastering

A sand may be assessed by doing both of the following:

- Comparing grading and maximum particle size, and –if necessary – apparent clay content, with their commendations given.
- Making a mix to assess water requirement and workability.

### Mix assessment is done as follows:

(i) Weigh out the following amounts of material:

- 5 kg of cement
- 25 kg of dry sand
- 5 kg (l) of water
- 1 kg (l) of water
- 1,5 kg (l) of water

(ii) Mix the cement and sand to a uniform colour on a non-absorbent surface.

(iii) Mix, in succession, each of the amounts of water (5 l, 1 l and 1,5 l) until the mix reaches a consistence suitable for plaster.

If 5 l of water is enough the sand is of good quality,

If 5 l + 1 l is enough the sand is of average quality,

If 5 l + 1 l + 1,5 l is enough, the quality of the sand is poor, and

If more water than that is required, the quality is very poor.

Only “Good” sands are suitable for use in all plaster work;

“Average” sands may be used for interior plaster; and

“Poor” and “Very poor” sands are not recommended and should be avoided.

(iv) Assess the workability of the mix (at plastering consistence) by forming a flattened heap about 100 mm high and 200 mm in diameter on a non-absorbent surface. Place a plasterer’s trowel face down on top of the heap and try to push the trowel down.

A workable plaster will squeeze out from under the trowel and it will be possible to push the trowel to within a few millimetres of the underlying surface.



An unworkable mix will “lock up” once the trowel has moved a few millimetres and prevent further downward movement of the trowel.

If the mix appears to be workable, pick up some of the plaster on a trowel then tilt the trowel. The plaster should slide off easily. If it clings to the trowel the mix is too “fatty”, an indication of excessive clay content of the sand.

### 3.3 Workability improvers

These materials may be used in cases where a mixture of sand and Portland cement only does not have satisfactory workability, usually because of a deficiency in the sand.

Workability is improved by increasing the amount of very fine material in the mix, entraining air in the mix, or a combination of these.

The following materials are used as workability improvers:

#### Hydrated builder’s lime

This is in the form of very fine plate-like particles. The amount added to the mix may be as much as the amount of cement (by volume, see Table 2). Only hydrated lime complying with SANS 523 : 2002 Limes for use in building should be used. Use type A2P if possible for better plasticity.

**Note** that the limes used in South Africa do not have cementing properties. They cannot therefore be used to replace cement but are used in addition to Portland cement.

#### Air-entraining agents (AEAs)

These are chemical admixtures that cause millions of tiny air bubbles to be entrained in the mix. Accurate dosage is essential because over-dosage results in excessive air entrainment with consequent loss of strength. Because dosage is difficult to control on site, the dosing of AEAs on site is not recommended.

#### Masonry cement

These products comprise a blend of Portland cement, ground limestone or hydrated lime and an AEA. Masonry cements are normally used in plaster as a substitute for Portland cement.

Plasters made with masonry cement will have lower strength than those made with Portland cement at the same ratio of sand to cement. For similar strength therefore, masonry cement mixes should be richer than Portland cement mixes (see Table 2).

Note: Builder’s lime and AEAs should not be used with masonry cement.

#### Important Note

Gypsum-based plaster should never be mixed with a plaster made with portland cement. This is because gypsum is a sulphate compound which attacks

### 3.4 Bonding agents

These are specially formulated water-based emulsions of polymers such as styrene butadiene rubber (SBR), acrylic, and polyvinyl acetate (PVA). They are used as a part replacement for mixing water in spatterdash coats (see Roughness in section 5.2).

Emulsions become effective by coalescing which happens only when the mixture dries out. Uncoalesced emulsions can be leached out of the mix by water. Mixes containing an emulsion should therefore be cured by maintaining

moist conditions and not by applying free water; they must then be allowed to dry out before being exposed to wet conditions.

Polymer emulsions must not be used on their own because they may form a plastic skin that will act as a debonding agent. Note also that PVA should be used only for plasterwork that will be permanently dry in service. (This is because PVA is unstable in moist conditions.)

#### 4. Mix proportions

Mix proportions for conventional plaster are shown in Table 2.

#### 5. Surface preparation

This section deals with the preparation of the surface to which the plaster is applied, i.e. the substrate. Aspects discussed are substrate properties; techniques of surface preparation; and methods of preparing different types of surface.

##### 5.1 Surface properties required for successful plastering

The surface to be plastered should be accurately positioned overall and zones should not deviate excessively from a plane (or curved) surface. Ideally, the substrate should be rough; absorbent to a limited extent; strong; and clean, i.e. free of any film, such as dust, oil or paint, that could impair bond between plaster and substrate.

Plaster thickness should be as recommended (see section 6.3) and as uniform as possible. The more accurate the substrate the easier it is to meet these requirements.

Roughness improves adhesion by providing a positive “key” for plaster to grip. Absorption removes the water film, between substrate and plaster, that would tend to weaken adhesion. Excessive absorption will however dry out the plaster (see Absorption in section 5.2). The strength of the substrate material should be greater than, or equal to, that of the hardened plaster.

##### 5.2 Techniques of preparing surfaces

###### Accuracy

In new work, surface preparation starts with accurate setting out and construction of walls and soffits.

The aim should be to provide a surface that can be plastered to the required lines and levels by applying a coat (or coats) of uniform thickness. Excessively thick plaster, or plaster of uneven thickness should not be relied on to hide inaccurate work.

Where zones of the substrate surface deviate from the required plane (or curved) surface by more than about 10 mm, the first option is to remove high areas by hacking or cutting. If this is not practicable, apply undercoats to low areas in such a way that the final coat is of uniform thickness (see section 6.3).

In cases where overall thickness exceeds the recommendations given in section 6.3, it is advisable (and safer) to mechanically anchor the plaster to the substrate, e.g. with stainless steel studs. This is also recommended when plastering dense non-absorbent substrates.



Strength

For new work, masonry units strong enough to survive handling and transport prior to being built in should be strong enough to hold plaster. Similarly, in situ concrete should have ample strength.

In some cases, it is necessary to plaster existing walls of soft clay brick. Methods of plastering such surfaces are discussed later (see section 5.4).

Appendix 4 - Table 2: Mix proportions for plaster

Description	Using common cement			Using masonry cement	
	Cement <sup>1</sup> kg	Hydrated builder's lime <sup>2</sup> kg	Sand, measured loose and damp litres	Masonry cement <sup>3</sup> kg	Sand, measured loose and damp litres
Mix A Foundation walls, constantly damp conditions, aggressive soils	50	0-10	130	50	100
Mix B Exterior and interior plaster above DPC level	50	0-25	200	50	150
Mix C Plaster applied to a very weak substrate, e.g. poorly burnt or sundried clay brick	50	0-80	300	50	200

1. Complying with SANS 50197-1 strength classes 32,5 and 42,5 only.
2. A 25 kg bag of lime has a nominal volume of 40 litres.
3. Complying with SANS 50413-1; strength class 22,5X.

Roughness

Background surfaces should ideally be at least as rough as coarse sandpaper or rough-sawn timber.

Surface roughness can be achieved in one of the following ways:

- Using formwork with a rough surface, e.g. sawn timber for concrete
- Stripping formwork early and wire brushing concrete
- Hacking
- Abrasive blasting (e.g. sand blasting)
- Applying a spatterdash layer

Spatterdash is a mixture of one part of cement to one and a half parts of coarse sand with enough water for a sluggishly pourable consistence. A polymer emulsion may be substituted for part of the mixing water (usually a quarter to a third, but in accordance with the manufacturer's instructions). The mixture is thrown forcibly on to the wall, using a scoop or a brush with long, stiff bristles. (The impact drives out the water film at the interface between spatterdash and substrate and hence improves adhesion.)The spatterdash should cover the substrate surface completely and form a rough texture with nodules about 5 mm high.

Spatterdash must not be allowed to dry out for at least three days. (See comments on curing in section 3.4 if a polymer emulsion is included in the mix.) It should be tested for adhesion and strength by probing with a screwdriver or knife before plaster is applied to it.

### **Cleanliness**

Surfaces must be free of loose material, such as dust, and films that can interfere with bonding, such as curing compounds.

Background surfaces may be cleaned by:

- Water jetting
- Blowing with (oil-free) compressed air
- Vacuum cleaning

Solvents should not be used to remove films formed by curing compounds. (Such films must be removed by mechanical means.)

### **Absorption**

First assess absorptiveness by throwing about a cupful of water against the surface.

The surface will fall into one of the three categories:

I No water is absorbed.

II Some water is absorbed but most runs off.

III Most of the water is absorbed.

Category I surfaces, which would include hard-burnt clayface bricks, glazed bricks and very dense high-strength concrete, should be prepared by applying a spatterdash coat that includes a polymer emulsion. Such surfaces must not be pre-wetted.

Category II surfaces should not require any treatment to control suction.

Category III surfaces should be wetted thoroughly and then allowed to become surface dry before the plaster is applied.

## **5.3 Preparation of various types of substrate**

### **Monolithic concrete**

Concrete is normally placed in situ but may be precast.

Provide a rough surface by using rough-textured formwork, early stripping of formwork and wire brushing the concrete, hacking or abrasive blasting. (If none of these is practicable, apply a spatterdash coat after ensuring that the surface is clean.)

Ensure that no form-release oil is left on the surface to be plastered. Clean down by water jetting or vacuuming. Remove curing compound, if any, by mechanical means. Conventional structural concrete should not require wetting to control suction. High-strength concrete may require the application of a spatterdash coat.

### **Concrete masonry**

The texture of the masonry units should be sufficiently rough without further treatment. If not, apply a spatterdash coat.



If the surface is dusty, clean by brushing, water jetting or vacuuming.

It should not be necessary to control suction of the surface by pre-wetting, unless the masonry units are very absorbent.

### **Burnt clay stock brickwork**

The texture of the bricks should be sufficiently rough without further treatment. If not, apply a spatterdash coat. If the surface is dusty, clean by brushing, water jetting or vacuuming.

Burnt clay stock bricks normally have a very high suction; this can be assessed by wetting the wall (see Absorption in section 5.2). If suction is high, pre-wet the wall and allow it to become surface dry before applying the plaster.

### **Burnt clay face-brickwork**

Such walls are characterized by low suction. Brick texture may be smooth, almost glazed, or rough.

Provide a key by cutting out mortar joints about 10 mm deep. (A key would not normally be made while the wall is being built because there is no point in using facebricks if the wall is to be plastered.)

If the brickwork has been treated with a sealer or waterproofing agent, the surface layer containing this treatment must be removed.

Apply a spatterdash coat if the brick surface is smooth. Rough bricks should not require this. It is normally not necessary, or advisable, to pre-wet the wall before plastering.

### **Sundried or poorly burnt soft clay brickwork**

This type of walling may be found in very old buildings, usually when restoration or repairs are being done.

Care should be taken when removing the old plaster so as not to damage the bricks. Protect the wall from rain or running water once the bricks are exposed.

Rake out the joints about 10 mm deep (the mortar is normally very soft).

Brush down the wall to remove any loosely adhering material.

Lightly dampen the wall and apply a spatterdash coat that incorporates a polymer emulsion to improve adhesion.

## **6. Application**

### **6.1 Batching**

Batching sand by loose volume is satisfactory. Batches based on whole bags of cement are preferable. The size of the batch should, however, be small enough for it to be used up within about two hours.

### **6.2 Mixing**

This may be done by machine or by hand. Machine mixing is preferable.

Hand mixing should be done on a smooth concrete floor or steel sheet. First spread out the sand about 100 mm thick.

Spread the cement uniformly over the sand.

Mix sand and cement until the colour is uniform. Then gradually add water while mixing until the right consistence is reached.

### **6.3 Plaster thickness**

Recommended thicknesses are:

First undercoat: 10–15 mm

Second undercoat (if any): 5–10 mm

Finish coat: 5–10 mm

If plaster is applied in a single coat, thickness should be 10–15 mm. A single coat should not be thicker than 15mm.

### **6.4 Applying the plaster**

Never work in direct sun. Plastering should be protected from the sun and drying winds.

The plaster should be used up within two hours of being mixed and never be re-tempered by mixing in additional water.

Ensure that plaster is not continuous across the line of a damp-proof course. Plaster should be cut through to the substrate where different substrate materials meet, e.g. masonry and concrete.

#### **The general procedure for applying plaster is as follows:**

For accurate work, apply screed strips before the wall is plastered. These are narrow strips of plaster along the perimeter of the wall, or at suitable intervals on the wall, that act as guides for the striker board.

Using a rectangular plasterer's trowel, push plaster onto the wall or ceiling using heavy pressure to compact the plaster and ensure full contact with the substrate. The plaster should be slightly proud of the intended surface.

Once the plaster starts to stiffen, it should be struck off to a plane (or curved) surface using a light striker board. Material removed in this way should be discarded.

If plaster is to be applied in more than one coat, the undercoat(s) should be scored with roughly parallel lines about 20 mm apart and 5 mm deep. The purpose of scoring is twofold: to provide a key for the next coat and to distribute cracking so that it is less noticeable.

For the final coat, use a wood float to remove ridges made by the striker board. At the same time fill in any depressions and float flush with the surrounding plaster.

If a very smooth texture is required, a steel trowel may be used on the surface. Such surface is however not generally recommended because it tends to craze and show up imperfections.

Various decorative finishes are also possible. Techniques include brushing, flicking plaster onto the surface and lightly floating, etc.

#### **In the special case of soft clay brickwork, plaster should be applied as follows:**

Using mix C (see Table 2) with the maximum amount of lime, fill major depressions in the wall and scratch well.





If mesh reinforcement or metal lathing is to be used, nail it to the wall using galvanized nails driven through the spatterdash coat and use spacers to keep it away from the wall. Apply the first coat of plaster, again using mix C with the maximum amount of lime. This first coat is used to achieve a plane surface. (In some cases it is necessary to use two coats to achieve this.)

It must be well scratched, cured for at least two days and allowed to dry. The scratching, followed by the drying period, distributes shrinkage cracks. Apply the final coat of plaster, using the same mix C or preferably a slightly leaner mix. Striking off and finishing are done as described previously.

### 6.5 Accuracy

The permissible deviations of plaster work are 3 and 6 mm under a 2 m straightedge for grades I and II finishes respectively (SANS 10155 : 1980 *Accuracy in buildings*).

Experience has shown that a grade I finish on masonry walls is not achievable with one-coat plaster work unless the masonry units have only small dimensional differences and the accuracy of the wall is excellent.

## 7. Specifications

Specifications for plaster work should cover the following aspects: selection of materials, mix proportions, application, finish and surface tolerances.

## 8. Conclusion

Provided sufficient attention is paid to the selection of materials, mix proportions, preparation of substrate surfaces and the application of the plaster, the results should be serviceable and aesthetically acceptable.

**Note:** For information on plaster defects and their causes, refer to *Common defects in plasters* available from the Cement and Concrete Institute.









**International Labour Organization**

P. O. Box 11694

Hatfield

Pretoria 0028

South Africa

Tel: +27-(0)12 818 8000

Fax: +27-(0)12 818 8087

e-mail: [pretoria@ilo.org](mailto:pretoria@ilo.org)

[asare@ilo.org](mailto:asare@ilo.org)