

SAFETY & HEALTH

at the motor vehicle repair shop

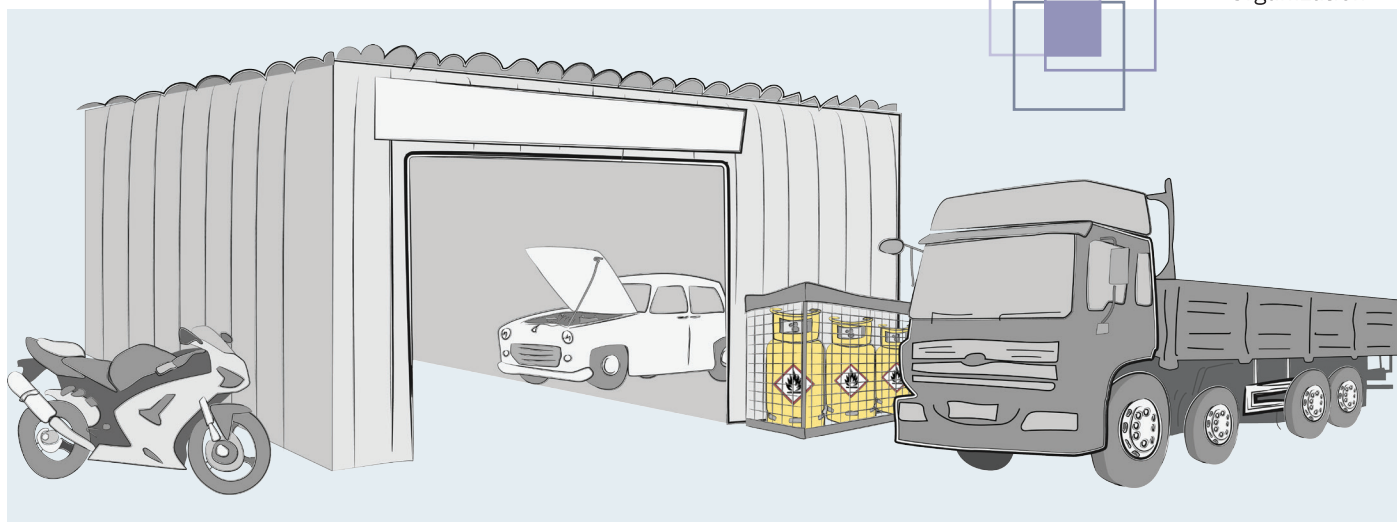

International
Labour
Organization



On a daily basis your garage provides many services to your clients. Consider, for example vehicle maintenance and tyre repair. In providing these services, you carry out tasks like draining fuel and handling dangerous substances. These tasks expose you to many hazards and you and your co-workers could be at risk.

Hazards like fires and explosions can cause you to be seriously injured or even killed. You could be crushed by a vehicle falling as you're working under it. You are exposed to other hazards like waste oils and cleaning materials, along with explosive forces related to the compressed air within tyres.

This information sheet explains what you can do in certain instances to reduce the chances of suffering from occupational accidents and diseases. Remember though, that there are many other hazards you are exposed to other than the ones we cover here and additional precautions may be required in certain situations, for instance pregnancy. So before you start any task, stop and ask yourself:

1. How will I do the work?
2. Do I know enough to remain safe and healthy?

All workers must be informed and trained on the hazards and the safe systems of work that should be followed in the garage. Let's look at some precautions when working with certain hazards.

Please also contact your local labour inspectorate or occupational safety and health authority to help you understand the hazards and what precautions to take.

TYRE REPAIR

You can be seriously injured while you're repairing or replacing tyres. These accidents not only occur because of a falling vehicle but also due to bursting tyres. When a tyre bursts, energy (compressed air) is violently released through the sidewall and towards workers. The chance of a tyre failing is even higher if the tyre has been damaged or following a repair.

Inflate the tyre with airline hoses that are long enough to enable you to stand outside the likely path of any explosion.

If the tyre bursts you will not be in the path of the explosive force.

Airline hoses should have quick release couplings for connection with the tyre and at the operators working position.

To ensure that the coupling does not have to be held in place by the operator and that the pressure can be released from a safe working position.

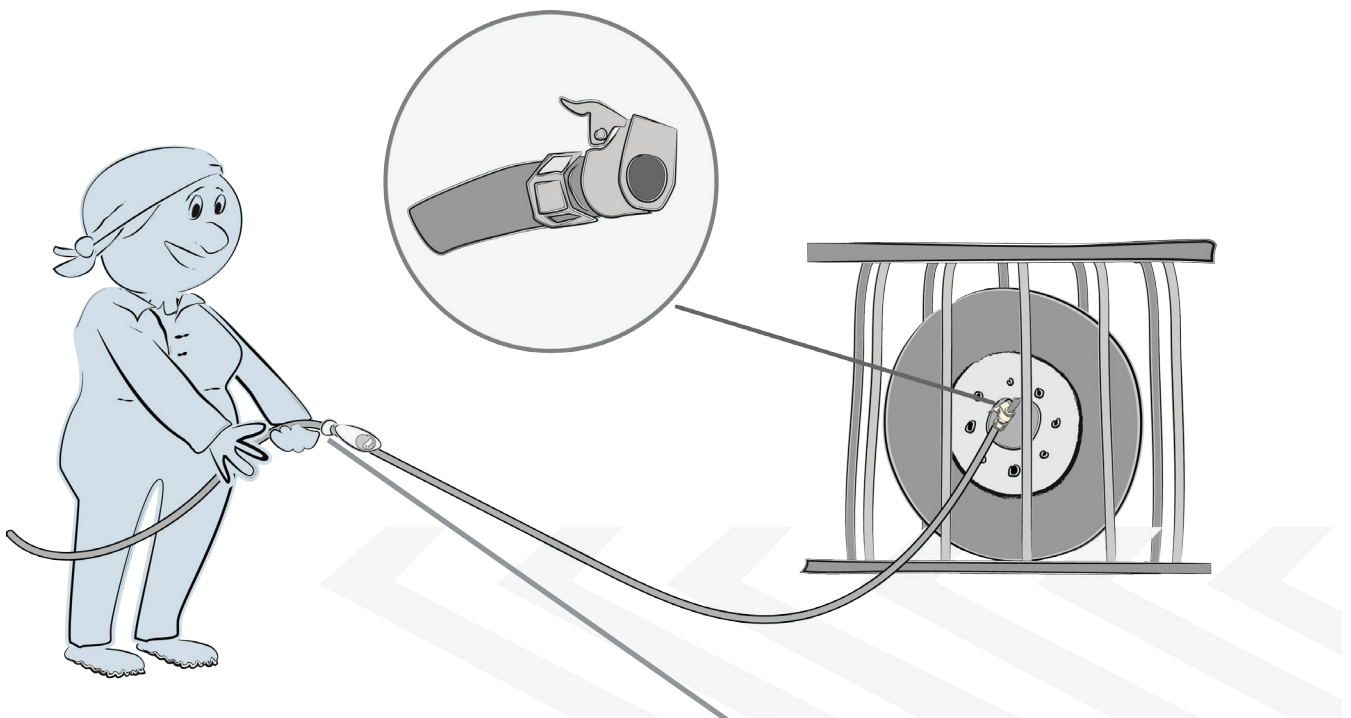

Inflate commercial tyres within a cage or clamped to the floor or other restraining devices.

To confine tyres and their components if the tyre explodes.

Pressure gauges should be fitted to the air lines.

To ensure that tyres are not over pressurised.

Multi-piece wheels and divided wheels must be reassembled with utmost care and you should follow manufacturer's guidance in addition to the above safe systems of work.

FIRE AND EXPLOSIONS

Fires and explosions are very common in garages. As a result, garages/workshops are damaged and people working there may be seriously injured or killed.

Three things (or “elements”) are needed to start a fire: oxygen, an ignition source (heat) and flammable material (fuel). Because all three elements are present in a garage, workers must follow safe systems of work to ensure that the three elements remain separated.

Keep the quantity of flammable substances (petrol, cleaning substances etc.) to a minimum.

This reduces fuel for a fire.

Store flammable liquids in stable sealed containers.

To prevent spillage and flammable vapours being released.

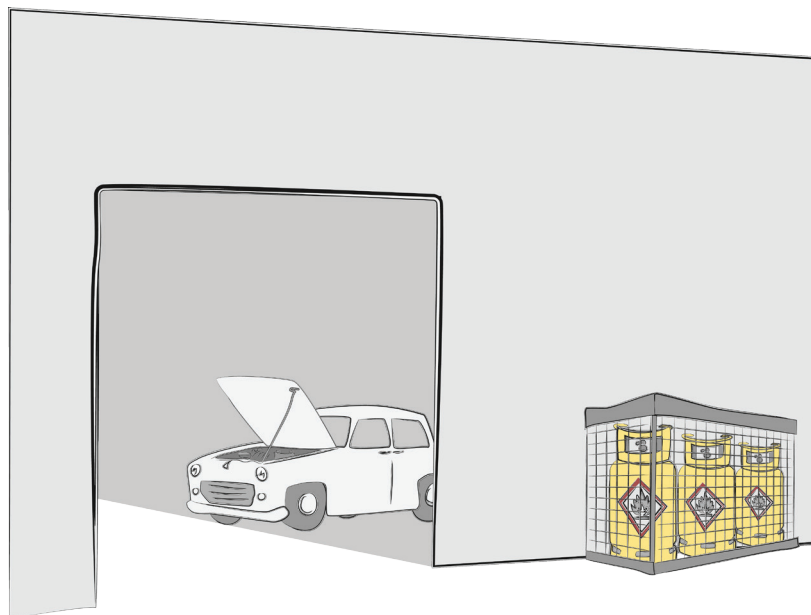

Store gas cylinders outside buildings in secure cages.

So any gas leaks are dispersed.

Never use thinners/paints or petrol to light rubbish fires.

Because the vapours can burn instantaneously in an uncontrolled manner and injure you.

Carry out hot work (welding and flame cutting) away from flammable material.

To prevent the heat generated by such work igniting the flammable material.

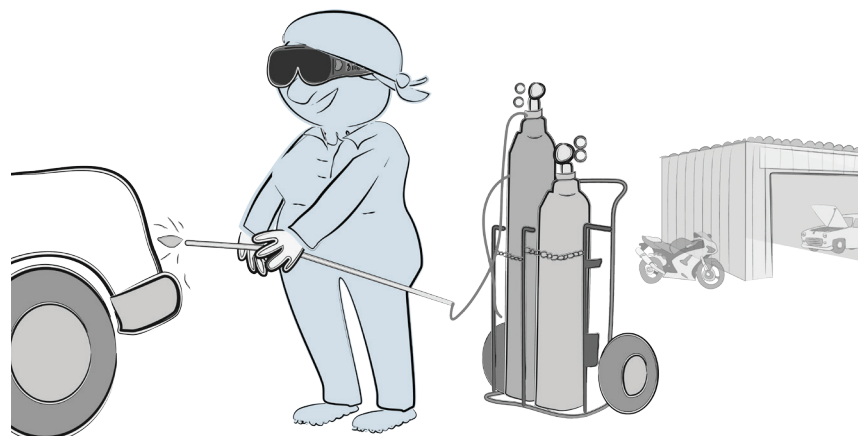

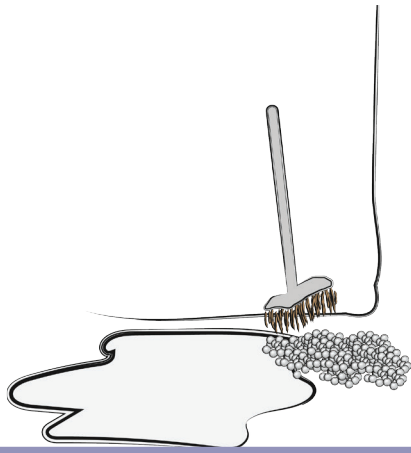

Clean oil spills, tidy away used oil filters, rags and paper and store them in fire resistant containers e.g. a metal bin with a lid.

Because good housekeeping reduces risks of fires and explosions.



To reduce chances of fire when you need to drain petrol from a vehicle:

Use a fuel retriever.

This minimises the presence of highly flammable petrol vapours and provides a suitable container to collect the petrol in.

Disconnect the vehicle's battery.

To remove an ignition source.

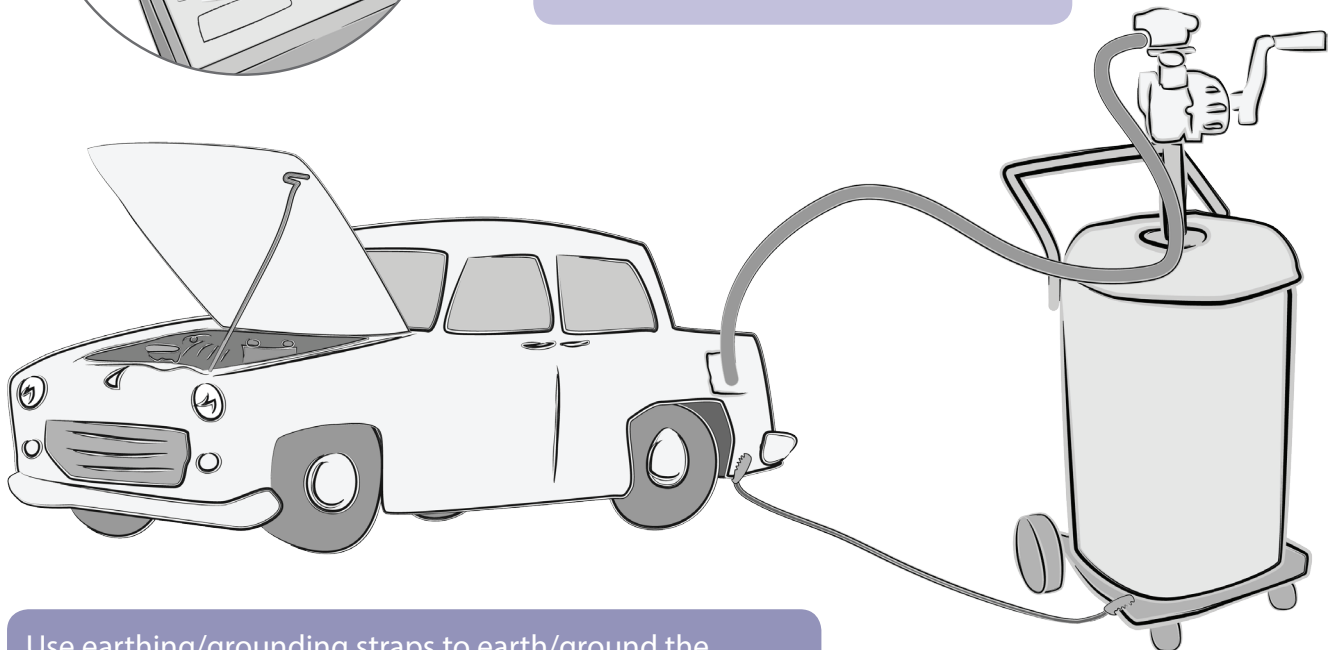

Use earthing/grounding straps to earth/ground the vehicle and fuel retriever.

To eliminate static electrical discharge as an ignition source.

Keep a foam or dry powder fire extinguisher present and ensure you know how to use it.

To put out fires quickly and prevent them from spreading through the workplace.

Work in well ventilated areas.

So an explosive atmosphere is not created.

Tell your colleagues what you are doing.

To avoid unnecessary exposure.



If you must drain petrol without a retriever then, in addition to the precautions above, make sure to:

Use a hand-operated siphon or independent manual pump (not electrically operated) with transfer pipework at both ends.

To minimise spillage and potential static electrical discharges.

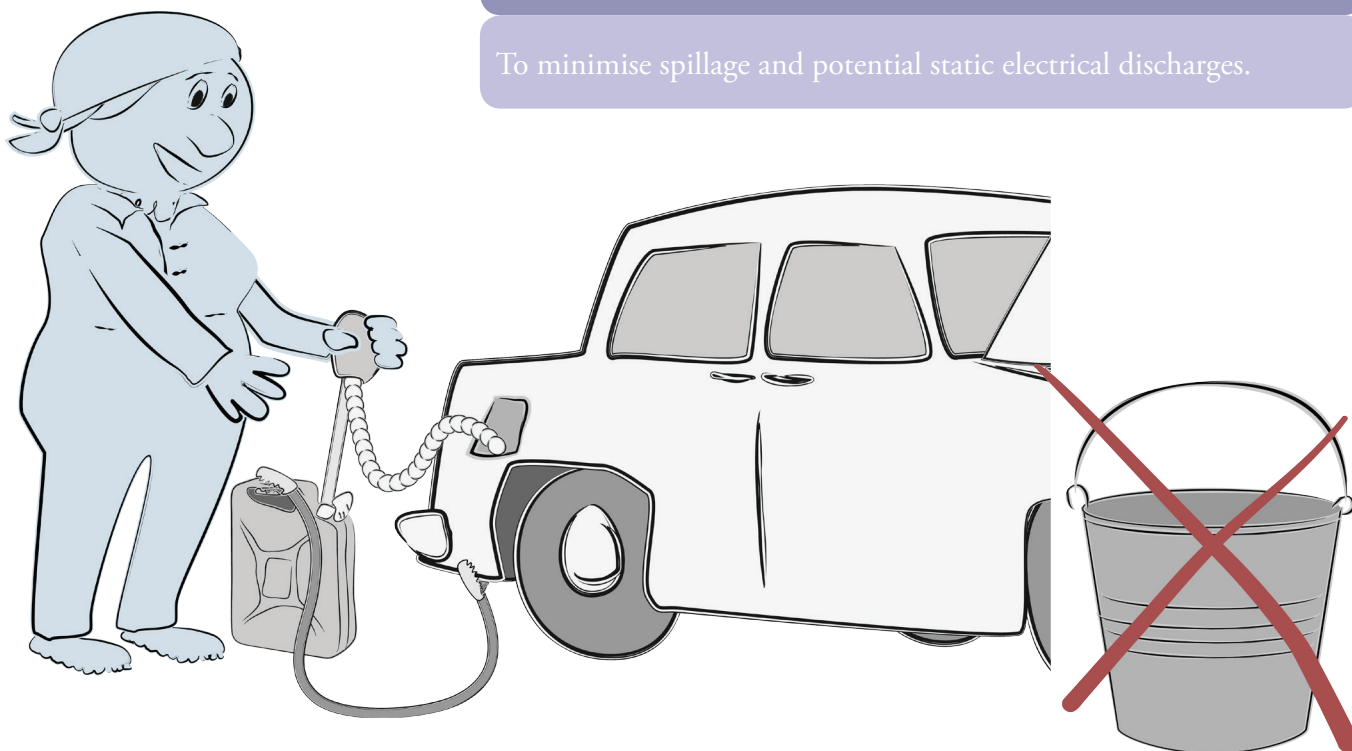

Use earthing straps to earth/ground the vehicle chassis and container.

To eliminate static electrical discharge as an ignition source.

Use a suitable stable metal container that can be securely closed.

To reduce the risk of spillage and prevent petrol vapour from escaping.

Working under VEHICLES/TRAILERS

You are at risk when you are working underneath vehicles, raised tipping trailers or vehicle cabs. You are under a large weight that, if not stable or supported, may fall and crush you. When you work under a vehicle in an inspection pit there is also a risk that flammable liquids and vapours may accumulate in the pit and catch fire.

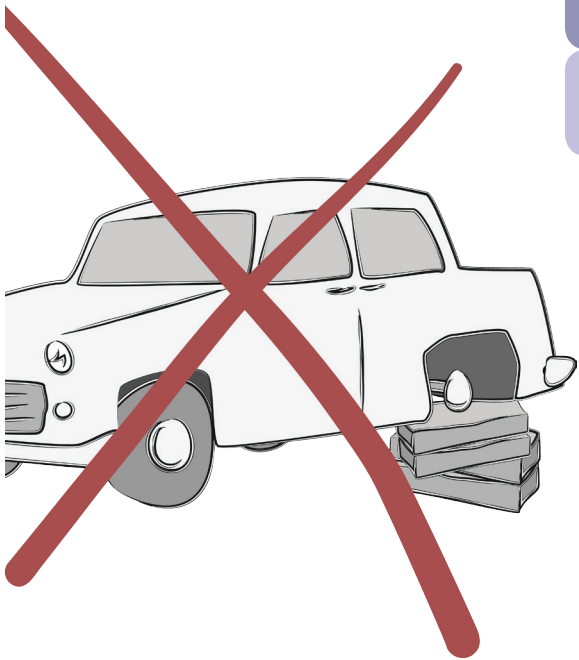

Use correct and maintained equipment to raise a vehicle and support it, e.g. vehicle jacks and axle stands.

A vehicle supported on inappropriate equipment may fall and crush you.

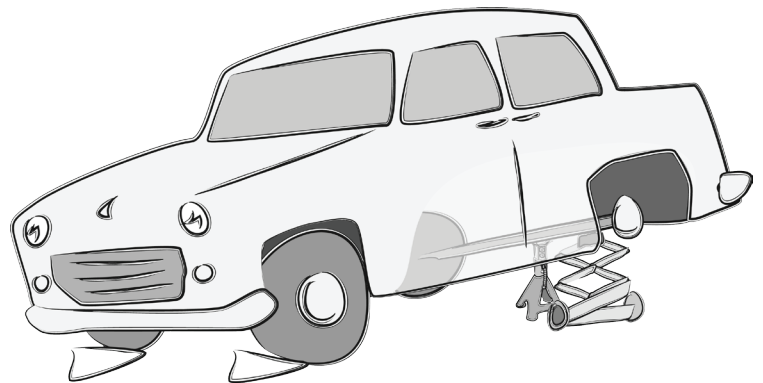

Place the jacks and axle stands under a strong part of the vehicle.

So the vehicle does not collapse onto them and workers underneath.

Ensure that vehicle handbrake is applied and the wheels remaining on the ground have been secured.

To prevent the vehicle moving and falling off any support.

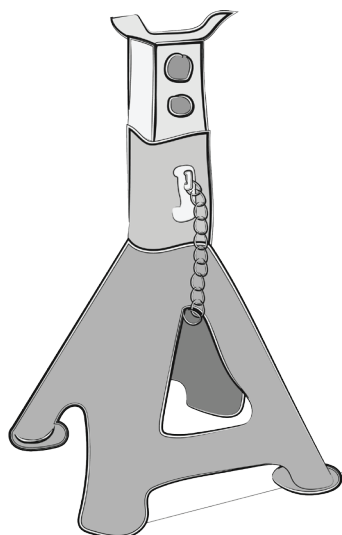

Ensure that the axle stand pins are of the correct specification (not bolts or screwdrivers).

To ensure the axle stand will remain at the correct height.

Use the jacks and axle stands on flat level ground.

To ensure they will not slip or fall.

When using 2 post vehicle lifts:

- Raise the vehicle to about one metre
- Ensure the lifting pads are in the correct position
- Rock the vehicle before lifting it higher

This ensures that the vehicle is correctly balanced and solidly held before you start working under it.

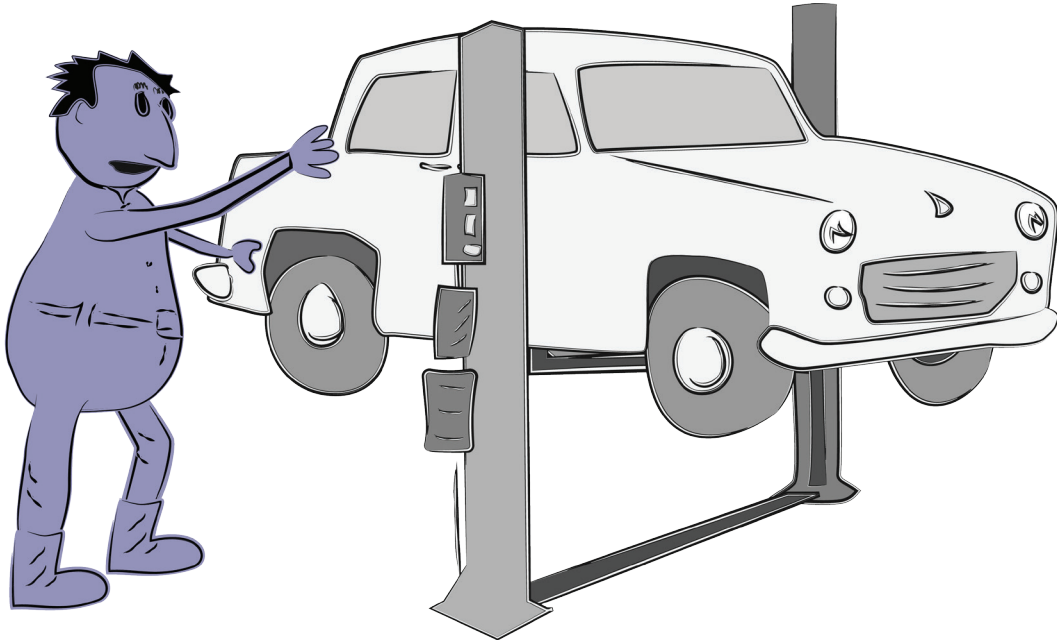

Before removing heavy vehicle parts ensure that this will not affect the vehicle's stability.

These checks prevent the vehicle from falling off the lift.

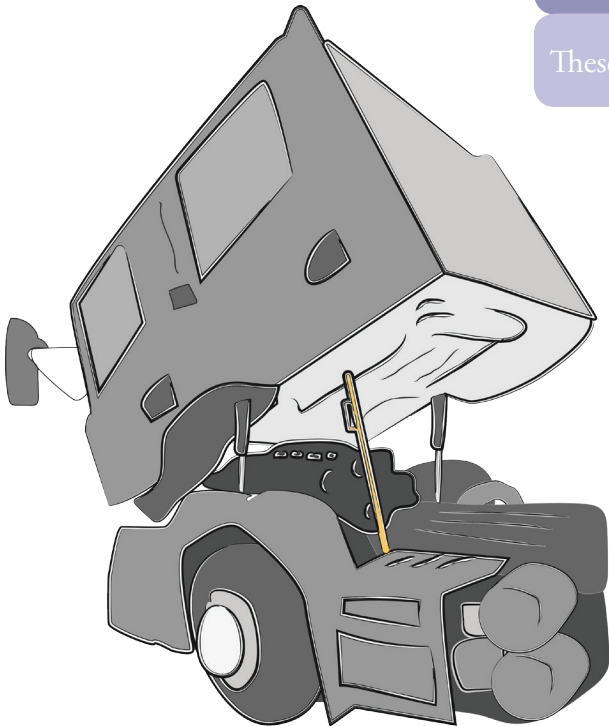

When you work on raised tipping trailers or vehicle cabs you should ensure that additional supports are in position to prevent the trailer or cab descending and crushing workers. This is because the rams to lift the loads cannot be guaranteed to keep the load raised while workers are underneath.

HAZARDOUS SUBSTANCES

While you maintain and repair motor vehicles you are exposed to hazardous substances e.g. waste oils, cleaning materials, petrol and diesel, gases contained in air conditioning systems, battery acids etc. You need to control exposure to these substances.

Prevent exposure to vehicle fumes.

To avoid your eyes and respiratory tract being irritated and the risk of lung diseases.

Do not run engines in closed workshops.

To avoid exhaust fumes reaching harmful concentrations.

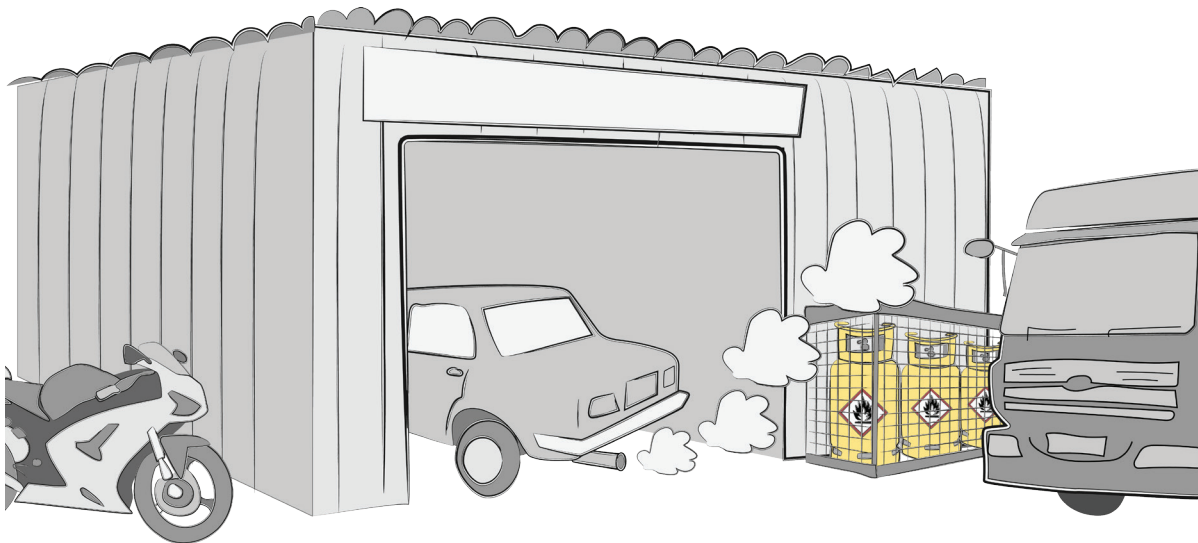

If vehicles have to be run, minimise the running time and connect the vehicle's exhaust to extraction equipment.

To remove the fumes from the workplace.

If extraction equipment is not available open doors and windows to create an air flow.

To reduce build-up of exhaust fumes and exposure.

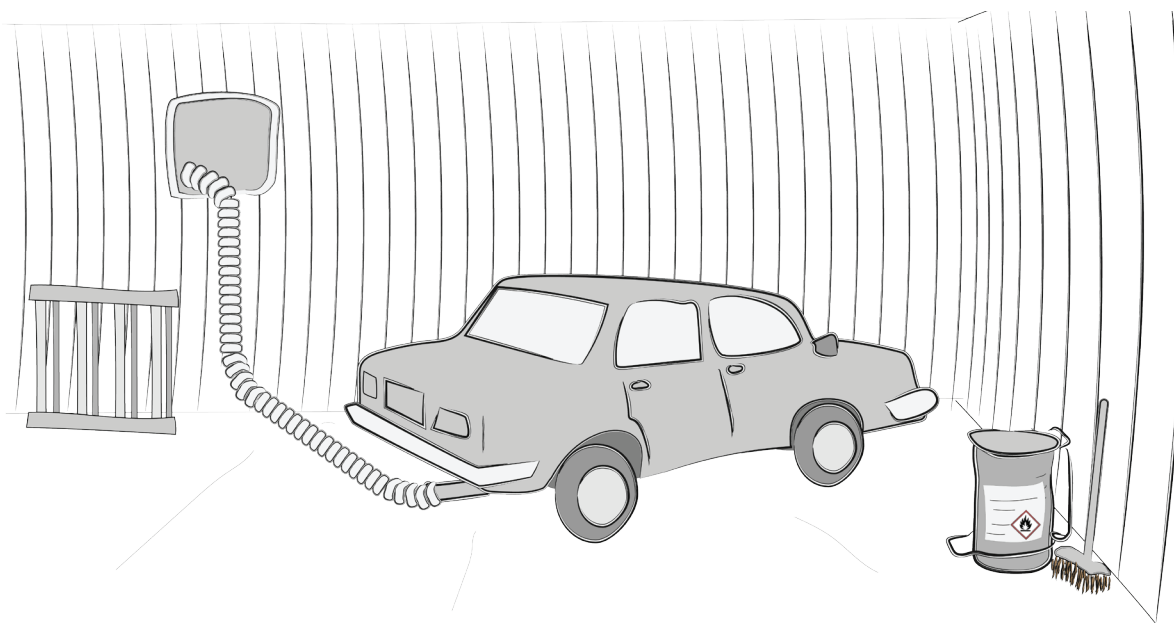

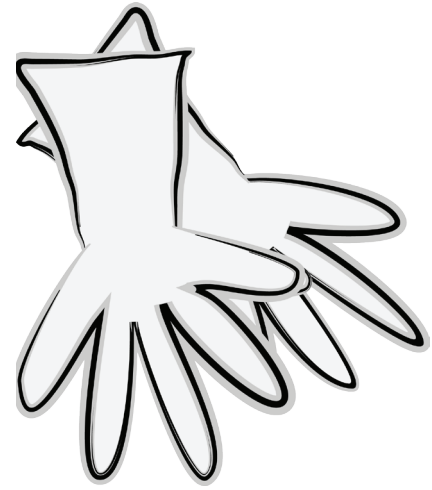
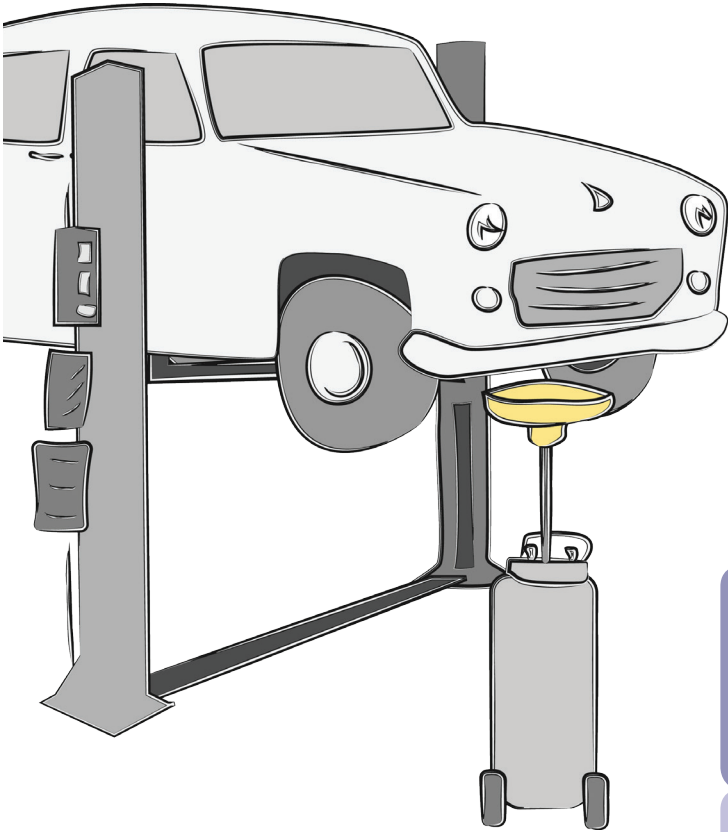

When draining waste oil:

- Use systems of collection
- Wear nitrile gloves
- Wash hands regularly
- Use hand lotion frequently

To reduce the risk of dermatitis and skin cancers.



Many car components may contain asbestos (a fibrous material) which if you inhale, can cause respiratory disease e.g. lung cancer. These include, for example, brakes, clutches, heat seals, and gaskets. Even if asbestos is banned in your country, old car parts can still contain it. Always assume these components contain asbestos unless you are certain they don't. When cleaning wheel and brake assemblies use a specialised vacuum cleaner fitted with an appropriate filter (tiny asbestos particles will pass through most filters). If this is not possible use clean wet rags to wipe out drums or housings and when finished immediately place them in a plastic bag and follow national legislation regarding disposal. Do not use airlines to blow the dust away or hit the brake drum with hammers as these methods further disperse asbestos particles into the air you breathe.